

DATA SHEET

METAL FILM RESISTORS

General Purpose

MFR Series

$\pm 0.5\%$, $\pm 1\%$, $\pm 2\%$, $\pm 5\%$

1/6W to 3W

RoHS compliant & Halogen Free





APPLICATIONS

- All general purpose applications
- Power applications

FEATURES

- AEC-Q200 qualified
- Wide resistance range
- PPAP ready (MFR-25/MFR50S/MFR-50)
- High stability
- RoHS compliant & halogen-free

ORDERING INFORMATION

Part number of the general purpose metal film resistor are identified by the series, power rating, tolerance, packing, temperature coefficient, forming and resistance value.

PART NUMBER

MFR **200** **F** **T** **F** **73-** **100R**
 (1) (2) (3) (4) (5) (6) (7)

(1) SERIES

MFR Series

(2) POWER RATING

-12 = 1/6W	-50 = 1/2W	200 = 2W
25S = 1/4W	100 = 1W	3WS = 3W
-25 = 1/4W	2WS = 2W	1WS = 1W
50S = 1/2W		

(3) TOLERANCE

D = ±0.5%	F = ±1%	G = ±2%
J = ±5%		

(4) PACKAGING

R = Reel Pack	T = Box Pack	B = Bulk
---------------	--------------	----------

(5) TEMPERATURE COEFFICIENT OF RESISTANCE

E=±50ppm/°C	F=±100ppm/°C	- = Based on spec
-------------	--------------	-------------------

(6) FORMING

26- = 26mm	F = F Type
52- = 52.4mm	FK = FK Type
73- = 73mm	FFK = F-form Kink
M = M-Type Forming	FKK = FKK Type
MB = M-form W/fla	MT = MT Type Forming
52A=52.4mm, ψd 0.4±0.02mm	FT = FT Type Forming
52B=52.4mm, ψd 0.45±0.02mm	PN = PANAsert
52C=52.4mm, ψd 0.5±0.02mm	AV = AVIsert
52G=52.4mm, ψd ≥ 0.6mm	FB=- FB- Type (for -25&50S)
52H=52.4mm , non-painting on soldering spots	

Note: 26mm, 52.4mm and 73mm represent dimension A of the axial type, please refer to the category of AXIAL/REEL TAPE SPECIFICATION for the detail.

(7) RESISTANCE VALUE

E24 & E96 & E192 Series
 Example:
 100R = 100Ω, 10K = 10,000Ω, 1M = 1,000,000Ω

DIMENSIONS

Unit: mm



	Normal	Miniature	L	ψD	H	ϕd
MFR-12	MFR25S	3.4 ± 0.3	1.9 ± 0.2	28 ± 2.0	0.45 ± 0.05	
MFR-25	MFR50S	6.3 ± 0.5	2.4 ± 0.2	28 ± 2.0	0.55 ± 0.05	
MFR-50	MFR1WS	9.0 ± 0.5	3.3 ± 0.3	26 ± 2.0	0.55 ± 0.05	
MFR100	MFR2WS	11.5 ± 1.0	4.5 ± 0.5	35 ± 2.0	0.8 ± 0.05	
MFR200	MFR3WS	15.5 ± 1.0	5.0 ± 0.5	33 ± 2.0	0.8 ± 0.05	

DERATING CURVE

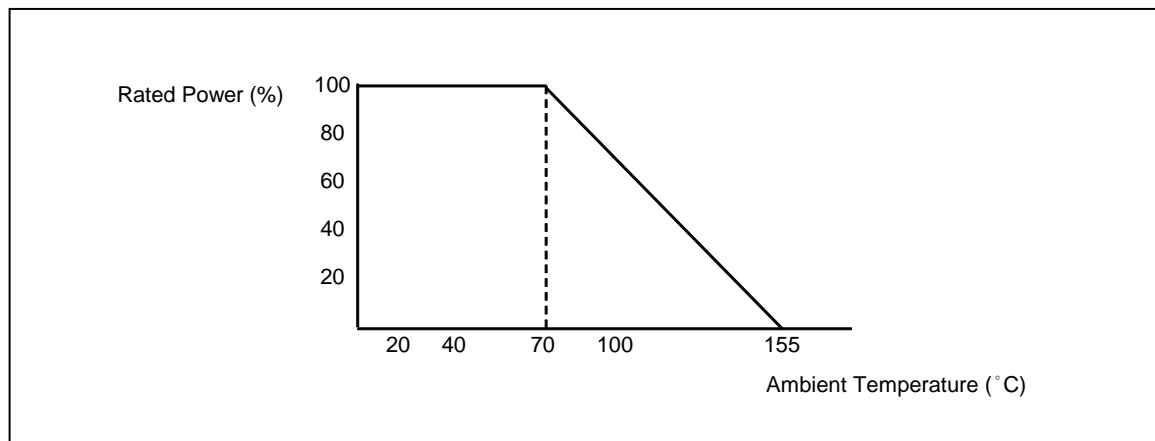

ELECTRICAL CHARACTERISTICS

CHARACTERISTICS	MFR-12	MFR25S	MFR-25	MFR50S	MFR-50	MFR1WS	MFR100	MFR2WS MFR200	MFR3WS
Power Rating at 70 °C	1/6W	1/4W	1/4W	1/2W	1/2W	1W	1W	2W	3W
Maximum Working Voltage	200V	200V	250V	300V	350V	400V	500V	500V	500V
Maximum Overload Voltage	400V	400V	500V	600V	700V	800V	1000V	1000V	1000V
Voltage Proof on Insulation	300V	400V	500V	500V	500V	700V	1000V	1000V	1000V
Resistance Range	1Ω ~ 4M7Ω for E24 & E96 series value								
Operating Temp. Range	- 55°C to +155°C								
Temperature Coefficient	±50ppm/°C , ±100ppm/°C								

Note: For resistance value out of above range is by request.

TEST AND REQUIRMENTS

TEST	TEST METHOD	PROCEDURE	APPRAISE
Short Time Overload	IEC 60115-1 4.13	2.5 times RCWV for 5 sec.(Not more than maximum overload voltage)	±0.25%+0.05Ω
Voltage Proof on Insulation	IEC 60115-1 4.7	In V-Block for 60 sec. test voltage as above table	No Breakdown
Temperature Coefficient	IEC 60115-1 4.8	Between -55°C to +155°C	By Type
Insulation Resistance	IEC 60115-1 4.6	In V-Block for 60 sec.	>10,000MΩ
Solderability	IEC 60115-1 4.17	245±5°C for 3±0.5 Sec.	95% Min. coverage
Solvent Resistance of Marking	IEC 60115-1 4.30	IPA for 5±0.5 Min. with ultrasonic	No deterioration of coatings and markings
Robustness of Terminations	IEC 60115-1 4.16	Direct load for 10 Sec. in the direction of the terminal leads	≥2.5Kg(24.5N)
Periodic-pulse Overload	IEC 60115-1 4.39	4 times RCWV 10,000 cycles (1 Sec. on, 25 Sec.off)	±1.0%+0.05Ω
Damp Heat Steady State	IEC 60115-1 4.24	40±2°C,90-95% RH for 56 days, loaded with 0.1 times RCWV	±1.5%+0.05Ω
Endurance at 70°C	IEC 60115-1 4.25	70±2°C at RCWV(or Umax., whichever less) for 1,000 Hr.(1.5 Hr.on,0.5 Hr. off)	±1.5%+0.05Ω
Temperature Cycling	IEC 60115-1 4.19	→ -55°C → Room Temp. → +155°C Room Temp.(5 cycles)	±0.75%+0.05Ω
Resistance to Soldering Heat	IEC 60115-1 4.18	260±3°C for 10±1 Sec., immersed to a point 3±0.5mm from the body	±0.25%+0.05Ω

Note:

RCWV (Rated Continuous Working Voltage):

The DC or AC (rms) continuous working voltage corresponding to the rated power is determined by the following formula:

$$V=\sqrt{(P \times R)}$$

or max. working voltage whichever is less

Where

V=Continuous rated DC or
AC (rms) working voltage (V)

P=Rated power (W)

R=Resistance value (Ω)

PULSE DIAGRAMS

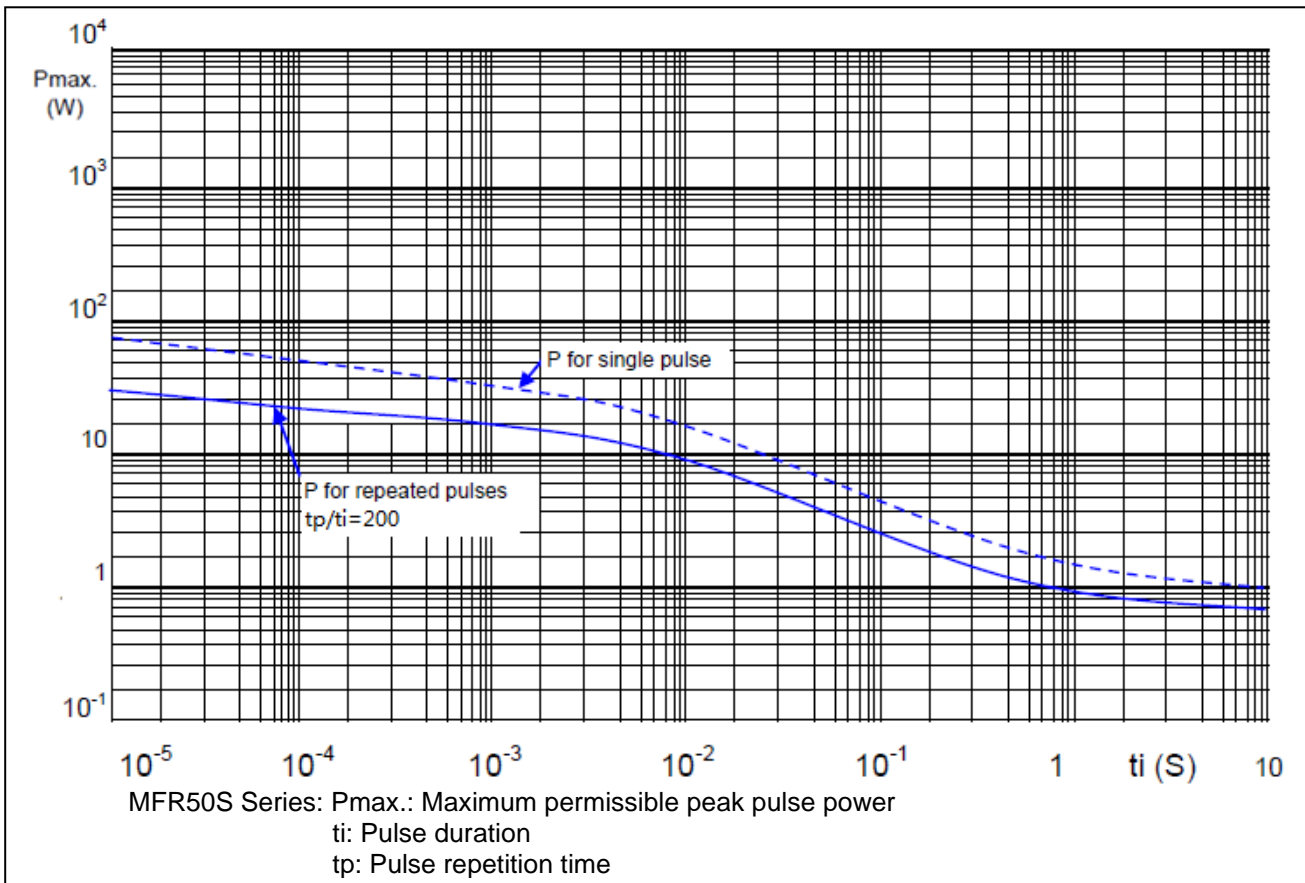
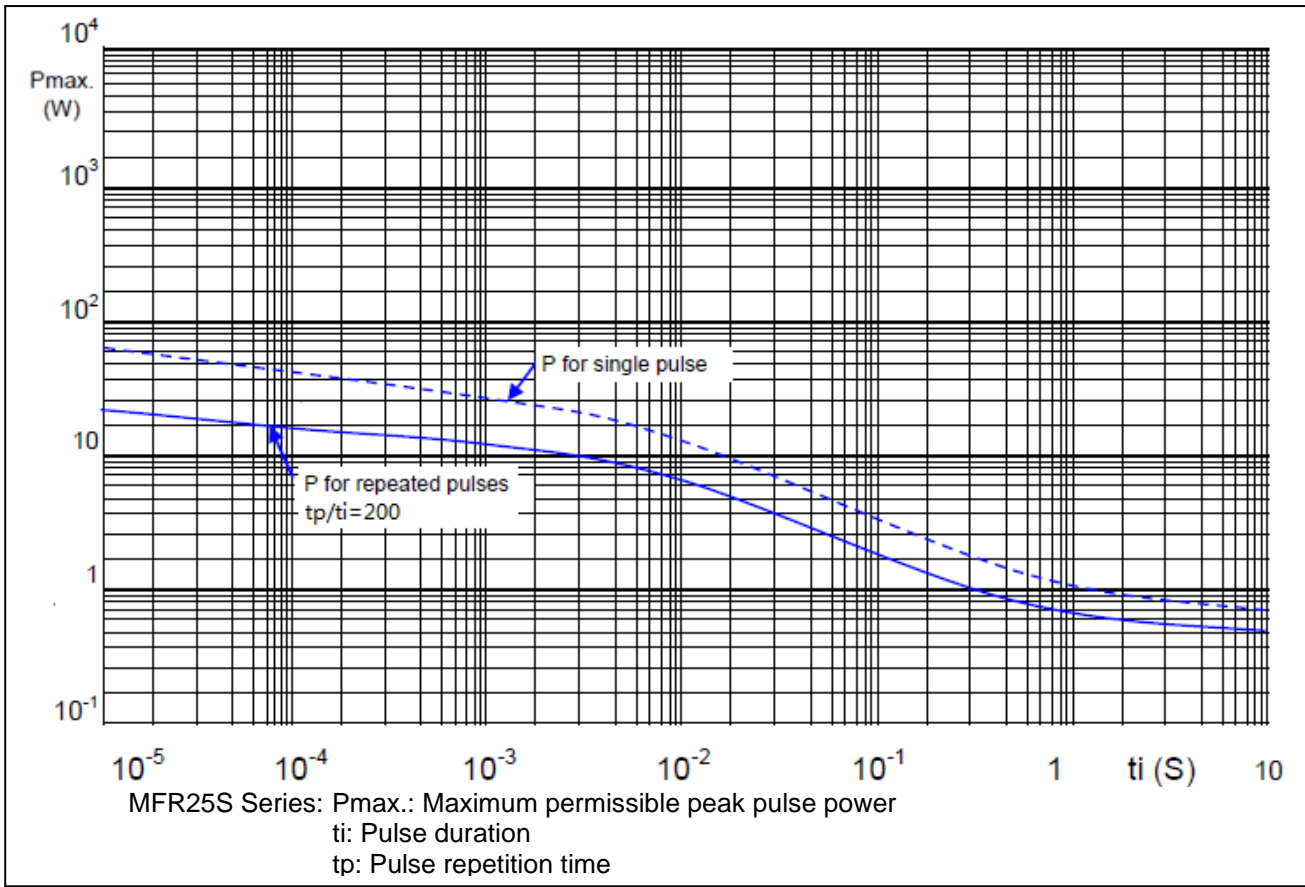

AXIAL / REEL TAPE SPECIFICATION

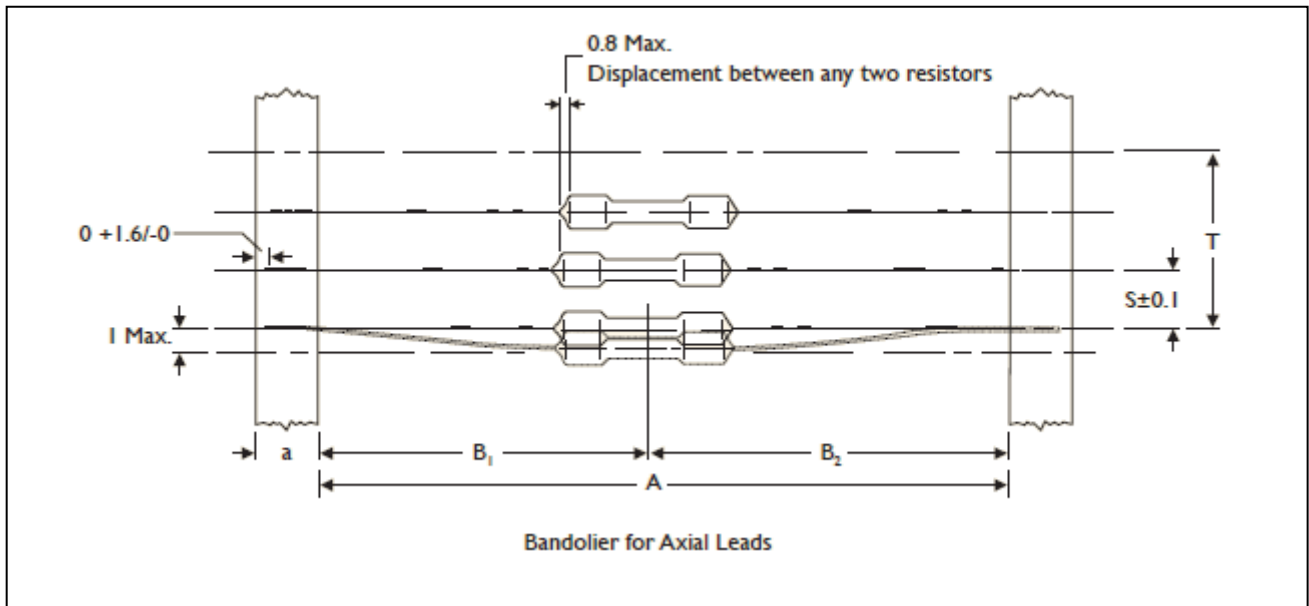

Unit: mm

Normal	Miniature	a	A	B1-B2 (Max.)	S (spacing)	T (max. deviation of spacing)
MFR-12	MFR25S	6 ± 0.5	52.4 ± 1.5 26.0 ± 1.5	1.2 1.0	5	1 mm per 10 spacing, 0.5 mm per 5 spacing
MFR-25	MFR50S	6 ± 0.5	52.4 ± 1.5 26.0 ± 1.5	1.2 1.0	5	
MFR-50	MFR1WS	6 ± 0.5	52.4 ± 1.5	1.2	5	
MFR100	MFR2WS	6 ± 0.5	73.0 ± 1.5 52.4 ± 1.5	1.5 1.2	5	
MFR200	MFR3WS	6 ± 0.5	73.0 ± 1.5 52.4 ± 1.5	1.5 1.2	10	

TAPE ON REEL PACKING

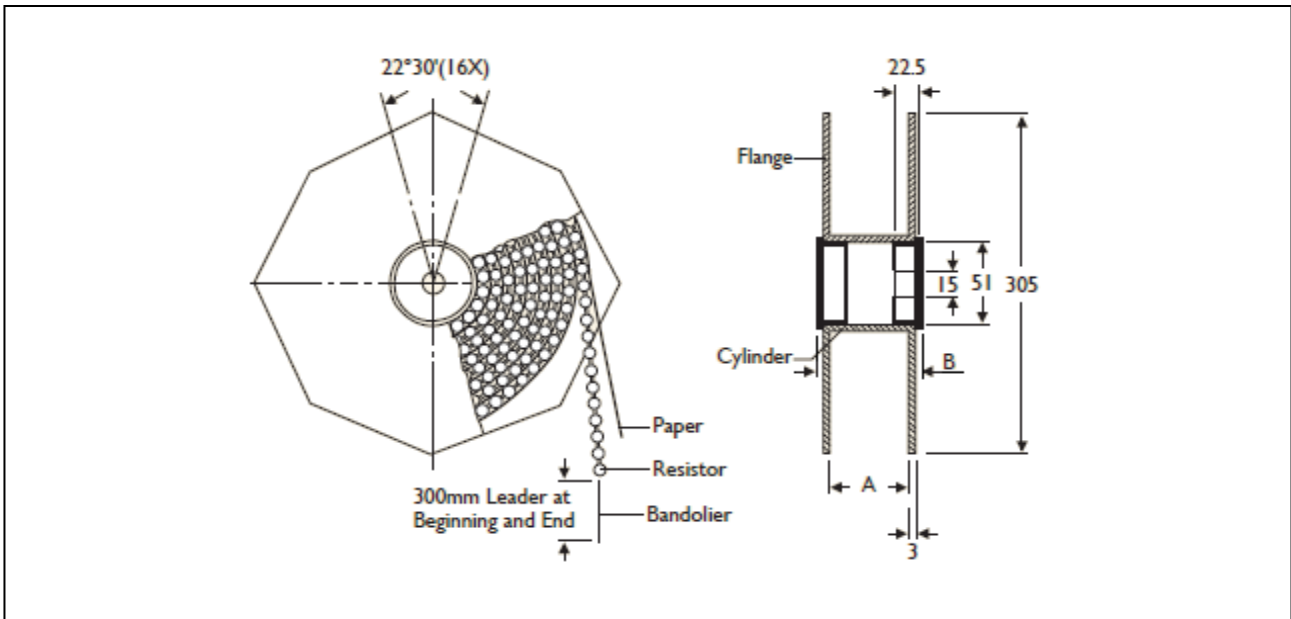

TYPE

Unit: mm/piece

Normal	Miniature	Across Flange(A)	B	Quantity Per Reel
MFR-12	MFR25S	66.5	75.5	5,000
MFR-25	MFR50S	66.5	75.5	5,000
MFR-50	MFR1WS	66.5	75.5	2,500
MFR100	MFR2WS	87	96	2,000
MFR200	MFR3WS	87	96	1,000

TAPE ON BOX PACKING

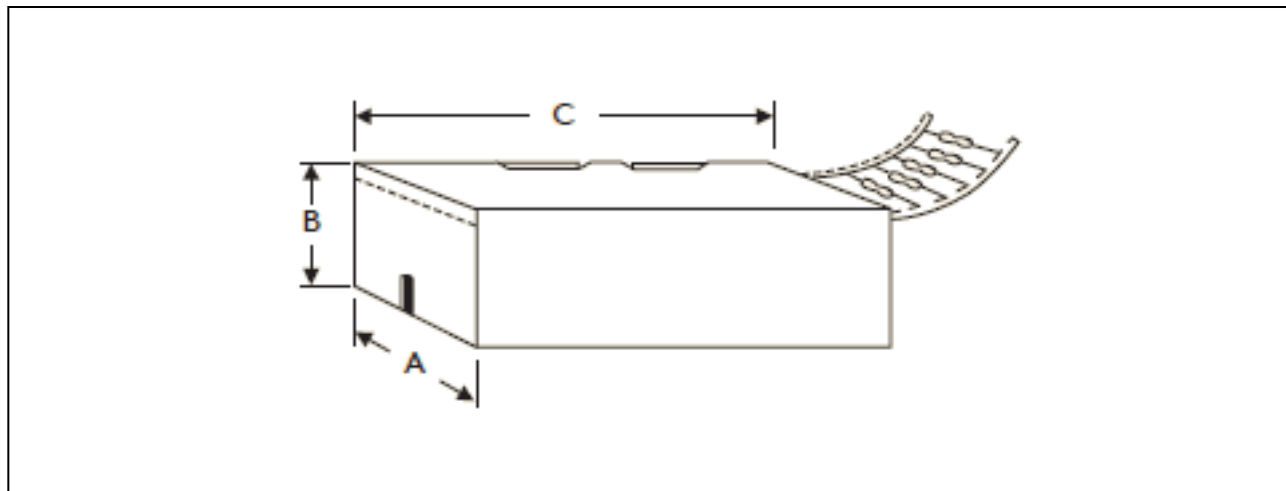

TYPE		DIMENSIONS			Unit: mm/piece
Normal	Miniature	A	B	C	Quantity Per Box
MFR-12	MFR25S	48	102	255	5,000
MFR-12	MFR25S	81	70	260	5,000
MFR-25	MFR50S	48	102	255	5,000
MFR-25	MFR50S	81	104	260	5,000
MFR-50	MFR1WS	73	45	258	1,000
MFR100	MFR2WS	81	91	260	1,000
MFR100	MFR2WS	103	78	260	1,000
MFR200	MFR3WS	81	91	260	1,000
MFR200	MFR3WS	103	94	260	1,000

BULK PACKING

Normal	Miniature	Piece/Per Inner Box	Bag/Per Inner Box	Piece Per Bag
MFR-12	MFR25S	10,000	10	1,000
MFR-25	MFR50S	10,000	10	1,000
MFR-50	MFR1WS	5,000	5	1,000
MFR100	MFR2WS	2,000	4	500
MFR200	MFR3WS	1,000	2	500

FORMING

M TYPE

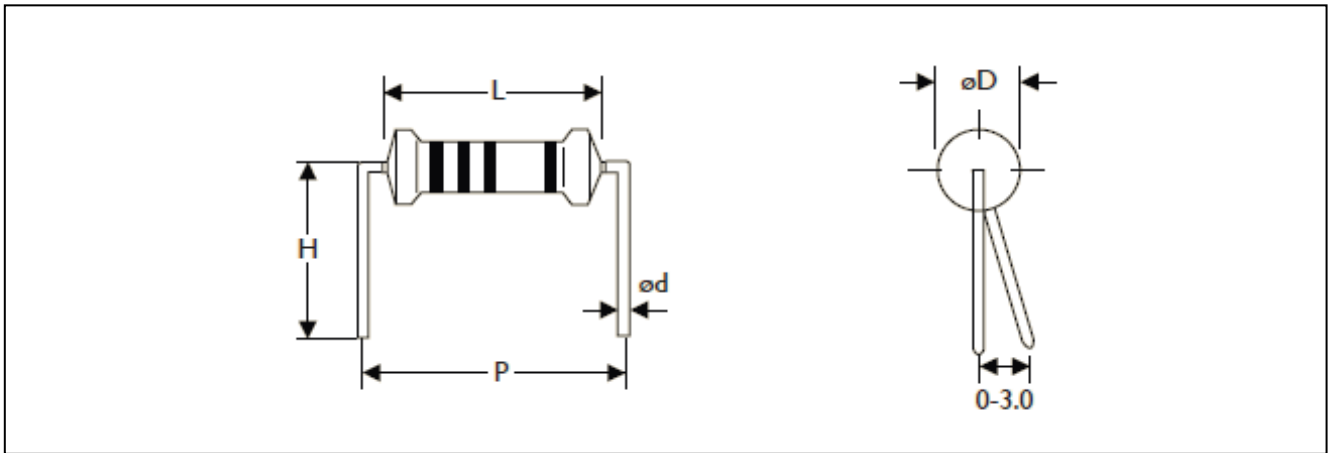

TYPE		DIMENSIONS					Unit: mm
Normal	Miniature	L	ψD	ψd	P	H	
MFR-12	MFR25S	3.4 ± 0.3	1.9 ± 0.2	0.45 ± 0.05	6.0 ± 1	10.0 ± 1	
MFR-25	MFR50S	6.3 ± 0.5	2.4 ± 0.2	0.55 ± 0.05	10.0 ± 1	10.0 ± 1	
MFR-50	MFR1WS	9.0 ± 0.5	3.3 ± 0.3	0.55 ± 0.05	12.5 ± 1	10.0 ± 1	
MFR100	MFR2WS	11.5 ± 1.0	4.5 ± 0.5	0.8 ± 0.05	15.0 ± 1	12.5 ± 1	
MFR200	MFR3WS	15.5 ± 1.0	5.0 ± 0.5	0.8 ± 0.05	20.0 ± 1	15.0 ± 1	

MB TYPE

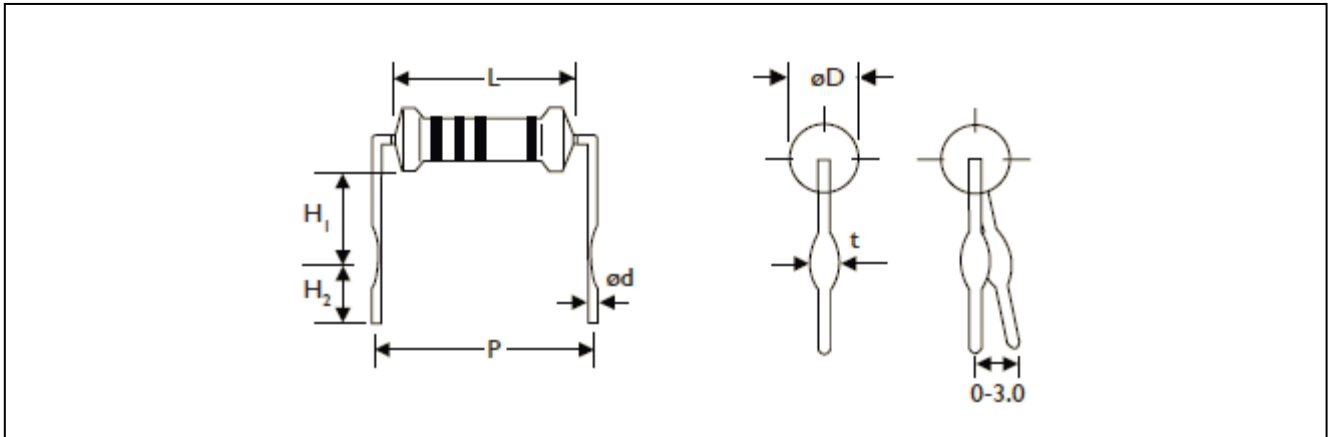

TYPE		DIMENSIONS							Unit: mm
Normal	Miniature	L	ψD	ψd	P	H1	H2	t	
MFR-25	MFR50S	6.3 ± 0.5	2.4 ± 0.2	0.55 ± 0.05	10.0 ± 1	6.0 ± 1	5.0 ± 1	1.2 ± 0.2	
MFR-50	-	9.0 ± 0.5	3.3 ± 0.3	0.55 ± 0.05	12.5 ± 1	6.0 ± 1	5.0 ± 1	1.2 ± 0.2	
-	MFR1WS	9.0 ± 0.5	3.3 ± 0.3	0.8 ± 0.05	12.5 ± 1	6.0 ± 1	5.0 ± 1	1.4 ± 0.2	
MFR100	MFR2WS	11.5 ± 1.0	4.5 ± 0.5	0.8 ± 0.05	15.0 ± 1	6.0 ± 1	5.0 ± 1	1.4 ± 0.2	
MFR200	MFR3WS	15.5 ± 1.0	5.0 ± 0.5	0.8 ± 0.05	20.0 ± 1	10.0 ± 1	5.0 ± 1	1.4 ± 0.2	

MHA TYPE

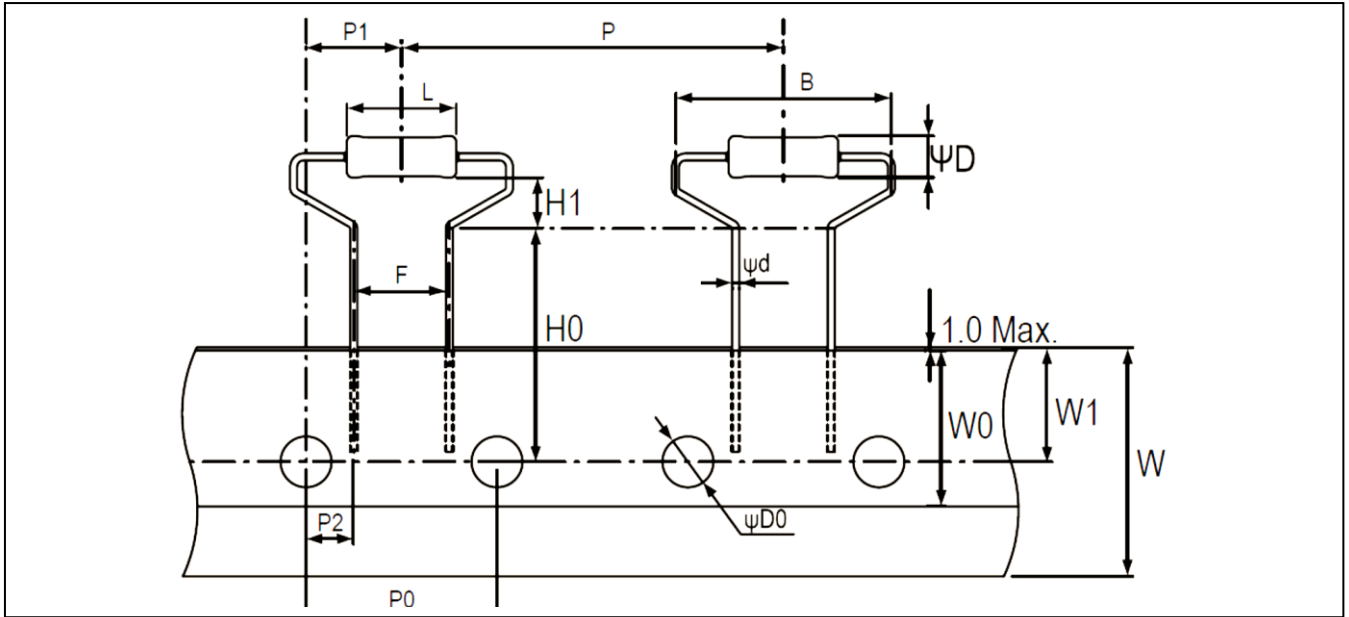

TYPE		DIMENSIONS								Unit: mm
Normal	Miniature	L	ψD	ψd	B	H0	H1	P	P0	
		9.0±0.5	3.3±0.3	0.55±0.05	17.5Max	19.0±1.0	4.0±1.0	30.0±1.0	15.0±0.3	
MFR-50	MFR1WS	P1	P2	F	W	W0	W1	$\psi D0$		
		7.5±1.0	3.75±0.5	7.5±0.5	18.0±0.5	5.0Min	9.0±0.5	4.0±0.2		

MHB TYPE

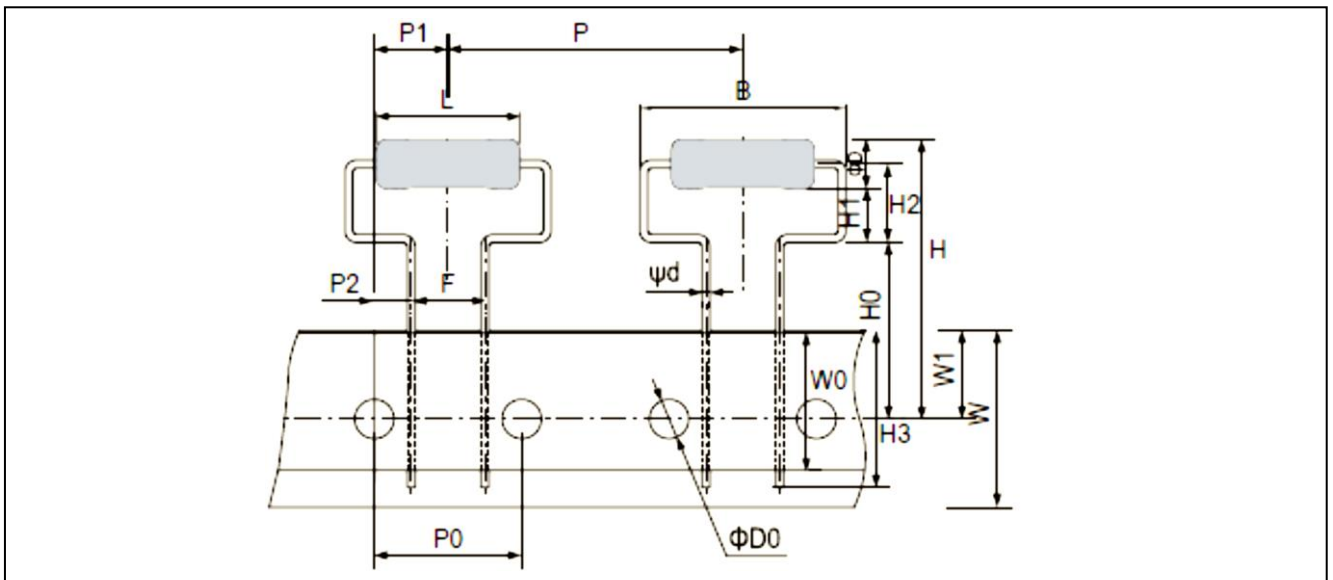

TYPE		DIMENSIONS									Unit: mm
Normal	Miniature	L	ψD	ψd	B	H	H0	H1	H2	H3	
		15.5±1.0	5.0±0.5	0.8±0.05	21.0Max.	30Max.	18.0±1.0	5.5(Ref.)	8.0±1.5	16Max.	
MFR200	MFR3WS	P	P0	P1	P2	F	W	W0	W1	$\psi D0$	
		30.0±1.0	15.0±0.3	7.5±1.0	3.75±0.8	7.5±0.5	18.0±0.5	5.0Min.	9.0±0.5	4.0±0.3	

MHC TYPE

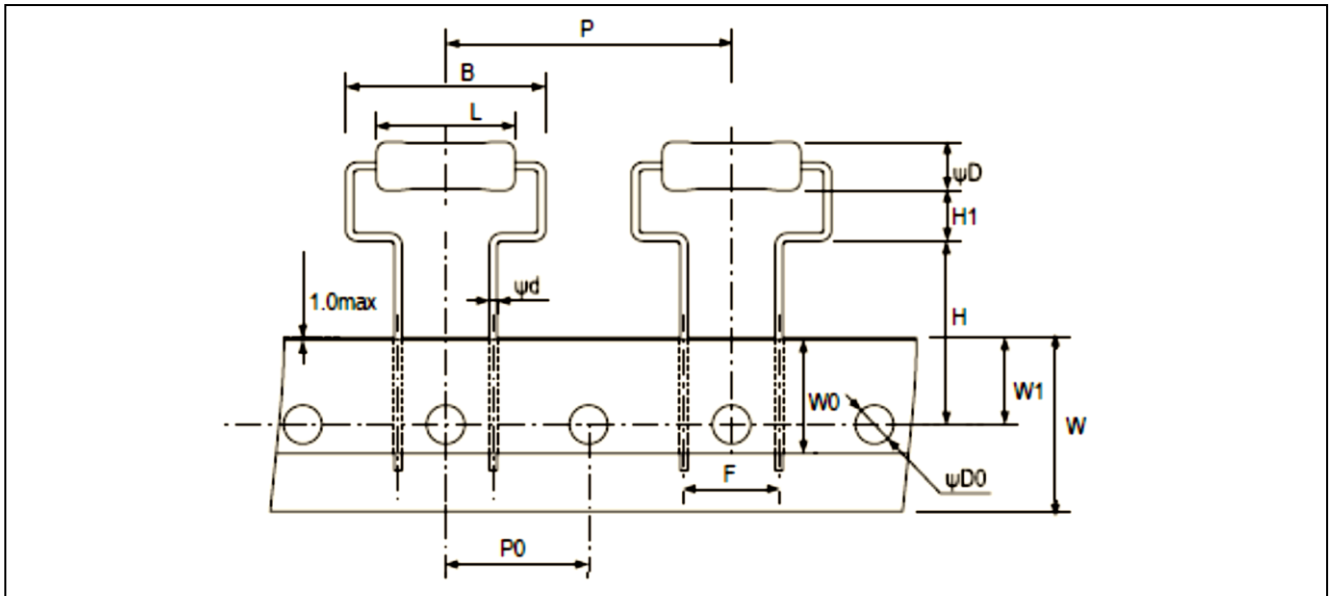

TYPE		DIMENSIONS								Unit: mm
Normal	Miniature	L	ψD	ψd	B	H	H1	P	P0	
		15.5±1.0	5.0±0.5	0.8±0.05	21.0Max.	19.0±1.0	5.25±1.0	30.0±1.0	15.0±0.3	
MFR200	MFR3WS	F	W	W0	W1	ψD0				
		10.0±0.5	18.0±0.5	5.0Min.	9.0±0.5	4.0±0.2				

F TYPE

FK TYPE

FFK TYPE

FKK TYPE

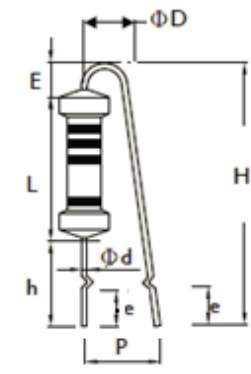
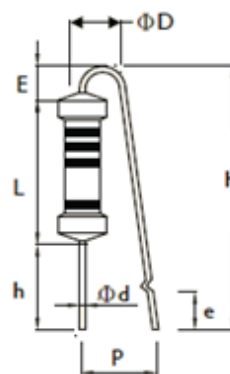
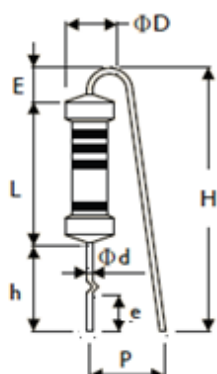
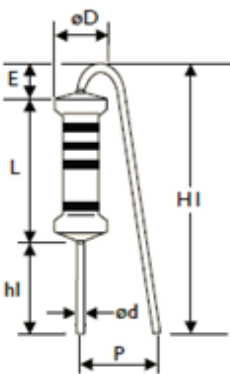

TYPE		DIMENSIONS										Unit: mm
Normal	Miniature	L	ψD	ψd	P	h	H Max.	h1	HI	E Max.	e	
MFR-50	MFR1WS	9.0±0.5	3.3±0.3	0.55±0.05	6±1	8±1	22	5±1	18.5 Max.	3.5	3.5±1	
MFR100	MFR2WS	11.5±1	4.5±0.5	0.8±0.05	6±1	8±1	24	5±1	20 Max.	3.5	3.5±1	
MFR200	MFR3WS	15.5±1	5.0±0.5	0.8±0.05	8±1	8±1	28	5±1	25 Max.	3.5	3.5±1	

FB- TYPE (for -25&50S)

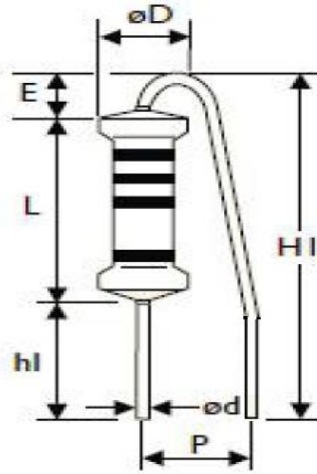

TYPE		DIMENSIONS						Unit: mm	
Normal	Miniature	L	ψD	ψd	P	hI	HI	E Max.	
MFR-25	MFR50S	6.3 ± 0.5	2.4 ± 0.2	0.55 ± 0.05	6 ± 1	5.5 ± 0.5	13.5 ± 0.5	3.5	

FT TYPE (Taping Pack)

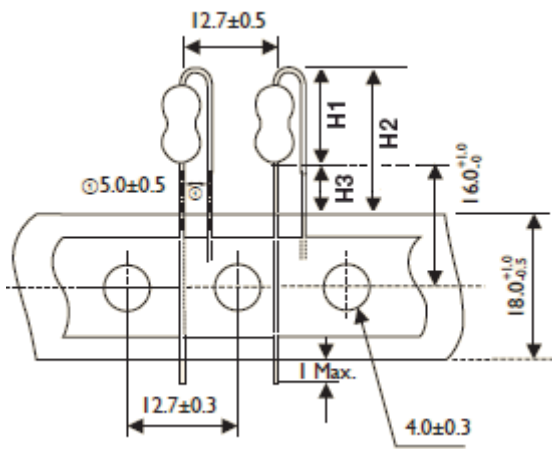

MT TYPE (Taping Pack)

Rated Watts : 1/6W,1/4WS

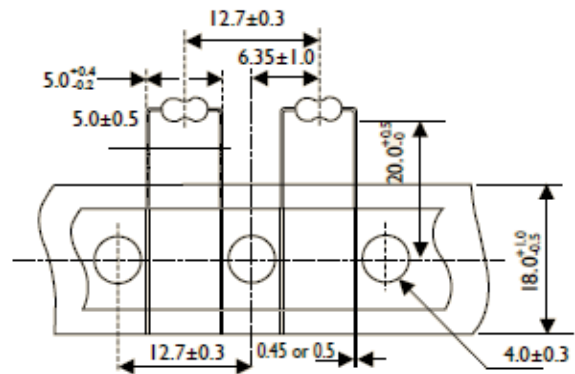

TYPE		DIMENSIONS			Unit: mm
Normal	Miniature	H1 Max.	H2 Max.	H3 Max.	
MFR-25	MFR50S	10	18.5	8.5	
MFR-50	MFR1WS	13	21.5	8.5	
MFR100	MFR2WS	16	24.5	8.5	

PN TYPE (Taping Pack)

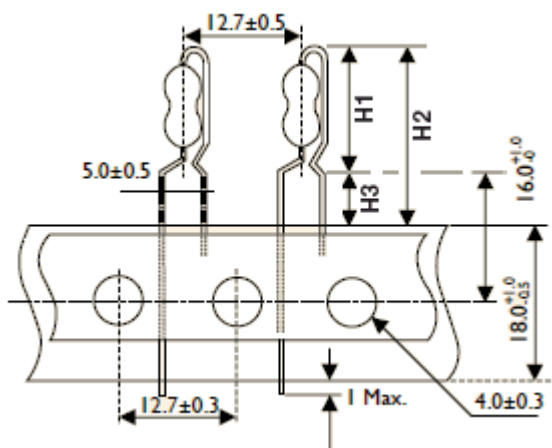

AV TYPE (Taping Pack)

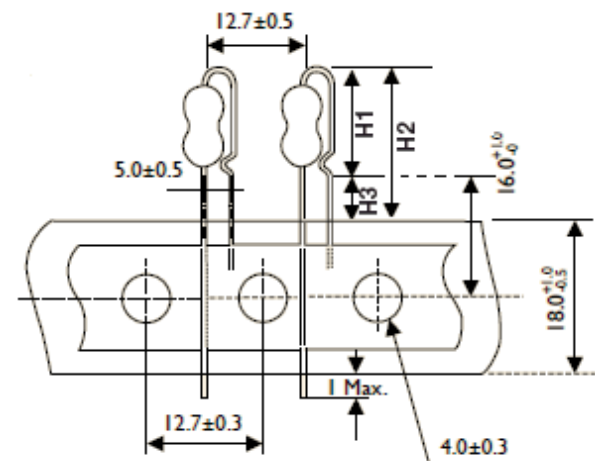

TYPE		DIMENSIONS			Unit: mm
Normal	Miniature	H1 Max.	H2 Max.	H3 Max.	
MFR-25	MFR50S	13	21.5	8.5	
MFR-50	MFR1WS	17	25.5	8.5	
MFR100	MFR2WS	19	27.5	8.5	

TYPE		DIMENSIONS			Unit: mm
Normal	Miniature	H1 Max.	H2 Max.	H3 Max.	
MFR-25	MFR50S	11.5	20	8.5	
MFR-50	MFR1WS	14.5	23	8.5	
MFR100	MFR2WS	17.5	26	8.5	

MARKING

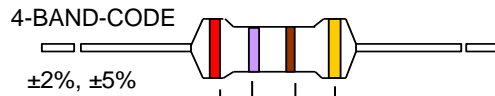

COLOR	1st BAND	2nd BAND	3rd BAND	MULTIPLIER	TOLERANCE
BLACK	0	0	0	1Ω	
BROWN	1	1	1	10Ω	± 1% (F)
RED	2	2	2	100Ω	± 2% (G)
ORANGE	3	3	3	1KΩ	
YELLOW	4	4	4	10KΩ	
GREEN	5	5	5	100K	± 0.5 % (D)
BLUE	6	6	6	1MΩ	
VIOLET	7	7	7	10MΩ	
GREY	8	8	8	0.001Ω	
WHITE	9	9	9	0.0001Ω	
GOLD				0.1Ω	± 5 % (J)
SILVER				0.01Ω	



REVISION HISTORY

REVISION	DATE	CHANGE NOTIFICATION	DESCRIPTION
Version 4	Apr.2, 2024	-	- Added forming code description for part number
Version 3	Sep.6, 2023	-	- Updated legal disclaimer and footer versions numbers
Version 2	Aug.31, 2022	-	- Add FB- forming code to -25&50S - Will EOL F forming code to -25&50S on Feb.28,2023
Version 1	Sep.28, 2021	-	- Add F TYPE for -25&50S power
Version 0	Aug.2, 2021	-	- First issue of this specification

“ Yageo reserves all the rights for revising the content of this datasheet without further notification, as long as the products itse lf are unchanged. Any product change will be announced by PCN.”

LEGAL DISCLAIMER

YAGEO, its distributors and agents (collectively, "YAGEO"), hereby disclaims any and all liabilities for any errors, inaccuracies or incompleteness contained in any product related information, including but not limited to product specifications, datasheets, pictures and/or graphics. YAGEO may make changes, modifications and/or improvements to product related information at any time and without notice.

YAGEO makes no representation, warranty, and/or guarantee about the fitness of its products for any particular purpose or the continuing production of any of its products. To the maximum extent permitted by law, YAGEO disclaims (i) any and all liability arising out of the application or use of any YAGEO product, (ii) any and all liability, including without limitation special, consequential or incidental damages, and (iii) any and all implied warranties, including warranties of fitness for a particular purpose, non-infringement and merchantability.

YAGEO products are designed for general purpose applications under normal operation and usage conditions. Please contact YAGEO for the applications listed below which require especially high reliability for the prevention of defects which might directly cause damage to the third party's life, body or property: Aerospace equipment (artificial satellite, rocket, etc.), Atomic energy-related equipment, Aviation equipment, Disaster prevention equipment, crime prevention equipment, Electric heating apparatus, burning equipment, Highly public information network equipment, data-processing equipment, Medical devices, Military equipment, Power generation control equipment, Safety equipment, Traffic signal equipment, Transportation equipment and Undersea equipment, or for any other application or use in which the failure of YAGEO products could result in personal injury or death, or serious property damage. Particularly **YAGEO Corporation and its affiliates do not recommend the use of commercial or automotive grade products for high reliability applications or manned space flight.**

Information provided here is intended to indicate product specifications only. YAGEO reserves all the rights for revising this content without further notification, as long as products are unchanged. Any product change will be announced by PCN.

Mouser Electronics

Authorized Distributor

Click to View Pricing, Inventory, Delivery & Lifecycle Information:

[YAGEO:](#)

[MFR100FTE52-24R9](#)