

## VDR Metal Oxide Varistors Standard

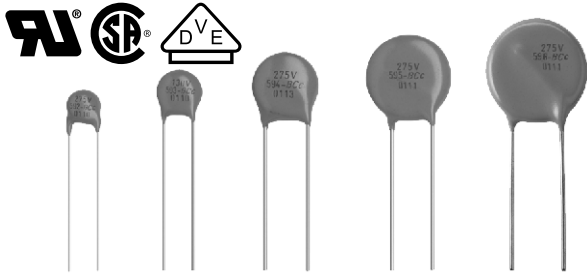

### FEATURES

- Zinc oxide disc, epoxy coated
- Straight leads
- Straight leads with flange (2381 592 and 593 series only)
- Kinked leads
- Compliant to RoHS directive 2002/95/EC and in accordance to WEEE 2002/96/EC
- Certified according to UL 1449 edition 3, VDE/IEC 61051-1/2 and CSA



**RoHS**  
COMPLIANT

### APPLICATION

- Overvoltage and transient voltage protection

### DESCRIPTION

The varistors consist of a disc of low-β ceramic material with two tinned solid copper leads or tinned copper clad steel wire. They are coated with a layer of ochre coloured epoxy, which provides electrical, mechanical and climatic protection. The encapsulation is resistant to all cleaning solvents in accordance with IEC 60068-2-45.

### MOUNTING

The varistors are suitable for processing on automatic insertion and cutting and bending equipment.

Varistors with flanged leads provide better positioning on printed-circuit boards (PCB) and more accurate control over component height. This is important for hand mounting and automatic insertion techniques; see outlines of flanged leads drawing.

### Typical soldering

235 °C, duration: 5 s (Pb-bearing)

245 °C, duration: 5 s (lead (Pb)-free)

### Resistance to soldering heat

260 °C, duration: 10 s max.

### MARKING

The varistors are marked with the following information:

- Maximum continuous RMS voltage
- Series number (592, 593, 594, 595 or 596)
- Manufacturers logo
- Date of manufacture (YYWW)

### INFLAMMABILITY

The varistors are non-flammable.

The encapsulation is made of flammable resistant epoxy in accordance with UL 94 V-0.

QUICK REFERENCE DATA		
PARAMETER	VALUE	UNIT
Maximum continuous voltage in operating temperature range:		
RMS	14 to 680	V
DC	18 to 895	V
Maximum non-repetitive transient current $I_{NRP}$ (8 x 20 μs)	100 to 6500	A
Detailed specification	Based on IEC 61051-1 IEC 61051-2 IEC 61051-2-2	
Storage temperature	- 40 to + 125	°C
Operating temperature	- 40 to + 85	°C

### ORDERING INFORMATION

The varistors are available in a number of packaging options:

- Bulk
- On tape on reel
- On tape in ammpack

The basic ordering code for each option is given in tables titled Varistors on Tape on Reel, Varistors on Tape in Ammpack and Varistors in Bulk. To complete the catalog number and to determine the required operating parameters, see Electrical Data and Ordering Information table.

ELECTRICAL DATA AND ORDERING INFORMATION												
MAXIMUM CONTINUOUS VOLTAGE		VOLTAGE <sup>(3)</sup> at 1 mA	MAXIMUM VOLTAGE at STATED CURRENT		MAXIMUM ENERGY <sup>(4)</sup> (10 x 1000 μs)	MAXIMUM NON-REP. TRANSIENT CURRENT <sup>(5)</sup> $I_{NRP}$ (8 x 20 μs)	TYPICAL CAP. at 1 kHz	T (max.)	E	UL 1449 ED3 SPD TYPE <sup>(8)</sup>	CATALOG NUMBERS <sup>(1)</sup>	
RMS <sup>(2)</sup> (V)	DC (V)	(V)	V (V)	I (A)	(J)	(A)	(pF)	(mm)	(mm)		SAP <sup>(7)</sup>	12NC <sup>(6)</sup> 2381-
14	18	22	48	1.0	0.5	100	1300	4.1	0.7 ± 0.3	4	VDRS05A014xyE	592 x140y
			43	2.5	1.7	250	2800	4.1	0.7 ± 0.3	4	VDRS07B014xyE	593 x140y
			43	5.0	4.3	500	6000	4.4	0.9 ± 0.3	4	VDRS10D014xyE	594 x140y
			43	10.0	5.4	1000	15 000	4.4	0.9 ± 0.3	4	VDRS14G014xyE	595 x140y
			43	20.0	8.0	2000	30 000	4.6	1.1 ± 0.3	4	VDRS20M014ByE	596 x140y



**ELECTRICAL DATA AND ORDERING INFORMATION**

MAXIMUM CONTINUOUS VOLTAGE		VOLTAGE <sup>(3)</sup> at 1 mA	MAXIMUM VOLTAGE at STATED CURRENT		MAXIMUM ENERGY <sup>(4)</sup> (10 x 1000 µs)	MAXIMUM NON-REP. TRANSIENT CURRENT <sup>(5)</sup> I <sub>NRP</sub> (8 x 20 µs)	TYPICAL CAP. at 1 kHz	T (max.)	E	UL 1449 ED3 SPD TYPE <sup>(8)</sup>	CATALOG NUMBERS <sup>(1)</sup>	
RMS <sup>(2)</sup> (V)	DC (V)	(V)	V (V)	I (A)	(J)	(A)	(pF)	(mm)	(mm)		SAP <sup>(7)</sup>	12NC <sup>(6)</sup> 2381-
17	22	27	60	1.0	0.7	100	1050	4.1	0.8 ± 0.3	4	VDRS05A017xyE	592 x170y
			53	2.5	2.0	250	2000	4.1	0.8 ± 0.3	4	VDRS07B017xyE	593 x170y
			53	5.0	5.3	500	4000	4.4	1.0 ± 0.3	4	VDRS10D017xyE	594 x170y
			53	10.0	6.9	1000	10 000	4.4	1.0 ± 0.3	4	VDRS14G017xyE	595 x170y
			53	20.0	10.0	2000	20 000	4.6	1.2 ± 0.3	4	VDRS20M017ByE	596 x170y
20	26	33	73	1.0	0.8	100	900	4.1	1.0 ± 0.3	4	VDRS05A020xyE	592 x200y
			65	2.5	2.5	250	1500	4.1	1.0 ± 0.3	4	VDRS07B020xyE	593 x200y
			65	5.0	6.5	500	3000	4.4	1.2 ± 0.3	4	VDRS10D020xyE	594 x200y
			65	10.0	8.8	1000	7500	4.4	1.2 ± 0.3	4	VDRS14G020xyE	595 x200y
			65	20.0	12.0	2000	15 000	4.8	1.4 ± 0.3	4	VDRS20M020ByE	596 x200y
25	31	39	86	1.0	0.9	100	500	4.2	1.2 ± 0.3	4	VDRS05A025xyE	592 x250y
			77	2.5	3.0	250	1350	4.2	1.2 ± 0.3	4	VDRS07B025xyE	593 x250y
			77	5.0	7.7	500	2600	4.6	1.4 ± 0.3	4	VDRS10D025xyE	594 x250y
			77	10.0	9.4	1000	6500	4.6	1.4 ± 0.3	4	VDRS14G025xyE	595 x250y
			77	20.0	14.0	2000	13 000	5.0	1.6 ± 0.3	4	VDRS20M025ByE	596 x250y
30	38	47	96	1.0	1.1	100	700	4.4	1.4 ± 0.5	4	VDRS05A030xyE	592 x300y
			93	2.5	3.6	250	1600	4.4	1.4 ± 0.5	4	VDRS07B030xyE	593 x300y
			93	5.0	9.2	500	2700	4.8	1.6 ± 0.5	4	VDRS10D030xyE	594 x300y
			90	10.0	12.0	1000	6000	4.8	1.6 ± 0.5	4	VDRS14G030xyE	595 x300y
			93	20.0	17.0	2000	12 000	5.2	1.8 ± 0.5	4	VDRS20M030ByE	596 x300y
35	45	56	123	1.0	1.4	100	560	4.8	1.7 ± 0.5	4	VDRS05A035xyE	592 x350y
			115	2.5	4.4	250	1300	4.8	1.7 ± 0.5	4	VDRS07B035xyE	593 x350y
			110	5.0	11.0	500	2200	5.2	1.9 ± 0.5	4	VDRS10D035xyE	594 x350y
			105	10.0	14.0	1000	4800	5.2	1.9 ± 0.5	4	VDRS14G035xyE	595 x350y
			110	20.0	20.0	2000	9600	5.6	2.1 ± 0.5	4	VDRS20M035ByE	596 x350y
40	56	68	145	1.0	1.6	100	460	5.1	2.1 ± 0.5	4	VDRS05A040xyE	592 x400y
			135	2.5	5.2	250	1000	5.1	2.1 ± 0.5	4	VDRS07B040xyE	593 x400y
			130	5.0	13.0	500	1800	5.5	2.3 ± 0.5	4	VDRS10D040xyE	594 x400y
			130	10.0	17.0	1000	3800	5.5	2.3 ± 0.5	4	VDRS14G040xyE	595 x400y
			135	20.0	24.0	2000	7600	5.9	2.5 ± 0.5	4	VDRS20M040ByE	596 x400y
50	65	82	145	5.0	2.6	400	370	4.1	0.6 ± 0.3	4	VDRS05C050xyE	592 x500y
			140	10.0	7.0	1200	900	4.1	0.6 ± 0.3	4	VDRS07H050xyE	593 x500y
			140	25.0	12.0	2500	1500	4.4	0.8 ± 0.3	4	VDRS10P050xyE	594 x500y
			140	50.0	21.0	4500	3100	4.4	0.8 ± 0.3	4	VDRS14T050xyE	595 x500y
60	85	100	165	5.0	2.9	400	290	4.1	0.7 ± 0.3	4	VDRS05C060xyE	592 x600y
			165	10.0	8.3	1200	700	4.1	0.7 ± 0.3	4	VDRS07H060xyE	593 x600y
			165	25.0	15.0	2500	1200	4.4	0.9 ± 0.3	4	VDRS10P060xyE	594 x600y
			165	50.0	24.0	4500	2300	4.4	0.9 ± 0.3	3	VDRS14T060xyE	595 x600y
			165	100.0	56.0	6500	4700	4.5	1.1 ± 0.3	2	VDRS20W060ByE	596 x600y
75	100	120	190	5.0	3.4	400	240	4.1	0.9 ± 0.3	4	VDRS05C075xyE	592 x750y
			200	10.0	10.0	1200	530	4.1	0.9 ± 0.3	4	VDRS07H075xyE	593 x750y
			200	25.0	18.0	2500	1000	4.4	1.1 ± 0.3	4	VDRS10P075xyE	594 x750y
			200	50.0	29.0	4500	1900	4.4	1.1 ± 0.3	3	VDRS14T075xyE	595 x750y
			200	100.0	64.0	6500	3900	4.8	1.3 ± 0.3	2	VDRS20W075ByE	596 x750y
95	125	150	230	5.0	4.1	400	180	4.2	1.1 ± 0.3	4	VDRS05C095xyE	592 x950y
			250	10.0	13.0	1200	450	4.2	1.1 ± 0.3	4	VDRS07H095xyE	593 x950y
			250	25.0	22.0	2500	800	4.6	1.3 ± 0.3	4	VDRS10P095xyE	594 x950y
			250	50.0	37.0	4500	1500	4.6	1.3 ± 0.3	3	VDRS14T095xyE	595 x950y
			250	100.0	88.0	6500	3000	5.2	1.5 ± 0.3	2	VDRS20W095ByE	596 x950y



ELECTRICAL DATA AND ORDERING INFORMATION												
MAXIMUM CONTINUOUS VOLTAGE		VOLTAGE <sup>(3)</sup> at 1 mA	MAXIMUM VOLTAGE at STATED CURRENT		MAXIMUM ENERGY <sup>(4)</sup> (10 x 1000 µs)	MAXIMUM NON-REP. TRANSIENT CURRENT <sup>(5)</sup> I <sub>NRP</sub> (8 x 20 µs)	TYPICAL CAP. at 1 kHz	T (max.)	E	UL 1449 ED3 SPD TYPE <sup>(8)</sup>	CATALOG NUMBERS <sup>(1)</sup>	
RMS <sup>(2)</sup> (V)	DC (V)	(V)	V (V)	I (A)	(J)	(A)	(pF)	(mm)	(mm)		SAP <sup>(7)</sup>	12NC <sup>(6)</sup> 2381-
130	170	205	310	5.0	5.5	400	130	4.2	1.0 ± 0.3	4	VDRS05C130xyE	592 x131y
			340	10.0	17.0	1200	320	4.2	1.0 ± 0.3	4	VDRS07H130xyE	593 x131y
			340	25.0	30.0	2500	580	4.6	1.2 ± 0.3	4	VDRS10P130xyE	594 x131y
			340	50.0	56.0	4500	1050	4.6	1.2 ± 0.3	3	VDRS14T130xyE	595 x131y
			340	100.0	114.0	6500	2100	5.3	1.4 ± 0.3	2	VDRS20W130ByE	596 x131y
140	180	220	350	5.0	6.3	400	120	4.4	1.0 ± 0.3	4	VDRS05C140xyE	592 x141y
			370	10.0	21.0	1200	290	4.4	1.0 ± 0.3	4	VDRS07H140xyE	593 x141y
			370	25.0	33.0	2500	540	4.8	1.2 ± 0.3	4	VDRS10P140xyE	594 x141y
			370	50.0	57.0	4500	950	4.8	1.2 ± 0.3	3	VDRS14T140xyE	595 x141y
			360	100.0	124.0	6500	1900	5.4	1.5 ± 0.3	2	VDRS20W140ByE	596 x141y
150	200	240	395	5.0	7.1	400	110	4.4	1.1 ± 0.3	4	VDRS05C150xyE	592 x151y
			400	10.0	20.0	1200	270	4.4	1.1 ± 0.3	4	VDRS07H150xyE	593 x151y
			400	25.0	36.0	2500	490	4.8	1.3 ± 0.3	4	VDRS10P150xyE	594 x151y
			400	50.0	59.0	4500	850	4.8	1.3 ± 0.3	3	VDRS14T150xyE	595 x151y
			395	100.0	134.0	6500	1700	5.5	1.6 ± 0.3	2	VDRS20W150ByE	596 x151y
175	225	275	410	5.0	7.3	400	90	4.6	1.3 ± 0.3	4	VDRS05C175xyE	592 x171y
			455	10.0	23.0	1200	230	4.6	1.3 ± 0.3	4	VDRS07H175xyE	593 x171y
			455	25.0	41.0	2500	430	5.0	1.5 ± 0.3	4	VDRS10P175xyE	594 x171y
			455	50.0	67.0	4500	750	5.0	1.5 ± 0.3	3	VDRS14T175xyE	595 x171y
			455	100.0	158.0	6500	1500	5.7	1.7 ± 0.3	2	VDRS20W175ByE	596 x171y
230	300	360	560	5.0	10.0	400	70	4.9	1.7 ± 0.8	4	VDRS05C230xyE	592 x231y
			600	10.0	30.0	1200	170	4.9	1.7 ± 0.8	4	VDRS07H230xyE	593 x231y
			600	25.0	54.0	2500	320	5.4	1.9 ± 0.8	4	VDRS10P230xyE	594 x231y
			600	50.0	88.0	4500	540	5.4	1.9 ± 0.8	3	VDRS14T230xyE	595 x231y
			595	100.0	208.0	6500	1100	6.2	2.2 ± 0.8	2	VDRS20W230ByE	596 x231y
250	320	390	600	5.0	11.0	400	60	4.9	1.9 ± 0.8	4	VDRS05C250xyE	592 x251y
			650	10.0	33.0	1200	160	4.9	1.9 ± 0.8	4	VDRS07H250xyE	593 x251y
			650	25.0	58.0	2500	300	5.4	2.1 ± 0.8	4	VDRS10P250xyE	594 x251y
			650	50.0	96.0	4500	480	5.4	2.1 ± 0.8	3	VDRS14T250xyE	595 x251y
			650	100.0	240.0	6500	960	6.4	2.3 ± 0.8	2	VDRS20W250ByE	596 x251y
275	350	430	695	5.0	12.0	400	55	4.9	2.0 ± 0.8	4	VDRS05C275xyE	592 x271y
			710	10.0	36.0	1200	140	4.9	2.0 ± 0.8	4	VDRS07H275xyE	593 x271y
			710	25.0	63.0	2500	270	5.4	2.2 ± 0.8	4	VDRS10P275xyE	594 x271y
			710	50.0	104.0	4500	440	5.4	2.2 ± 0.8	3	VDRS14T275xyE	595 x271y
			710	100.0	264.0	6500	900	6.6	2.5 ± 0.8	2	VDRS20W275ByE	596 x271y
300	385	470	750	5.0	13.0	400	50	5.3	2.2 ± 0.8	4	VDRS05C300xyE	592 x301y
			800	10.0	40.0	1200	130	5.3	2.2 ± 0.8	4	VDRS07H300xyE	593 x301y
			800	25.0	71.0	2500	240	5.9	2.4 ± 0.8	4	VDRS10P300xyE	594 x301y
			800	50.0	117.0	4500	400	5.9	2.4 ± 0.8	3	VDRS14T300xyE	595 x301y
			775	100.0	280.0	6500	810	6.9	2.7 ± 0.8	2	VDRS20W300ByE	596 x301y
320	420	510	800	5.0	15.0	400	45	5.5	2.4 ± 0.8	4	VDRS05C320xyE	592 x321y
			850	10.0	44.0	1200	120	5.5	2.4 ± 0.8	4	VDRS07H320xyE	593 x321y
			850	25.0	77.0	2500	220	6.2	2.6 ± 0.8	4	VDRS10P320xyE	594 x321y
			850	50.0	120.0	4500	370	6.2	2.6 ± 0.8	3	VDRS14T320xyE	595 x321y
			842	100.0	296.0	6500	750	7.1	2.9 ± 0.8	2	VDRS20W320ByE	596 x321y
350	460	560	940	5.0	19.5	400	42	5.8	2.7 ± 0.8	4	VDRS05C350xyE	592 x351y
			920	10.0	39.0	1200	110	5.8	2.7 ± 0.8	4	VDRS07H350xyE	593 x351y
			920	25.0	78.0	2500	200	6.6	2.9 ± 0.8	4	VDRS10P350xyE	594 x351y
			920	50.0	156.0	4500	325	6.6	2.9 ± 0.8	3	VDRS14T350xyE	595 x351y
			920	100.0	312.0	6500	660	7.4	3.2 ± 0.8	2	VDRS20W350ByE	596 x351y



**ELECTRICAL CHARACTERISTICS**

ELECTRICAL DATA		
PARAMETER	VALUE	UNIT
Maximum continuous voltage:		
RMS	14 to 680	V
DC	18 to 895	V
Maximum non-repetitive transient current ( $I_{NRP}$ ) (8 x 20 $\mu$ s):		
VDRS05.....E/2381 592 ....	100 or 400	A
VDRS07.....E/2381 593 ....	250 or 1200	A
VDRS10.....E/2381 594 ....	500 or 2500	A
VDRS14.....E/2381 595 ....	1000 or 4500	A
VDRS20.....E/2381 596 ....	2000 or 6500	A
Thermal resistance:		
VDRS05.....E/2381 592 ....	$\approx$ 80	K/W
VDRS07.....E/2381 593 ....	$\approx$ 70	K/W
VDRS10.....E/2381 594 ....	$\approx$ 60	K/W
VDRS14.....E/2381 595 ....	$\approx$ 50	K/W
VDRS20.....E/2381 596 ....	$\approx$ 40	K/W
Maximum dissipation:		
VDRS05.....E/2381 592 ....	100	mW
VDRS07.....E/2381 593 ....	250	mW
VDRS10.....E/2381 594 ....	400	mW
VDRS14.....E/2381 595 ....	600	mW
VDRS20.....E/2381 596 ....	1000	mW
Temperature coefficient of voltage at 1 mA maximum	$\pm$ 0.05	%/K
Voltage proof between interconnected leads and case	2500	V
Storage temperature	- 40 to + 125	$^{\circ}$ C
Operating temperature	- 40 to + 85	$^{\circ}$ C

**DERATING CURVE**

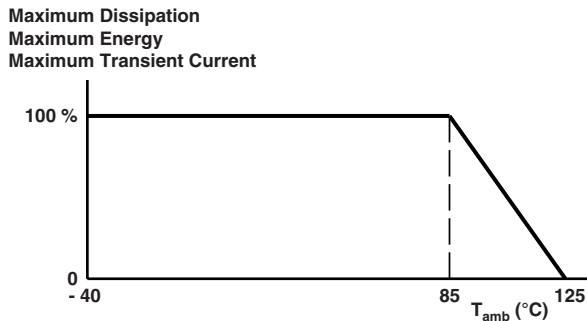

**PEAK CURRENT AS A FUNCTION OF PULSE WIDTH**

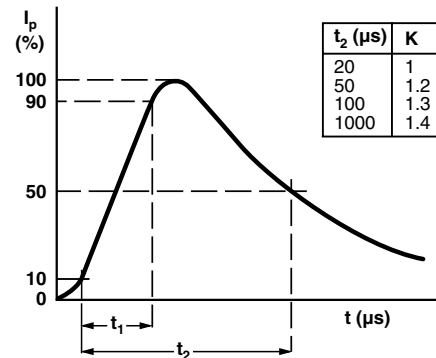

**COMPONENT DIMENSIONS (BULK TYPE) in millimeters AND CATALOG NUMBERS**

D MAX.	A MAX.	A <sub>0</sub> MAX.	L MIN.	T <sup>(1)</sup> MAX.	E <sup>(1)</sup>	d	F	CATALOG NUMBER
7.0	9.0	11.0	24.0	6.5	0.7 to 3.6	0.6 $\pm$ 0.05	5 $\pm$ 1.0	VDRS05.....E/2381 592 ....
9.0	11.0	13.0	24.0	6.5	0.7 to 3.6	0.6 $\pm$ 0.05	5 $\pm$ 1.0	VDRS07.....E/2381 593 ....
13.5	15.5	18.0	17.0	8	0.9 to 4.5	0.8 $\pm$ 0.05	7.5 $\pm$ 1.0	VDRS10.....E/2381 594 ....
17.0	19.0	23.0	16.0	8	0.9 to 4.5	0.8 $\pm$ 0.05	7.5 $\pm$ 1.0	VDRS14.....E/2381 595 ....
23.0	25.0	28.0	24.0	10	1.1 to 5.8	1.0 $\pm$ 0.05	10 $\pm$ 1.0	VDRS20.....E/2381 596 ....

**Note**

<sup>(1)</sup>  $T_{max}$ . and E values per size and voltage level can be found back in the Electrical Data table

<b>VARISTORS IN BULK</b>					
<b>TYPE</b>	<b>VDRS05... 2381 592 ... Ø 5 mm 14 V to 460 V</b>	<b>VDRS07... 2381 593 ..... Ø 7 mm 14 V to 460 V</b>	<b>VDRS10... 2381 594 ..... Ø 10 mm 14 V to 550 V</b>	<b>VDRS14... 2381 595 ..... Ø 14 mm 14 V to 550 V</b>	<b>VDRS20... 2381 596 ..... Ø 20 mm 14 V to 680 V</b>
Straight leads; see outline of components with straight leads drawing <sup>(1)</sup>	BSE 5...6	BSE 5...6	BSE 5...6	BSE 5...6	BSE 5...6
Straight leads with flange; see outline of components with flanged leads drawing	BFE 7...6	BFE 7...6	-	-	-
Kinked leads; see outline of components with kinked leads drawing	BKE 6...6	BKE 6...6	BKE 6...6	BKE 6...6	BKE 6...6
<b>Packaging quantities</b>					
14 V to 95 V	250	250	250	100	50
130 V to 385 V	250	250	250	100	50
420 V to 460 V	250	250	200	100	50
485 V to max. V	-	250	150	100	50

**Note**
<sup>(1)</sup> Outline of the Ø 20 mm differs from the other dimensions

**DIMENSIONS** in millimeters: See Component Dimensions and Electrical Data table

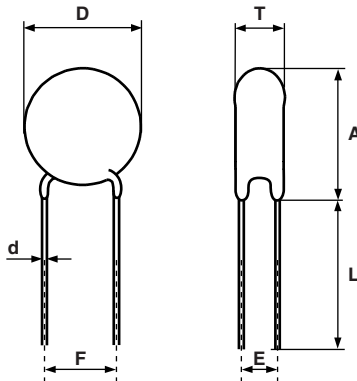
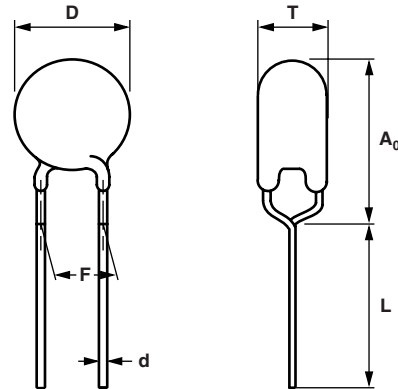
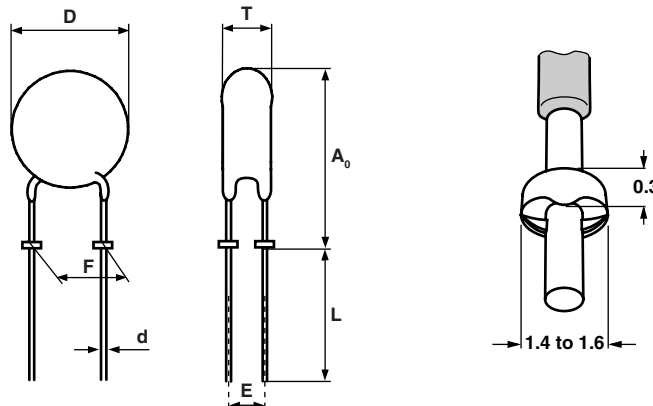
**OUTLINE** of Component with Straight Leads

**OUTLINE** of Component with Kinked Leads

**OUTLINE** of Component with Flanged Leads

<b>VARISTORS ON TAPE IN AMMOPACK</b>				
TYPE	VDRS05... 2381 592 ... Ø 5 mm 14 V to 460 V	VDRS07... 2381 593 ... Ø 7 mm 14 V to 460 V	VDRS10... 2381 594 ... Ø 10 mm 14 V to 550 V	VDRS14... 2381 595 ... Ø 14 mm 14 V to 550 V
Straight leads				
H = 18 mm	-	-	ASE 0...7	ASE 0...7
H = 20 mm	ASE 0...7	ASE 0...7	-	-
See drawing: Taped version with straight leads				
Straight leads with flange				
H <sub>0</sub> = 16 mm	AGE 1...7	AGE 1...7	-	-
H <sub>0</sub> = 18.25 mm	AHE 2...7	AHE 2...7	-	-
See drawing: Taped version with flanged leads				
Kinked leads				
H <sub>0</sub> = 18.25 mm	AME 3...7	AME 3...7	AME 3...7	AME 3...7
H <sub>0</sub> = 16 mm	ALE 8...7	ALE 8...7	ALE 8...7	ALE 8...7
See drawing: Taped version with kinked leads				
<b>Packaging quantities</b>				
14 V to 210 V	1500 <sup>(1)</sup>	1500 <sup>(1)</sup>	500	500
230 V to max. V	1000	1000	500	500

**Note**

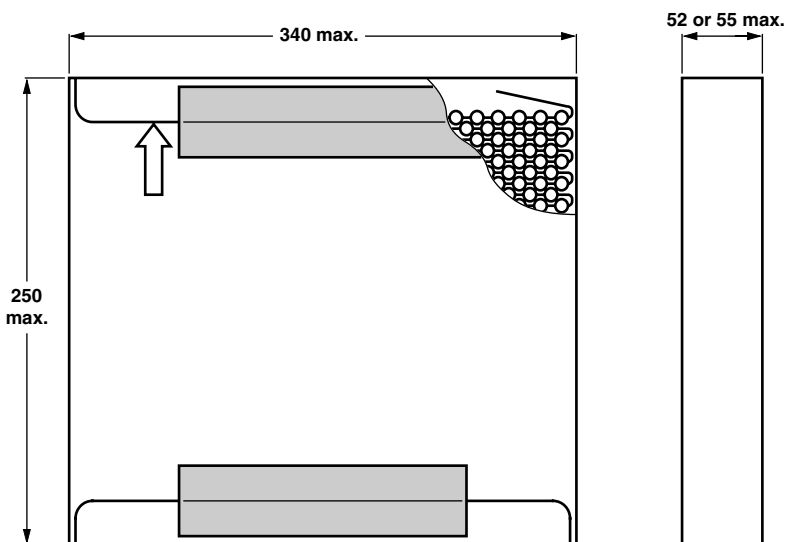
<sup>(1)</sup> Except for 35 V and 40 V = 1000 pieces

**DIMENSIONS OF AMMOPACK** in millimeters

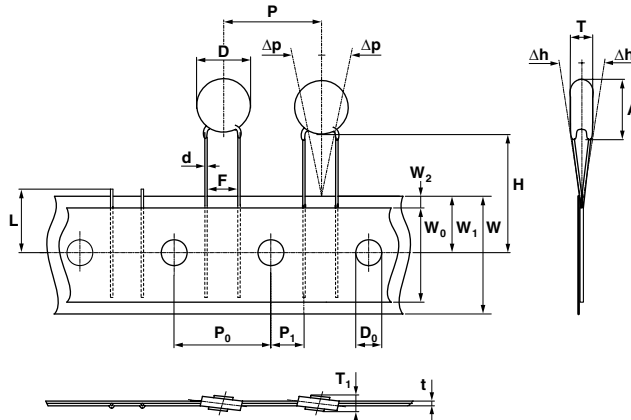
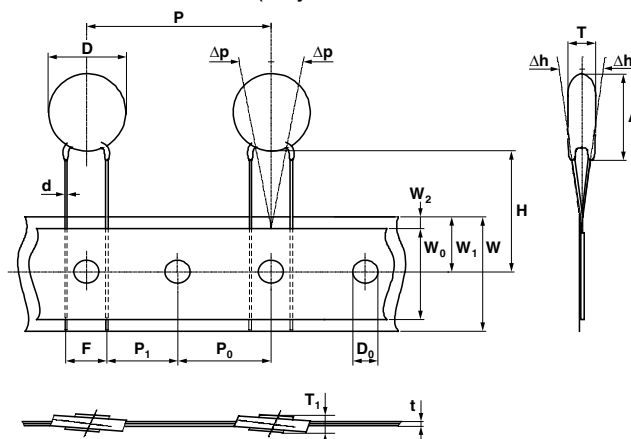

<b>VARISTORS ON TAPE AND REEL</b>				
<b>TYPE</b>	<b>VDRS05... 2381 592 ... Ø 5 mm 14 V to 460 V</b>	<b>VDRS07... 2381 593 ... Ø 7 mm 14 V to 460 V</b>	<b>VDRS10... 2381 594 ... Ø 10 mm 14 V to 550 V</b>	<b>VDRS14... 2381 595 ... Ø 14 mm 14 V to 550 V</b>
Straight leads				
H = 18 mm	-	-	TSE 0...6	TSE 0...6
H = 20 mm	TSE 0...6	TSE 0...6	-	-
See drawing: Taped version with straight leads				
Straight leads with flange				
H <sub>0</sub> = 16 mm	TGE 1...6	TGE 1...6	-	-
H <sub>0</sub> = 18.25 mm	THE 2...6	THE 2...6	-	-
See drawing: Taped version with flanged leads				
Kinked leads				
H <sub>0</sub> = 18.25 mm	TME 3...6	TME 3...6	TME 3...6	TME 3...6
H <sub>0</sub> = 16 mm	TLE 8...6	TLE 8...6	TLE 8...6	TLE 8...6
See drawing: Taped version with kinked leads				
<b>Packaging quantities</b>				
14 V to 250 V	1500	1500	1000	750
275 V to 300 V	1500	1500	750	750
320 V to 350 V	1000	1000	500	500
385 V to max. V	1000	1000	500	500

**PACKAGING**
**TAPED VERSION WITH STRAIGHT LEADS** (only for VDRS05.....E/2381 592 .... and VDRS07.....E/2381 593....)

**TAPED VERSION WITH STRAIGHT LEADS** (only for VDRS10.....E/2381 594 .... and VDRS14.....E/2381 595 ....)



**TAPED VERSION WITH KINKED LEADS**

(only for VDRS05.....E/2381 592 .... and VDRS07.....E/2381 593 ....)

**TAPED VERSION WITH KINKED LEADS**

(only for VDRS10.....E/2381 594 .... and VDRS14.....E/2381 595.....)

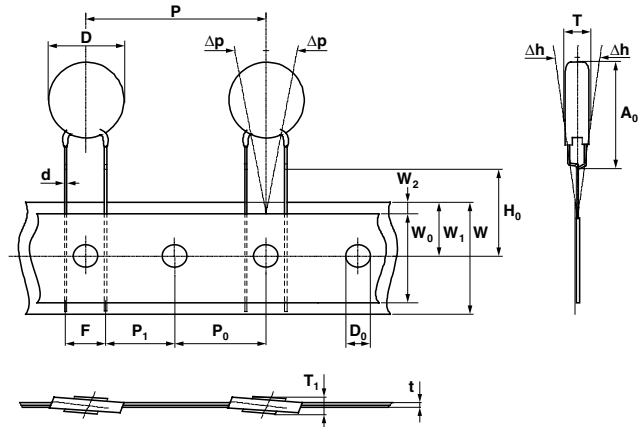
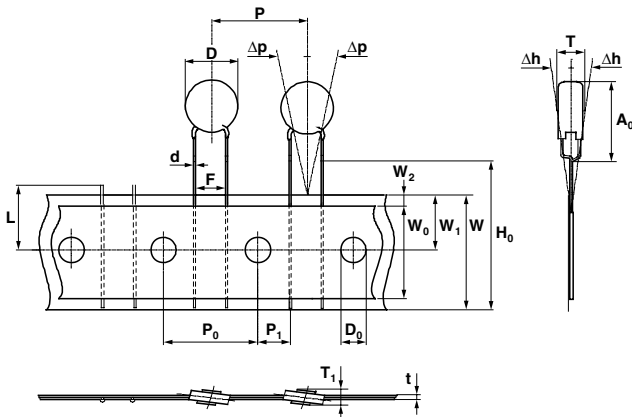

**TAPED VERSION WITH FLANGED LEADS**

(only for VDRS05.....E/2381 592 .... and VDRS07.....E/2381 593 ....)

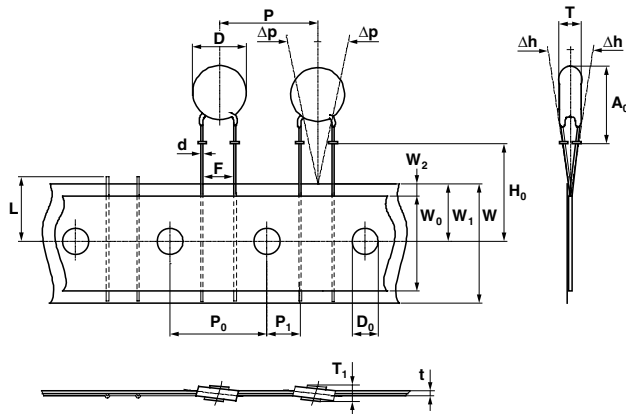

TAPING DATA (based on IEC 60286-2)		DIMENSIONS/TOLERANCE			
SYMBOL	PARAMETER	VDRS05 592	VDRS07 593	VDRS10 594	VDRS14 595
A	Mounting height	9.0 max.	11.0 max.	15.5 max.	19.0 max.
A <sub>0</sub>	Mounting height	11.0 max.	13.0 max.	18.0 max.	23.0 max.
D	Body diameter	7.0 max.	9.0 max.	13.5 max.	17.0 max.
d	Lead wire diameter	0.6 ± 0.05		0.8 ± 0.05	
F	Lead to lead distance <sup>(1)</sup>	5.0 + 0.8/- 0.2		7.5 ± 0.8	
H	Distance component to tape center <sup>(2)</sup>	20.0 + 2.0/- 0.0		18.0 + 2.0/- 0.0	
H <sub>0</sub>	Lead wire clinch height	16.0 or 18.25 ± 0.5			
P	Pitch of components on tape	12.7 ± 1.0		25.4 ± 1.0	
T	Total thickness	See Electrical Data table			

**Notes**

<sup>(1)</sup> Guaranteed between component and tape

<sup>(2)</sup> For 2381 595 0511y and 2381 595 0551y: H = 20 mm ± 1 mm



**V/I CHARACTERISTICS**

14 V<sub>RMS</sub> to 40 V<sub>RMS</sub>; VDRS05.....E/2381 592 ....

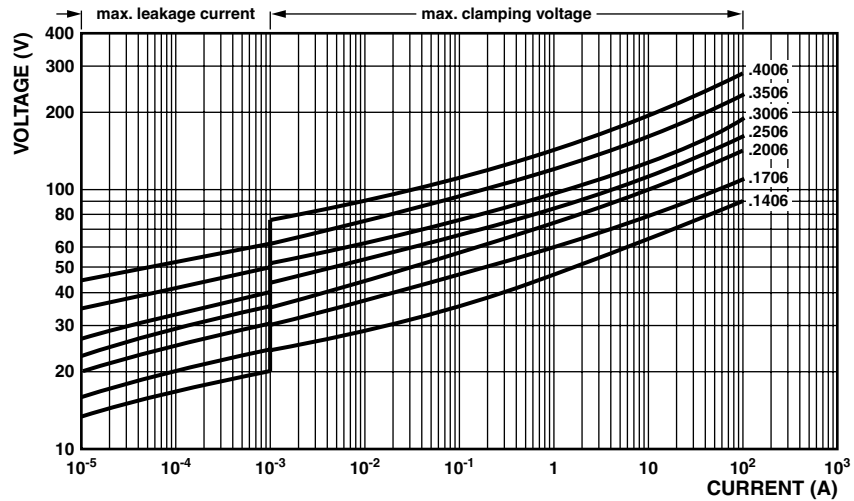

50 V<sub>RMS</sub> to 460 V<sub>RMS</sub>; VDRS05.....E/2381 592 ....

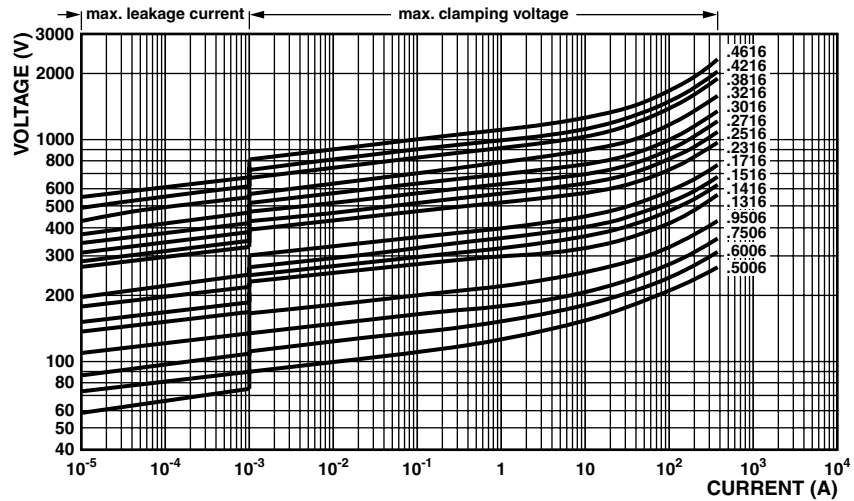

14 V<sub>RMS</sub> to 40 V<sub>RMS</sub>; VDRS07.....E/2381 593 ....

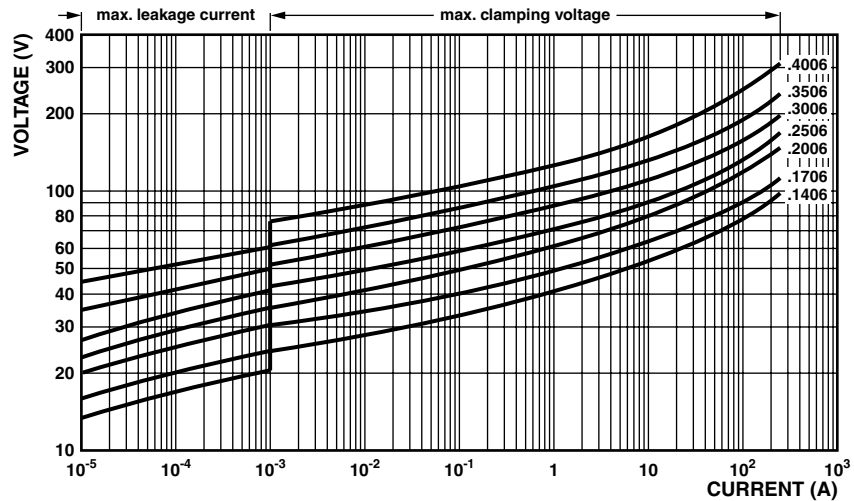

# VDRS.....E/2381 59. ....



Vishay BCcomponents VDR Metal Oxide Varistors Standard

50 V<sub>RMS</sub> to 460 V<sub>RMS</sub>; VDRS07.....E/2381 593 ....

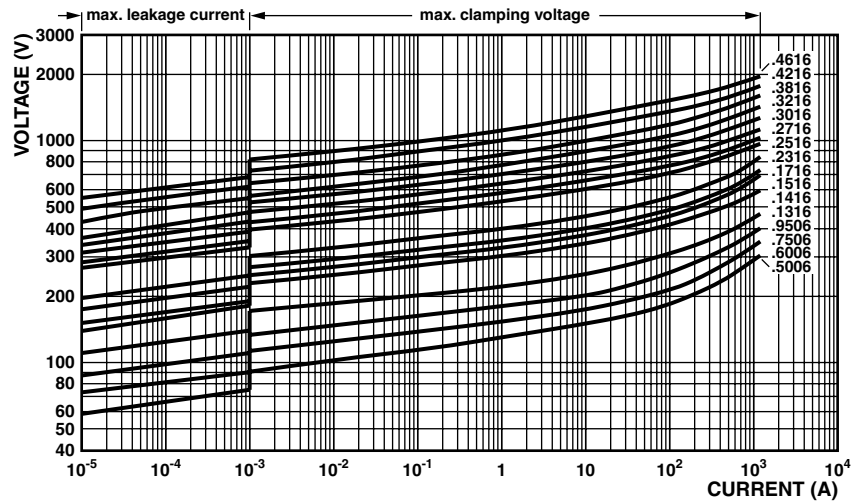

14 V<sub>RMS</sub> to 40 V<sub>RMS</sub>; VDRS10.....E/2381 594 ....

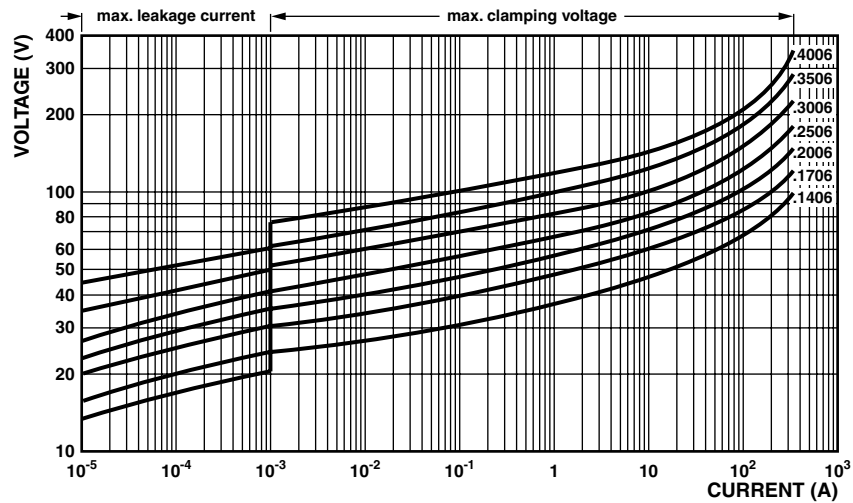

50 V<sub>RMS</sub> to 550 V<sub>RMS</sub>; VDRS10.....E/2381 594 ....

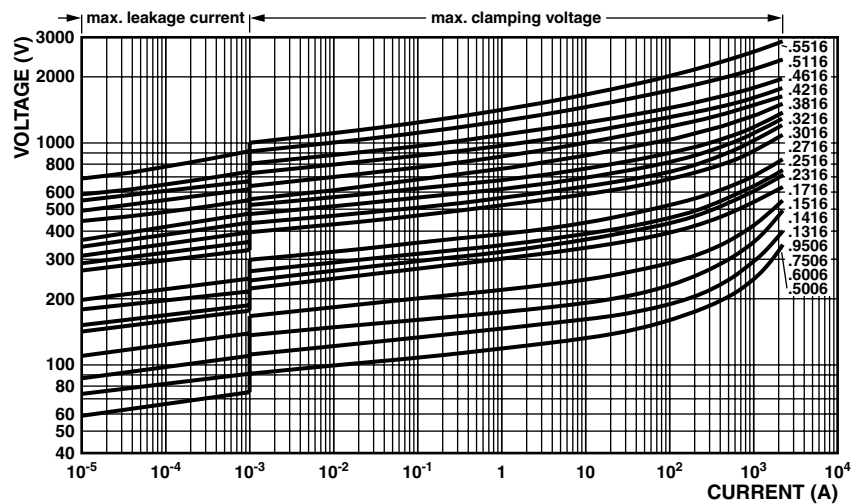



14 V<sub>RMS</sub> to 40 V<sub>RMS</sub>; VDRS14.....E/2381 595 ....

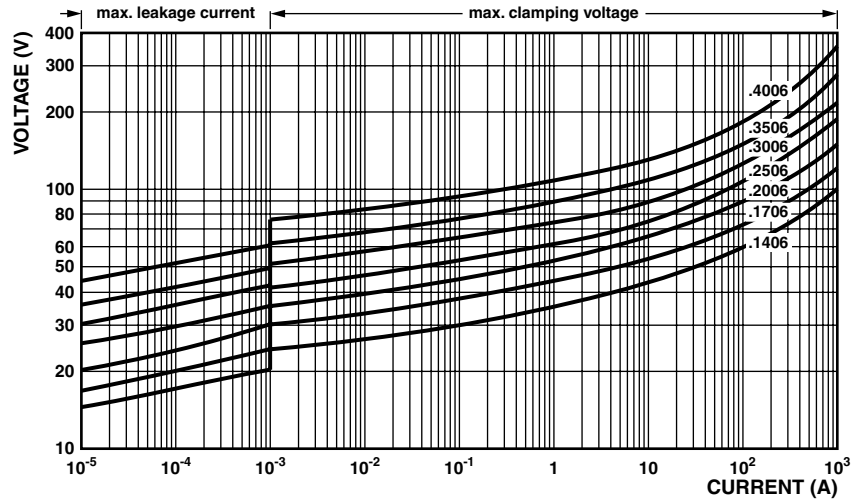

50 V<sub>RMS</sub> to 550 V<sub>RMS</sub>; VDRS14.....E/2381 595 ....

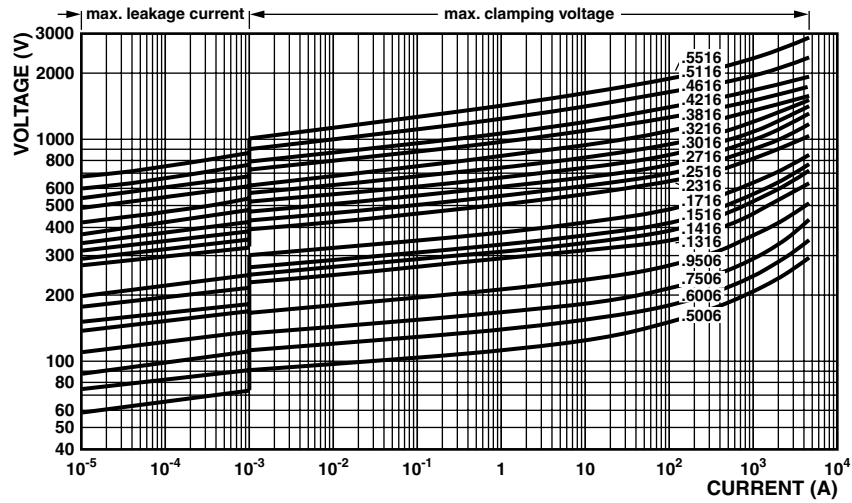

14 V<sub>RMS</sub> to 40 V<sub>RMS</sub>; VDRS20.....E/2381 596 ....

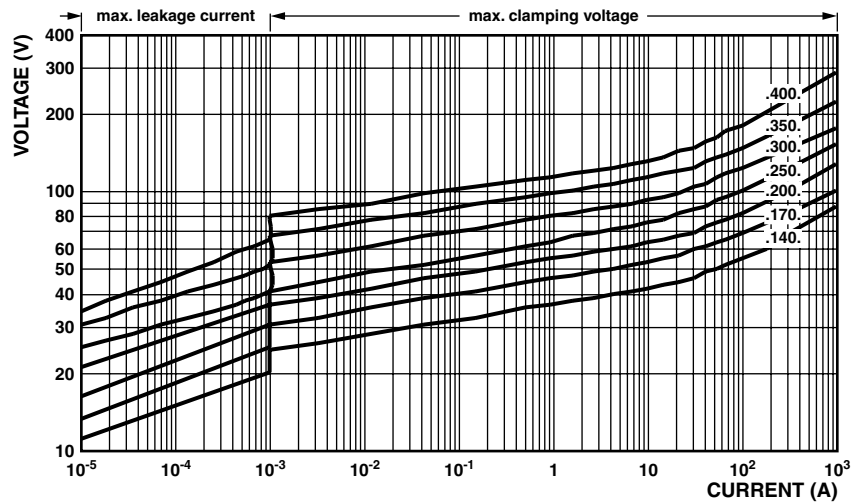

50 V<sub>RMS</sub> to 680 V<sub>RMS</sub>; VDRS20.....E/2381 596 ....

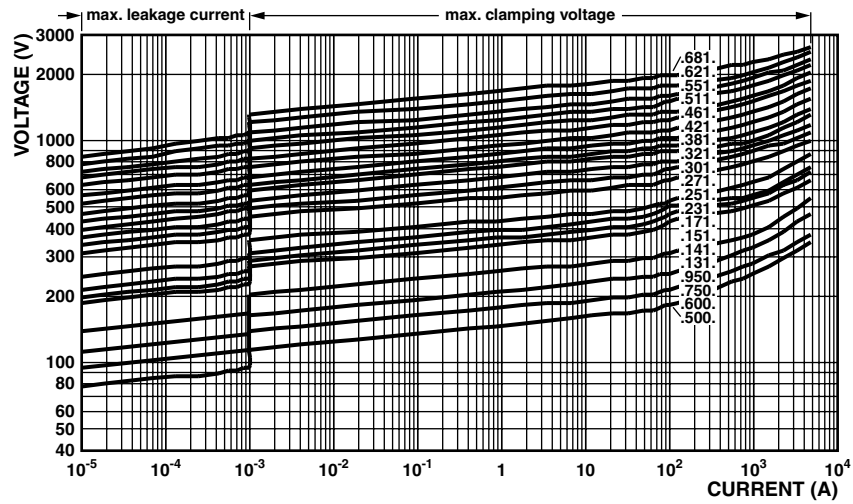

**MAXIMUM APPLICABLE TRANSIENT CURRENT AS A FUNCTION OF PULSE DURATION**

14 V<sub>RMS</sub> to 40 V<sub>RMS</sub>; VDRS05.....E/2381 592 ....

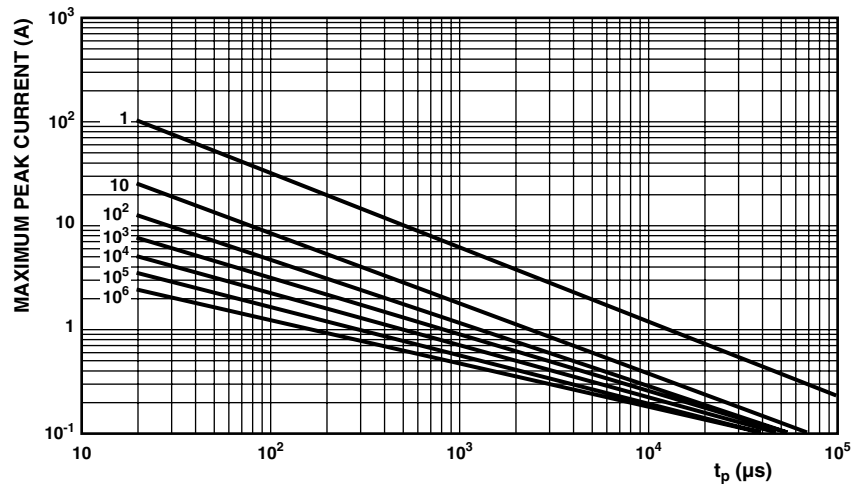

50 V<sub>RMS</sub> to 460 V<sub>RMS</sub>; VDRS05.....E/2381 592 ....

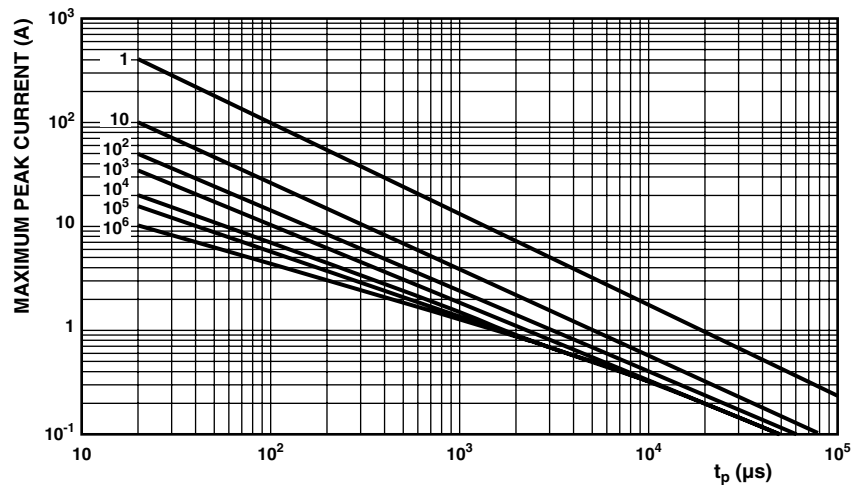



14 V<sub>RMS</sub> to 40 V<sub>RMS</sub>; VDRS07.....E/2381 593 ....

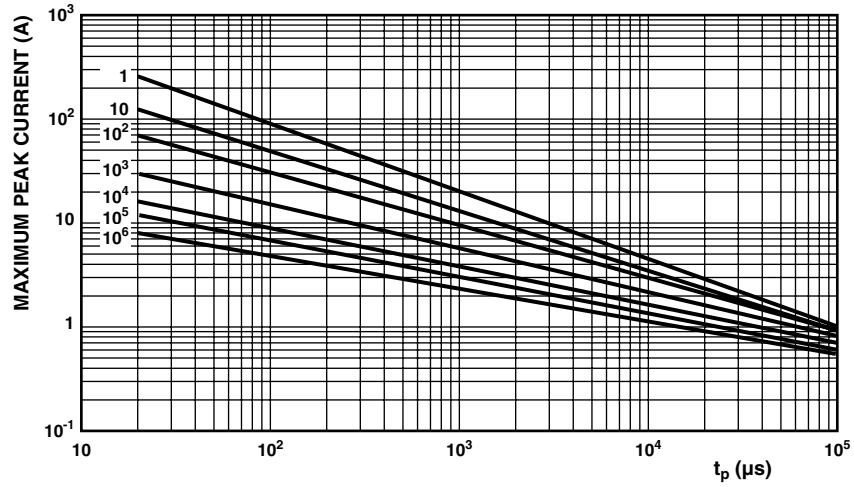

50 V<sub>RMS</sub> to 460 V<sub>RMS</sub>; VDRS07.....E/2381 593 ....

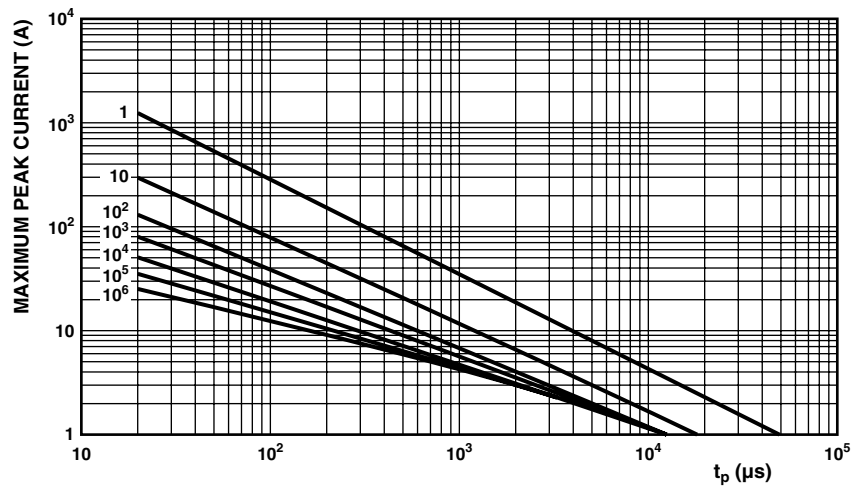

14 V<sub>RMS</sub> to 40 V<sub>RMS</sub>; VDRS10.....E/2381 594 ....

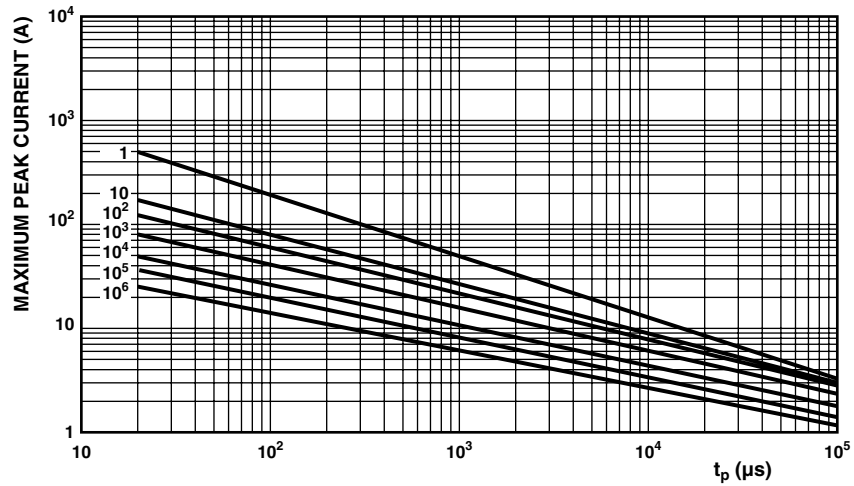

50 V<sub>RMS</sub> to 320 V<sub>RMS</sub>; VDRS10.....E/2381 594 ....

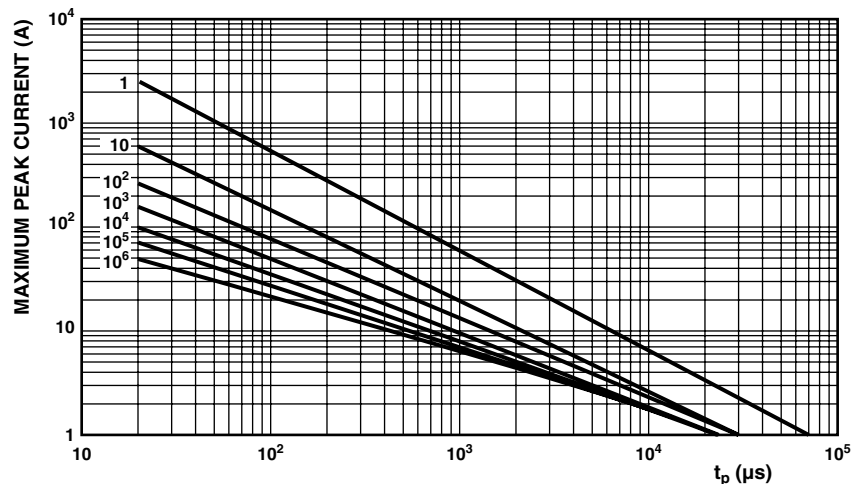

385 V<sub>RMS</sub> to 550 V<sub>RMS</sub>; VDRS10.....E/2381 594 ....

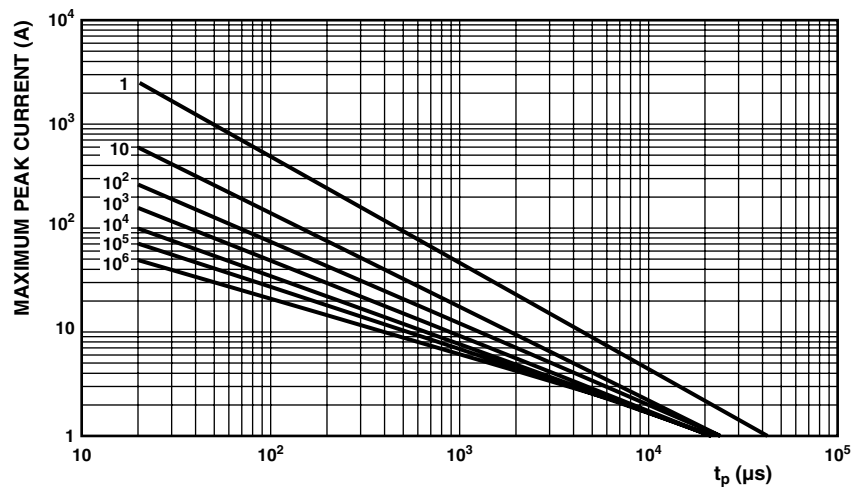

14 V<sub>RMS</sub> to 40 V<sub>RMS</sub>; VDRS14.....E/2381 595 ....

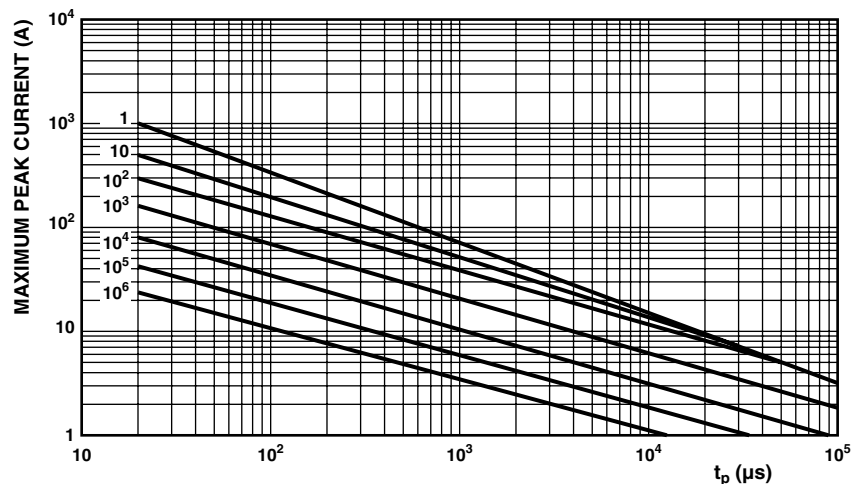



50 V<sub>RMS</sub> to 320 V<sub>RMS</sub>; VDRS14.....E/2381 595 ....

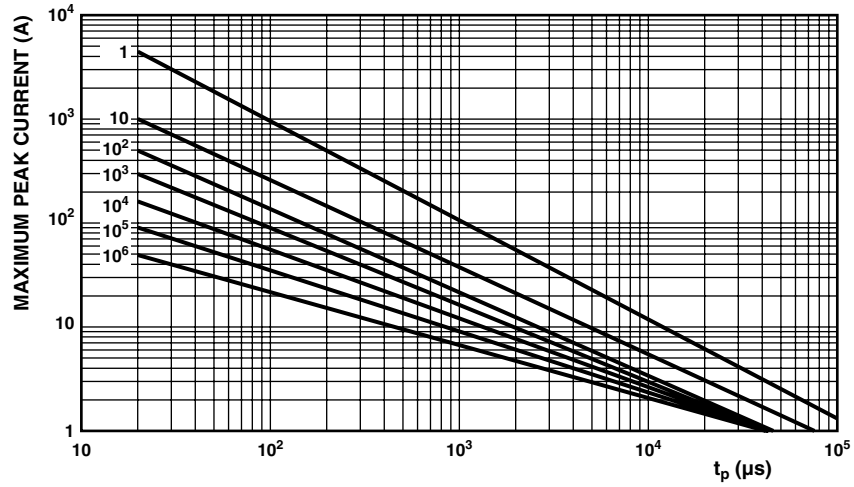

385 V<sub>RMS</sub> to 550 V<sub>RMS</sub>; VDRS14.....E/2381 595 ....

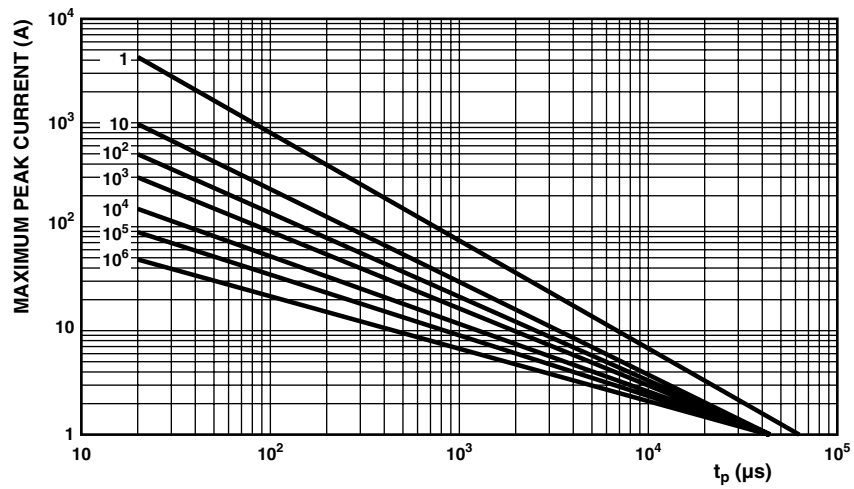

14 V<sub>RMS</sub> to 40 V<sub>RMS</sub>; VDRS20.....E/2381 596 ....

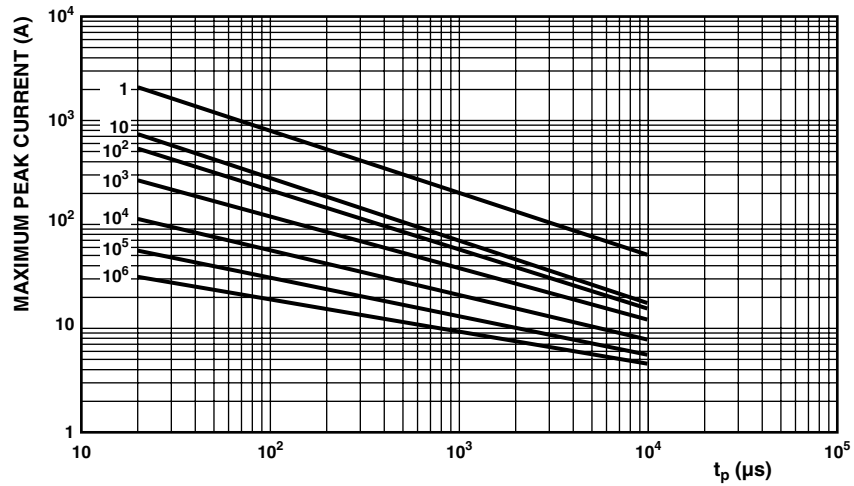



60 V<sub>RMS</sub> to 300 V<sub>RMS</sub>; VDRS20.....E/2381 596 ....

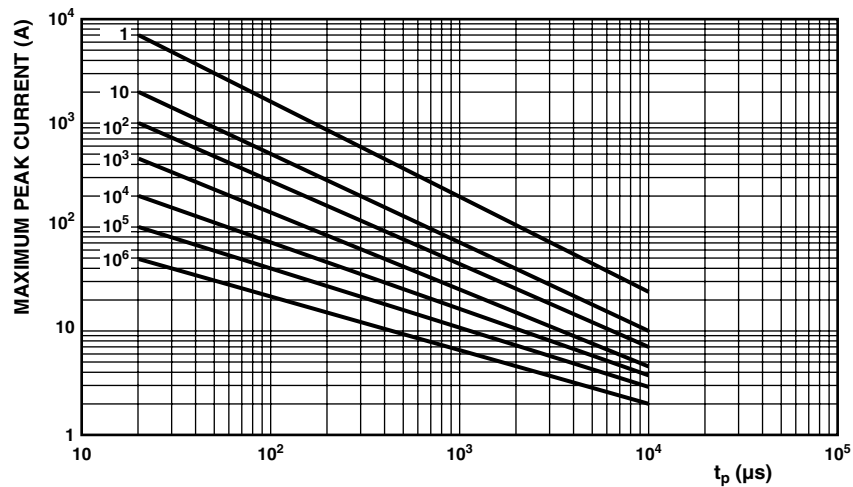

320 V<sub>RMS</sub> to 680 V<sub>RMS</sub>; VDRS20.....E/2381 596 ....

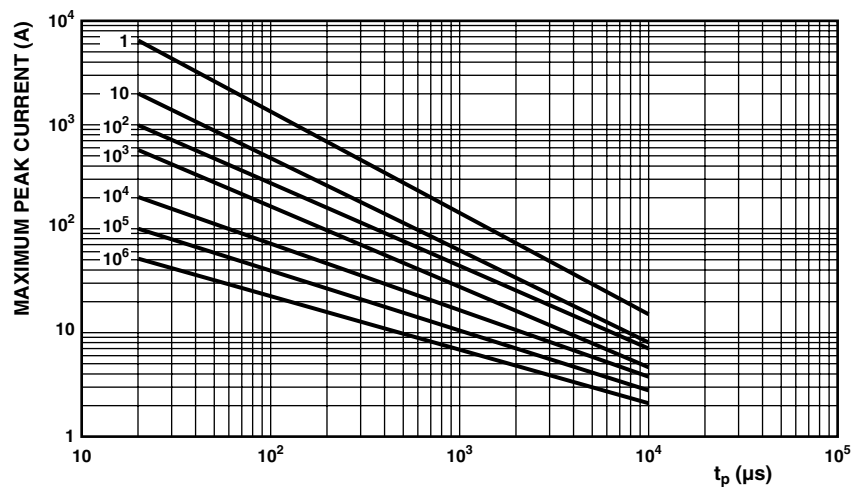



## Disclaimer

ALL PRODUCT, PRODUCT SPECIFICATIONS AND DATA ARE SUBJECT TO CHANGE WITHOUT NOTICE TO IMPROVE RELIABILITY, FUNCTION OR DESIGN OR OTHERWISE.

Vishay Intertechnology, Inc., its affiliates, agents, and employees, and all persons acting on its or their behalf (collectively, "Vishay"), disclaim any and all liability for any errors, inaccuracies or incompleteness contained in any datasheet or in any other disclosure relating to any product.

Vishay makes no warranty, representation or guarantee regarding the suitability of the products for any particular purpose or the continuing production of any product. To the maximum extent permitted by applicable law, Vishay disclaims (i) any and all liability arising out of the application or use of any product, (ii) any and all liability, including without limitation special, consequential or incidental damages, and (iii) any and all implied warranties, including warranties of fitness for particular purpose, non-infringement and merchantability.

Statements regarding the suitability of products for certain types of applications are based on Vishay's knowledge of typical requirements that are often placed on Vishay products in generic applications. Such statements are not binding statements about the suitability of products for a particular application. It is the customer's responsibility to validate that a particular product with the properties described in the product specification is suitable for use in a particular application. Parameters provided in datasheets and/or specifications may vary in different applications and performance may vary over time. All operating parameters, including typical parameters, must be validated for each customer application by the customer's technical experts. Product specifications do not expand or otherwise modify Vishay's terms and conditions of purchase, including but not limited to the warranty expressed therein.

Except as expressly indicated in writing, Vishay products are not designed for use in medical, life-saving, or life-sustaining applications or for any other application in which the failure of the Vishay product could result in personal injury or death. Customers using or selling Vishay products not expressly indicated for use in such applications do so at their own risk. Please contact authorized Vishay personnel to obtain written terms and conditions regarding products designed for such applications.

No license, express or implied, by estoppel or otherwise, to any intellectual property rights is granted by this document or by any conduct of Vishay. Product names and markings noted herein may be trademarks of their respective owners.

## Material Category Policy

**Vishay Intertechnology, Inc. hereby certifies that all its products that are identified as RoHS-Compliant fulfill the definitions and restrictions defined under Directive 2011/65/EU of The European Parliament and of the Council of June 8, 2011 on the restriction of the use of certain hazardous substances in electrical and electronic equipment (EEE) - recast, unless otherwise specified as non-compliant.**

**Please note that some Vishay documentation may still make reference to RoHS Directive 2002/95/EC. We confirm that all the products identified as being compliant to Directive 2002/95/EC conform to Directive 2011/65/EU.**

**Vishay Intertechnology, Inc. hereby certifies that all its products that are identified as Halogen-Free follow Halogen-Free requirements as per JEDEC JS709A standards. Please note that some Vishay documentation may still make reference to the IEC 61249-2-21 definition. We confirm that all the products identified as being compliant to IEC 61249-2-21 conform to JEDEC JS709A standards.**