

TO ; _____

S P E C I F I C A T I O N S

Product Name PHOTOCOUPLER

Model No. P C 8 1 4

Business dealing name

	PC814XNCSZ9F
	PC814X1CSZ9F

These specifications contain 12 pages including the cover and appendix.
This specification sheets and attached sheets shall be both side copy.
After confirmation of the contents, please be sure to send back 2 copies of the Specifications with approving signature on each.
If you have any objections, please contact us before issuing purchasing order.

Accepted by:

By : _____

Name :

Title :

Date :

By : _____

Name :

Title :

Date :

Sharp Corporation

By : 

Name : T. Ichinose,

Title : Division Manager,

Development Division. V

System Device Business Unit

Electronic Components and Devices BU

Date :

6. Dec, 2016

Reviewed by :

By : 

Name : T. Okuda

Title : Senior Manager

Date : 6. Dec, 2016

Prepared by :

By : 

Name : Y. Matsuo

Title : Supervisor

Date : 6. Dec, 2016

1. These specification sheets include materials protected under copyright of Sharp Corporation ("Sharp").
Please handle with great cares and do not reproduce or cause anyone to reproduce them without Sharp's consent.
2. When using this Sharp product, please observe the absolute maximum ratings, other conditions and instructions for use described in the specification sheets, as well as the precautions mentioned below.
Sharp assumes no responsibility for any damages resulting from use of the product which does not comply with absolute maximum ratings, other conditions and instructions for use included in the specification sheets, and the precautions mentioned below.

(Precautions)

- (1) In making catalogue or instruction manual based on the specification sheets, please verify the validity of the catalogue or instruction manuals after assembling Sharp products in customer's products at the responsibility of customer.
- (2) This Sharp product is designed for use in the following application areas ;
 - Computers • OA equipment • Telecommunication equipment (Terminal) • Measuring equipment
 - Tooling machines • Audio visual equipment • Home appliancesIf the use of the Sharp product in the above application areas is for equipment listed in paragraphs (3) or (4), please be sure to observe the precautions given in those respective paragraphs.
- (3) Appropriate measures, such as fail-safe design and redundant design considering the safety design of the overall system and equipment, should be taken to ensure reliability and safety when Sharp product is used for equipment in responsibility of customer which demands high reliability and safety in function and precision, such as ;
 - Transportation control and safety equipment (aircraft, train, automobile etc.)
 - Traffic signals • Gas leakage sensor breakers • Rescue and security equipment • Other safety equipment
- (4) Sharp product is designed for consumer goods and controlled as consumer goods in production and quality.
Please do not use this product for equipment which require extremely high reliability and safety in function and precision, such as ;
 - Space equipment • Telecommunication equipment (for trunk lines)
 - Nuclear power control equipment • Medical equipment
- (5) Please contact and consult with a Sharp sales representative if there are any question regarding interpretation of the above four paragraphs.

3. Disclaimer

The warranty period for Sharp product is one (1) year after shipment.

During the period, if there are any products problem, Sharp will repair (if applicable), replace or refund.

Except the above, both parties will discuss to cope with the problems.

The failed Sharp product after the above one (1) year period will be coped with by Sharp, provided that both parties shall discuss and determine on sharing responsibility based on the analysis results thereof subject to the above scope of warranty.

The warranty described herein is only for Sharp product itself which are purchased by or delivered to customer.

Damages arising from Sharp product malfunction or failure shall be excepted.

Sharp will not be responsible for the Sharp product due to the malfunction or failures thereof which are caused by:

- (1) storage keep trouble during the inventory in the marketing channel.
- (2) intentional act, negligence or wrong/poor handling.
- (3) equipment which Sharp products are connected to or mounted in.
- (4) disassembling, reforming or changing Sharp products.
- (5) installation problem.
- (6) act of God or other disaster (natural disaster, fire, flood, etc.)
- (7) external factors (abnormal voltage, abnormal electromagnetic wave, fire, etc.)
- (8) special environment (factory, coastal areas, hot spring area, etc.)
- (9) phenomenon which cannot be foreseen based on the practical technologies at the time of shipment.
- (10) the factors not included in the product specification sheet.

4. Please contact and consult with a Sharp sales representative for any questions about Sharp product.

5. Warranty term and warranty limits

【Warranty term】

The warranty term for the shipped product shall be for 1 year after shipping to the designated place by the ordered customer.

【Warranty limits】

SHARP supplies the replacement when this SHARP product shall be failed by SHARP's responsibility during above warranty term. However, this warranty is excluded in case of the following.

- (1) In case of improper handling and using by the customer.
- (2) In case of that the cause of the failure is caused by the reason other than this SHARP product.
- (3) In case of modification and repairing by person other than SHARP responsibility is not for SHARP.
- (4) In case of a calamity, a disaster and such as the case when that responsibility is not for SHARP.

This warranty herein means the warranty for this SHARP product itself, SHARP takes no responsibility for any damage caused by the failure of this SHARP product.

1. Application

This specification applies to the outline and characteristics of photocoupler Model No. PC814. (Lead free and Halogen free type).

2. Outline Refer to the attached sheet, page 4.

3. Ratings and characteristics Refer to the attached sheet, page 5, 6.

4. Reliability Refer to the attached sheet, page 7.

5. Outgoing inspection Refer to the attached sheet, page 8.

6. Supplement

6.1 Isolation voltage shall be measured in the following method.

- (1) Short between anode and cathode on the primary side and between collector and emitter on the secondary side.
- (2) The dielectric withstanding tester with zero-cross circuit shall be used.
- (3) The wave form of applied voltage shall be a sine wave.
(It is recommended that the isolation voltage be measured in insulation oil.)

6.2 Package specifications Refer to the attached sheet, page 9, 10.

6.3 Collector current (Ic) Delivery rank table ("○" mark indicates business dealing name of ordered product)

Rank at delivery	Business dealing name	Rank mark	Ic (mA)
	PC814XNCSZ9F	with or without	0.2 to 3.0
	PC814X1CSZ9F	A	0.5 to 1.5

Test conditions
$I_F = \pm 1\text{mA}$ $V_{CE} = 5\text{V}$ $T_a = 25^\circ\text{C}$

6.4 This Model is approved by UL.

Approved Model No. : PC814

UL file No. : E64380

6.5 This photocoupler is designed for AC input.

6.6 This product is not designed against irradiation.

This product is assembled with electrical input and output.

This product incorporates non-coherent light emitting diode.

6.7 ODS materials

This product shall not contain the following materials.

Also, the following materials shall not be used in the production process for this product.

Materials for ODS : CFCs, Halon, Carbon tetrachloride, 1.1.1-Trichloroethane (Methyl chloroform)

6.8 Specified brominated flame retardants

Specified brominated flame retardants (PBB and PBDE) are not used in this device at all.

6.9 Compliance with each regulation

(1) The RoHS directive (2002/95/EC)

This product complies with the RoHS directive (2002/95/EC) .

Object substances: mercury, lead, cadmium, hexavalent chromium, polybrominated biphenyls (PBB) and polybrominated diphenyl ethers (PBDE)

(2) Content of six substances specified in Management Methods for Control of Pollution Caused by Electronic Information

Products Regulation (Chinese : 电子信息产品污染控制管理办法).

Category	Toxic and hazardous substances					
	Lead (Pb)	Mercury (Hg)	Cadmium (Cd)	Hexavalent chromium (Cr ⁶⁺)	Polybrominated biphenyls (PBB)	Polybrominated diphenyl ethers (PBDE)
Photocoupler	✓	✓	✓	✓	✓	✓

✓ : indicates that the content of the toxic and hazardous substance in all the homogeneous materials of the part is below the concentration limit requirement as described in SJ/T 11363-2006 standard .

(3) This product complies with “Halogen free”.

“Halogen free” about this product is defined as follows.

The concentration ratio of Chlorinate and Bromine in raw material and indirect material , finished product can not exceed 900 ppm, the total concentration of the 2 substance should not exceed 1500 ppm.

7. Notes

Precautions for photocouplers : Attachment-1

2. Outline

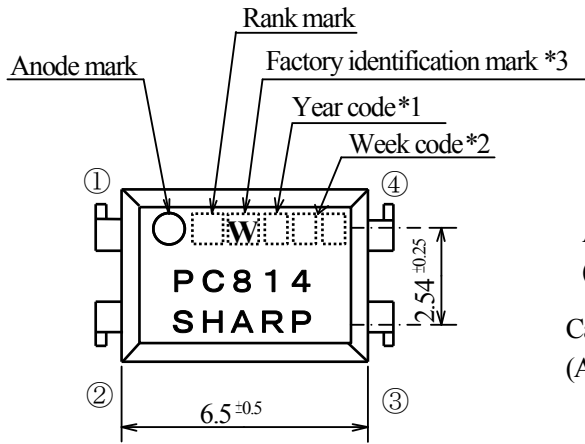

Pin-Number and internal connection diagram

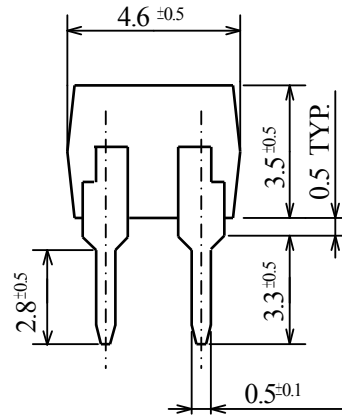
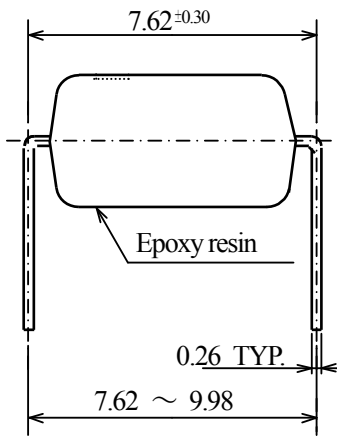
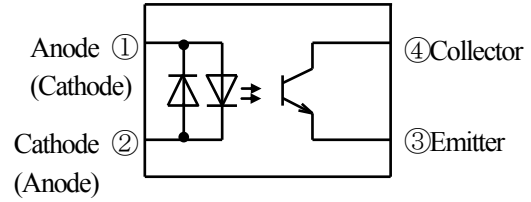

- *1) 1-digit year code
- *2) 2-digit work week code
- *3) Factory identification marks applies to the below
W : Lite-ON OPTO Technology (Changzhou) Co., Ltd. (CHINA)

Pin material : Cu Alloy
Pin finish : Pure Tin plating

Product mass : Approx. 0.23 g

Marking is laser marking

UNIT : 1/1 mm	
Name	PC814 Outline Dimensions (Business dealing name : PC814X*CSZ9F)

3. Ratings and characteristics

3.1 Absolute maximum ratings

Ta=25°C

Parameter		Symbol	Rating	Unit
Input	*1 Forward current	I_F	± 50	mA
	Peak forward current	I_{FM}	± 1	A
	Power dissipation	P	70	mW
Output	Collector-emitter voltage	V_{CEO}	80	V
	Emitter-collector voltage	V_{ECO}	6	V
	Collector current	I_c	50	mA
	*1 Collector power dissipation	P_c	150	mW
Total power dissipation		P_{tot}	200	mW
Operating temperature		T_{opr}	-30 to +100	°C
Storage temperature		T_{stg}	-55 to +125	°C
*2 Isolation voltage		$V_{iso(tms)}$	5	kV
*3 Soldering temperature		T_{sol}	270	°C

*1 The derating factors of absolute maximum ratings due to ambient temperature are shown in Fig. 1 to 2.

*2 AC For 1 min, 40 to 60%RH

Isolation voltage shall be measured using the following method.

(1) Short between anode and cathode on the primary side and between collector and emitter on the secondary side.

(2) The isolation voltage tester with zero-cross circuit shall be used.

(3) The waveform of applied voltage shall be a sine wave.

*3 For 10s

3.2 Electro-optical characteristics

Ta=25°C

Parameter		Symbol	Condition	MIN.	TYP.	MAX.	Unit
Input	Forward voltage	V_F	$I_F = \pm 20mA$	-	1.2	1.4	V
	Peak forward voltage	V_{FM}	$I_{FM} = \pm 0.5A$	-	-	3.0	V
	Terminal capacitance	C_t	$V=0, f=1kHz$	-	30	250	pF
Output	Dark current	I_{CEO}	$V_{CE}=50V, I_F=0$	-	-	100	nA
	Collector-emitter breakdown voltage	BV_{CEO}	$I_c=0.1mA, I_F=0$	80	-	-	V
	Emitter-collector breakdown voltage	BV_{ECO}	$I_E=10\mu A, I_F=0$	6	-	-	V
Transfer characteristics	Collector current	I_c	$I_F = \pm 1mA, V_{CE}=5V$	0.2	-	3.0	mA
	*4 Current Transfer Ratio	CTR		20	-	300	%
	Collector-emitter saturation voltage	$V_{CE(sat)}$	$I_F=20mA, I_c=1mA$	-	0.1	0.2	V
	Isolation resistance	R_{ISO}	DC500V 40 to 60%RH	5×10^{10}	10^{11}	-	Ω
	Floating capacitance	C_f	$V=0, f=1MHz$	-	0.6	1.0	pF
	Cut-off frequency	f_c	$V_{CE}=5V, I_c=2mA$ $R_L=100\Omega, -3dB$	-	80	-	kHz
	Rise time	t_r	$V_{CE}=2V, I_c=2mA$ $R_L=100\Omega$	-	4	18	μs
	Fall time	t_f	$V_{CE}=2V, I_c=2mA$ $R_L=100\Omega$	-	3	18	μs

*4 $CTR(\%) = (I_c / I_F) \times 100$

(Fig. 1) Forward current vs. ambient temperature

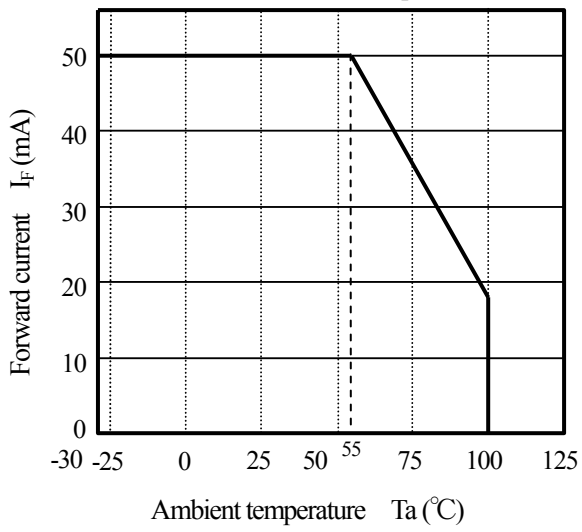

(Fig. 2) Collector power dissipation vs. ambient temperature

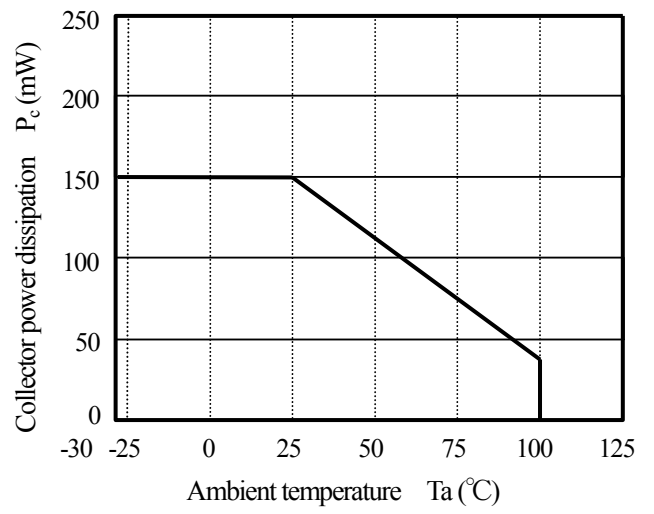

4. Reliability

The reliability of products shall satisfy items listed below.

Test item as require

No.	Test title	Test condition
1	Pre-condition test	125°C=24h, 85°C 85%RH=168h, and IR reflow 260°C peak=3 cycles
2	Temperature cycling test	Ta=-55~125°C, Dwell time=15min per zone, 1000 cycles
3	Room temperature operation life test	Ta=25°C, I _F =50mA, 1000h
4	High temperature operation life test	Ta=110°C, I _F =20mA, P _C =22.5mW, 1000h
5	High temperature & high humidity bias test	Ta=85°C, 85%RH, V _{CE} =64V(=BV _{CEO} × 4/5), 1000h
6	High temperature bias test	Ta=110°C, V _{CE} =80V, 1000h
7	High temperature storage test	Ta=150°C, 1000h
8	Low temperature storage test	Ta=-55°C, 1000h
9	Autoclave	Temperature=121°C, 100%RH and 15Psi, 168h

Specification of product for reliability

Ta=25°C

No.	Parameter	Symbol	Measurement condition	MIN.	MAX.	Unit
1	Forward voltage	V _F	I _F =±20mA	-	1.4	V
2	Dark current	I _{CEO}	V _{CE} =50V	-	100	nA
3	Collector-emitter breakdown voltage	BV _{CEO}	I _C =0.1mA	80	-	V
4	Emitter-collector breakdown voltage	BV _{ECO}	I _E =10μ A	6	-	V
5	Collector-emitter saturation voltage	V _{CE(sat)}	I _F =±20mA, I _C =1mA	-	0.2	V
6	Current Transfer Ratio	CTR	I _F =±5mA, V _{CE} =5V	20	300	%

Reliability judgment criteria

Symbol	Failure Judgment Criteria	
V _F	U.S.L. × 1.5 < V _F	U.S.L. : Upper reliability specification limit L.S.L. : Lower reliability specification limit
BV _{CEO}	BV _{CEO} < L.S.L. × 0.5	
BV _{ECO}	BV _{ECO} < L.S.L. × 0.5	
CTR	CTR < L.S.L. × 0.5	
I _{CEO}	U.S.L. < I _{CEO}	
V _{CE(sat)}	U.S.L. < V _{CE(sat)}	

Short and open is criteria of Temperature cycling test and Autoclave item.

5. Outgoing inspection

5.1 Inspection items

(1) Appearance

5.2 Sampling method and Inspection level

A single sampling plan, normal inspection level II based on ISO 2859 is applied.

The AQL according to the inspection items are shown below.

Defect	Inspection item	AQL (%)
Major defect	Unreadable marking	0.15
Minor defect	Appearance defect except the above mentioned.	0.65

6.2 Packing specification

6.2.1 Package materials

Name	Materials
Sleeve	PS
Stopper	TPR(Thermoplastic rubber)
Packing case (Inner box)	Paper
Packing case (Outer carton)	

6.2.2 Packing data

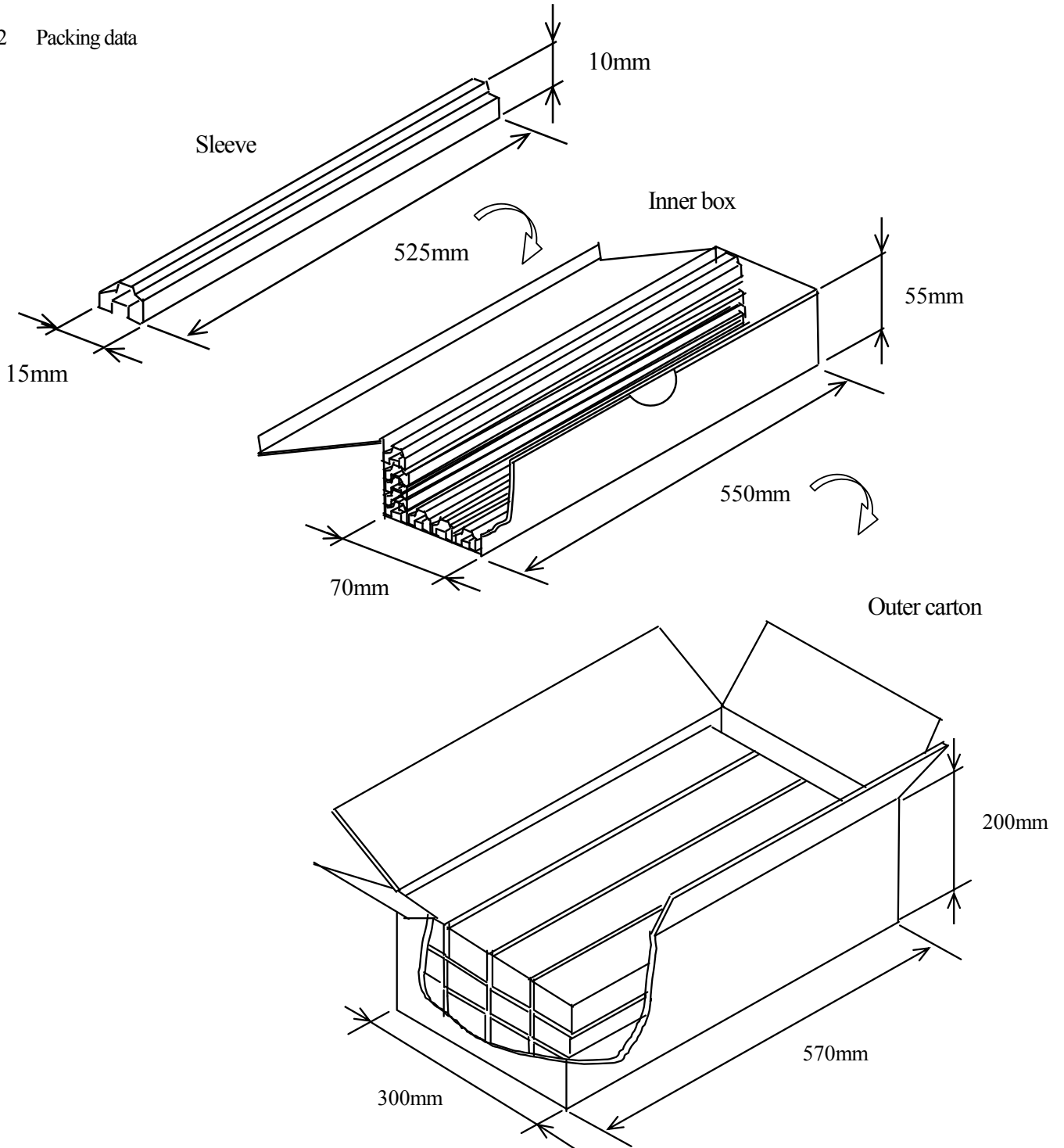

Sleeve volume (pcs/sleeve)	Inner box volume (sleeve/box)	Outer carton volume (box/carton)	Total volume (pcs/outer carton)
100	20	12	24000

6.2.3 Sleeve and Stopper data

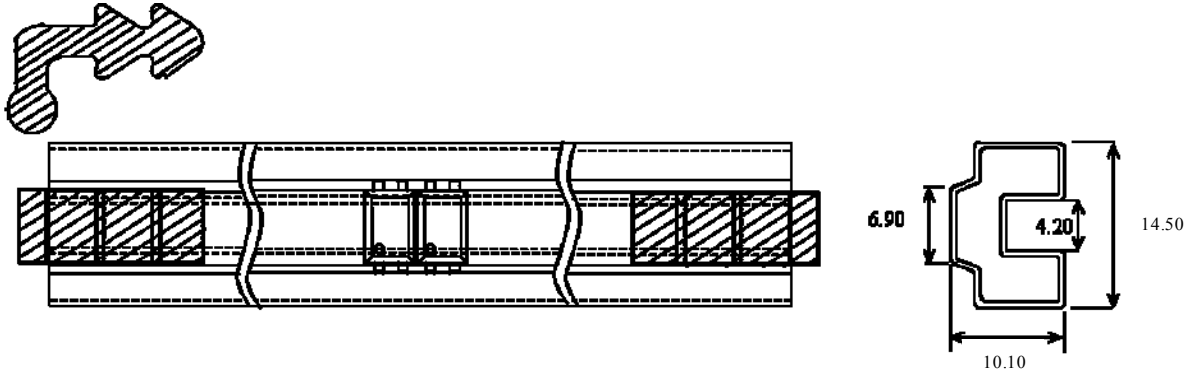

All dimensions are in millimeters.

Precautions for Photocouplers

1. Cleaning

- (1) Solvent cleaning : Solvent temperature 45°C or less
Immersion for 3 min or less
- (2) Ultrasonic cleaning : The effect to device by ultrasonic cleaning differs by cleaning bath size, ultrasonic power output, cleaning time, PCB size or device mounting condition etc. Please test it in actual using condition and confirm that any defect doesn't occur before starting the ultrasonic cleaning.
- (3) Applicable solvent : Ethyl alcohol, Methyl alcohol, Isopropyl alcohol
When the other solvent is used, there are cases that the packaging resin is eroded.
Please use the other solvent after thorough confirmation is performed in actual using condition.

2. Circuit design

- 2.1 The LED used in the Photocoupler generally decreases the light emission power by operation.
In case of long operation time, please design the circuit in consideration of the degradation of the light emission power of the LED. (50%/5years)
- 2.2 There are cases that the deviation of the CTR and the degradation of the relative light emission power of the LED increase when the setting value of I_F is less than 1.0mA. Please design the circuit in consideration of this point.

3. Precautions for Soldering

- (1) In the case of flow soldering (Avoid immersing units body in the solder)
One time soldering is recommended within the condition of temperature.
Temperature: 260+0/-5°C
Time: 10 s.
Preheat temperature: 25 to 140°C
Preheat time: 30 to 80 s

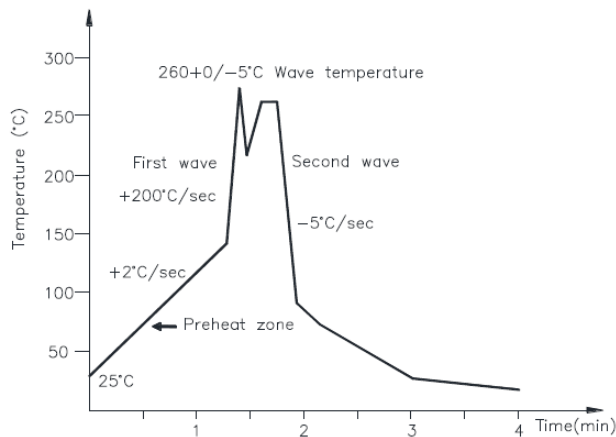

- (2) In the case of hand soldering by soldering iron
Allow single lead soldering in every single process. One time soldering is recommended.
Temperature: 380+0/-5°C
Time: (max.) 3s
- (3) Other precautions
Depending on equipment and soldering conditions (temperature, Using solder etc.), the effect to the device and the PCB is different.
Please confirm that there is no problem on the actual use conditions in advance.

Mouser Electronics

Authorized Distributor

Click to View Pricing, Inventory, Delivery & Lifecycle Information:

[Sharp Microelectronics:](#)

[PC814X1CSZ9F](#)