

# SST-25-WES

## High Power White LEDs

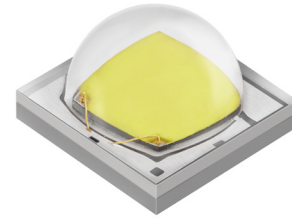

### Features

- The high power cool white LEDs with typical output of 1500 lm @ 3.75 A, 85°C
- Vertical chip with high lumen density and small emitting angle, ideal for efficient optical beam shaping to achieve high intensity, narrow beam angle and long beam distance.
- Phosphor-on-chip with superior color uniformity over radiation angles, enabling excellent light quality of beam spots in directional lighting.
- Maximum Drive Current: 3.75 A
- Color Temperature: 5000K, 5700K, 6500 K
- Color Rendering Index: Min. 70 (5000K, 5700K), Typ. 70 (6500K)
- Low thermal resistance: 1.2°C/W
- ANSI-compatible chromaticity bins
- Electrically isolated thermal path
- 8 kV HBM ESD rating per ANSI/ESDA/JEDEC JS-001

### Table of Contents

Ordering Information. . . . .	2
Binning Structure. . . . .	3
Absolute Maximum Ratings . . . . .	7
Product Characteristics . . . . .	7
Soldering Profile. . . . .	10
Mechanical Dimensions. . . . .	11
Tape and Reel Outline . . . . .	12
Shipping Label . . . . .	13
Packaging . . . . .	14
Notes . . . . .	15



### Applications

- Portable Lights
- LED Work Lights
- Bicycle Lights
- Industrial Lights



## Ordering Information

### Ordering Part Numbers<sup>1</sup>

CRI	CCT	Luminous Flux		Chromaticity Bin Kit <sup>3</sup>	Ordering Part Number
		Minimum Flux Bin <sup>1</sup>	Minimum Flux <sup>2</sup>		
Min. 70	5000K	F9	640 lm	501	SST-25-WE50-A2-F9501
				502	SST-25-WE50-A2-F9502
		G1	680 lm	501	SST-25-WE50-A2-G1501
				502	SST-25-WE50-A2-G1502
		G2	720 lm	501	SST-25-WE50-A2-G2501
				502	SST-25-WE50-A2-G2502
	5700K	F9	640 lm	571	SST-25-WE57-A2-F9571
				572	SST-25-WE57-A2-F9572
		G1	680 lm	571	SST-25-WE57-A2-G1571
				572	SST-25-WE57-A2-G1572
		G2	720 lm	571	SST-25-WE57-A2-G2571
				572	SST-25-WE57-A2-G2572
Typ. 70 Min. 65	6500K	F9	640 lm	651	SST-25-WS65-A2-F9651
				652	SST-25-WS65-A2-F9652
				703	SST-25-WS65-A2-F9703
		G1	680 lm	651	SST-25-WS65-A2-G1651
				652	SST-25-WS65-A2-G1652
		G2	720 lm	651	SST-25-WS65-A2-G2651
652	SST-25-WS65-A2-G2652				

**Note:**

1. The Ordering Part Number specifies the Minimum Flux Bin in shipment; higher flux bins may be shipped without advance notice. Please refer to 'Luminous Flux Binning' table for details of all flux bins.
2. Product test condition:  $I_f = 1500 \text{ mA}$ ,  $T_j = 85^\circ\text{C}$ .
3. Shipments always adhere to the color bins specified in each Chromaticity Bin Kit. See 'Chromaticity Bin Kit Codes' table for the color bins included in each Bin Kit.



## Ordering Information

### Part Number Nomenclature

SST

25

W<yxx>

<p#>

<ffccc>

Product Family	Chip Area	Color	Package Configuration	Bin Kit
<b>S:</b> Surface Mount <b>S:</b> Dome Lensed <b>T:</b> Single Emitter	<b>25:</b> 2.5 mm <sup>2</sup>	<b>W:</b> White <b>&lt;y&gt;</b> CRI Category Code <b>E:</b> CRI>70 <b>S:</b> CRI>65 <b>&lt;xx&gt;</b> Color Temperature <b>50:</b> 5000K <b>65:</b> 6500K	<b>&lt;p&gt;</b> Solder Pad Configuration <b>A:</b> type A - see page 11 <b>&lt;#&gt;</b> Chip Generation <b>2:</b> Gen 2	<b>&lt;ff&gt;</b> Minimum Flux Bin, see 'Luminus Flux Binning' table for details <b>&lt;ccc&gt;</b> Chromaticity Bin Kit, see 'Chromaticity Bin Kit Codes' table for details



## Binning Structure

### Luminous Flux Binning<sup>1,2</sup>

Flux Bin Code	Binning @ 1500 mA			Correlated Minimum Flux (lm) @ $T_j=85^\circ\text{C}^2$			
	$T_j=85^\circ\text{C}$		$T_j=25^\circ\text{C}$				
	Minimum Flux (lm)	Maximum Flux (lm)	Minimum Flux (lm)	700 mA	2000 mA	3000 mA	3750 mA
F9	640	680	717	326	813	1120	1312
G1	680	720	762	347	864	1190	1394
G2	720	760	806	367	914	1260	1476
G3	760	815	851	388	965	1330	1558

### Forward Voltage Binning<sup>3</sup>

Voltage Bin Code <sup>3</sup>	Binning @ 1500 mA, $T_j=85^\circ\text{C}$	
	Minimum Voltage (V)	Maximum Voltage (V)
VJ	2.7	2.9
VK	2.9	3.1
VL	3.1	3.3

**Note:**

- LEDs are measured at 25°C ambient temperature with 1500 mA 20 ms single pulse. The measured values are correlated to values at 85°C junction temperature ( $T_j$ ). Luminus maintains a  $\pm 6\%$  tolerance on flux measurement.
- Flux values at other junction temperature ( $T_j$ ) and/or forward current conditions are calculated and for reference only.
- Individual bins are not orderable.



## Binning Structure

### Chromaticity Binning Coordinates

CCT	Bin Code	CIE <sub>x</sub>	CIE <sub>y</sub>	Bin Code	CIE <sub>x</sub>	CIE <sub>y</sub>	Bin Code	CIE <sub>x</sub>	CIE <sub>y</sub>	Bin Code	CIE <sub>x</sub>	CIE <sub>y</sub>
5000K	DA	0.3371	0.3490	DB	0.3376	0.3616	DC	0.3463	0.3687	DD	0.3451	0.3554
		0.3451	0.3554		0.3463	0.3687		0.3551	0.3760		0.3533	0.3620
		0.3440	0.3427		0.3451	0.3554		0.3533	0.3620		0.3515	0.3487
		0.3366	0.3369		0.3371	0.3490		0.3451	0.3554		0.3440	0.3427
	DH	0.3366	0.3369	DE	0.3381	0.3762	DF	0.3480	0.3840	DG	0.3440	0.3428
		0.3440	0.3428		0.3480	0.3840		0.3571	0.3907		0.3515	0.3487
		0.3429	0.3307		0.3463	0.3687		0.3551	0.3760		0.3495	0.3339
		0.3361	0.3245		0.3376	0.3616		0.3463	0.3687		0.3429	0.3307
5700K	CA	0.3215	0.3350	CB	0.3207	0.3462	CC	0.3290	0.3538	CD	0.3290	0.3417
		0.3290	0.3417		0.3290	0.3538		0.3376	0.3616		0.3371	0.3490
		0.3290	0.3300		0.3290	0.3417		0.3371	0.3490		0.3366	0.3369
		0.3222	0.3243		0.3215	0.3350		0.3290	0.3417		0.3290	0.3300
	CH	0.3222	0.3243	CE	0.3196	0.3602	CF	0.3290	0.3690	CG	0.3290	0.3300
		0.3290	0.3300		0.3290	0.3690		0.3381	0.3762		0.3366	0.3369
		0.3290	0.3180		0.3290	0.3538		0.3376	0.3616		0.3361	0.3245
		0.3231	0.3120		0.3207	0.3462		0.3290	0.3538		0.3290	0.3180
6500K	BA	0.3048	0.3207	BB	0.3028	0.3304	BC	0.3115	0.3391	BD	0.3130	0.3290
		0.3130	0.3290		0.3115	0.3391		0.3205	0.3481		0.3213	0.3373
		0.3144	0.3186		0.3130	0.3290		0.3213	0.3373		0.3221	0.3261
		0.3068	0.3113		0.3048	0.3207		0.3130	0.3290		0.3144	0.3186
	BH	0.3068	0.3113	BE	0.3005	0.3415	BF	0.3099	0.3509	BG	0.3144	0.3186
		0.3144	0.3186		0.3099	0.3509		0.3196	0.3602		0.3221	0.3261
		0.3161	0.3059		0.3115	0.3391		0.3205	0.3481		0.3231	0.3120
		0.3093	0.2993		0.3028	0.3304		0.3115	0.3391		0.3161	0.3059
7500K	AA	0.2950	0.297	AB	0.2920	0.3060	AC	0.2984	0.3133	AD	0.2984	0.3133
		0.2920	0.306		0.2895	0.3135		0.2962	0.3220		0.3048	0.3207
		0.2984	0.3133		0.2962	0.3220		0.3028	0.3304		0.3068	0.3113
		0.3009	0.3042		0.2984	0.3133		0.3048	0.3207		0.3009	0.3042
	AH	0.2980	0.2880	AE	0.2895	0.3135	AF	0.2962	0.3220	AG	0.3037	0.2937
		0.2950	0.2970		0.2870	0.3210		0.2937	0.3312		0.3009	0.3042
		0.3009	0.3042		0.2937	0.3312		0.3005	0.3415		0.3068	0.3113
		0.3037	0.2937		0.2962	0.3220		0.3028	0.3304		0.3093	0.2993



## Binning Structure

Chromaticity Binning Diagram<sup>1</sup>

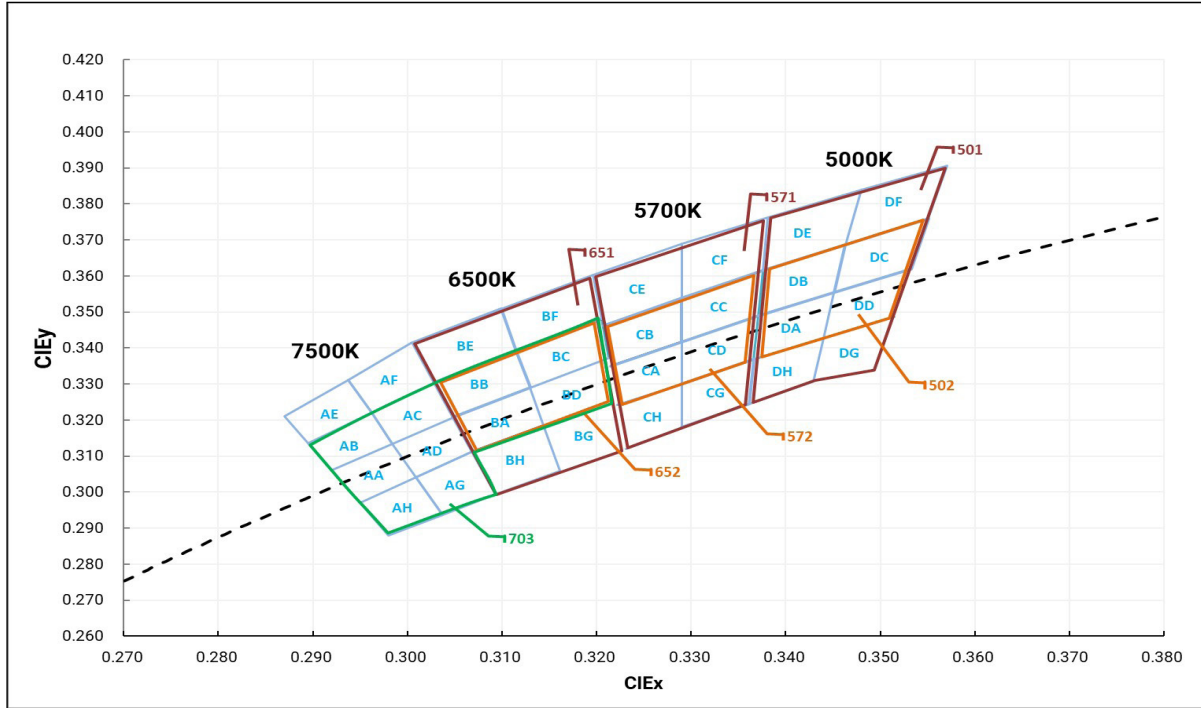

Chromaticity Bin Kit Codes

CCT	Bin Kit	Chromaticity Bins
5000K	501	DA, DB, DC, DD, DE, DF, DG, DH
	502	DA, DB, DC, DD
5700K	571	CA, CB, CC, CD, CE, CF, CG, CH
	572	CA, CB, CC, CD
6500K	651	BA, BB, BC, BD, BE, BF, BG, BH
	652	BA, BB, BC, BD
6500K - 7500K	703	AA, AB, AC, AD, AG, AH, BA, BB, BC, BD

**Note:**

- LED chromaticity is measured and binned at 25°C ambient temperature with 1500 mA 20 ms single pulse.
- Luminus maintains a tolerance of  $\pm 0.005$  on Chromaticity (CIE<sub>x</sub>, CIE<sub>y</sub>) measurement.



## Absolute Maximum Ratings

		Symbol	Values	Unit
DC Forward Current	Minimum	$I_{f\ min}$	0.10	A
	Maximum	$I_{f\ max}$	3.75	
Surge Current (t<10 ms, Duty Cycle < 10%)		$I_s$	5	A
Reverse Voltage (@ $I_f = 10\ mA$ )		$V_r$	5	V
Power Dissipation		$P_D$	13	W
Junction Temperature		$T_{j\ max}$	150	°C
Operating Temperature		$T_{opr}$	-40 to 100	°C
Storage Temperature		$T_{stg}$	-40 to 100	°C
ESD withstand Voltage HBM Per ANSI/ESDA/JEDEC JS-001		$V_{HBM}$	8	kV
ESD withstand Voltage CDM Per ANSI/ESDA/JEDEC JS-002		$V_{CDM}$	1	kV

## Product Characteristics

Parameter		Symbol	Value		Unit
			WS	WE	
Color Rendering Index <sup>1</sup> ( $T_j = 85^\circ\text{C}$ )	Minimum	$CRI_{min}$	65	70	
	Typical	$CRI_{typ}$	70	-	
Viewing Angle (FWHM)		$2\theta_{1/2}$	120		°
Forward Voltage ( $I_f = 1500\ mA, T_j = 85^\circ\text{C}$ )	Minimum	$V_{f\ min}$	2.7		V
	Typical	$V_{f\ typ}$	3.0		
	Maximum	$V_{f\ max}$	3.3		
Temperature Coefficient of Voltage		$\partial V_f / \partial T$	-1.35		mV/°C
Thermal Resistance (Electrical) Junction/Solder Point		$R_{thjs-EL}$	1.2		°C/W

**Note:**

1. Luminus maintains a tolerance of  $\pm 2$  on Color Rendering Index (CRI) measurement.



### Relative Luminous Flux

Forward Current:  $\phi_v/\phi_v(1.5\text{ A}), T_j = 85^\circ\text{C}$

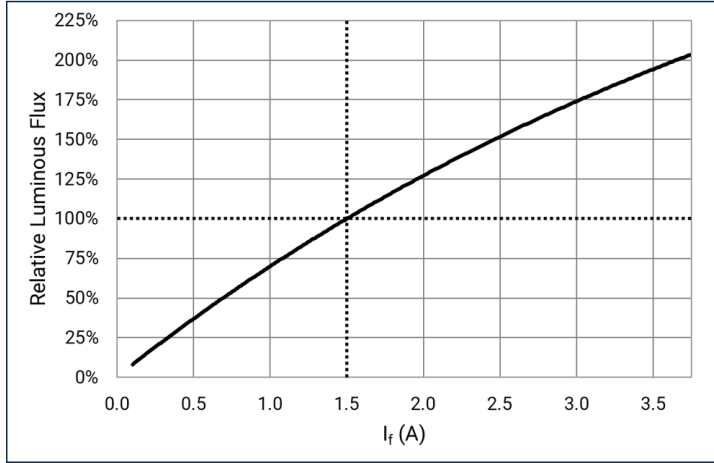

Temperature ( $T_j$ ):  $\phi_v/\phi_v(85^\circ\text{C}), I_f = 1.5\text{ A}$

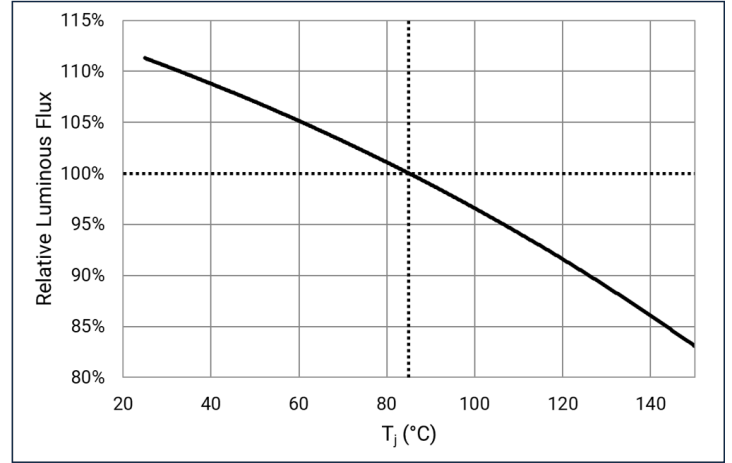

### Forward Voltage

Forward Current:  $\Delta V_f = V_f(I_f) - V_f(1.5\text{ A}), T_j = 85^\circ\text{C}$

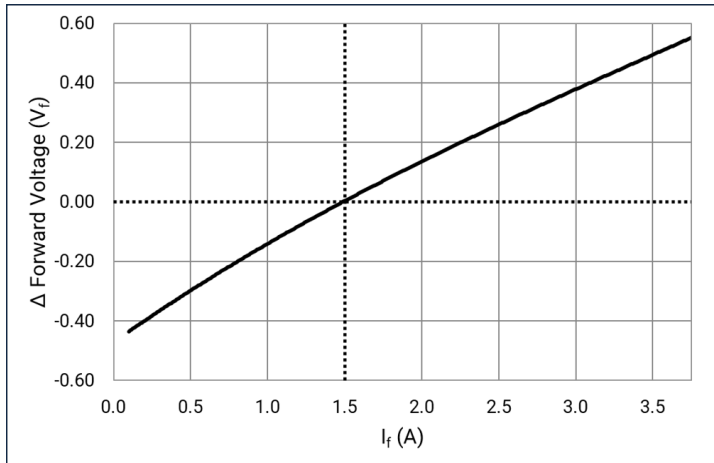

Temperature ( $T_j$ ):  $\Delta V_f = V_f(T_j) - V_f(85^\circ\text{C}), I_f = 1.5\text{ A}$

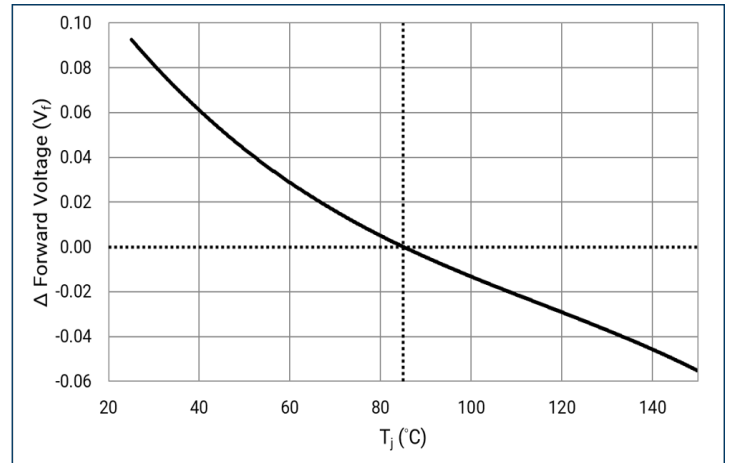

### Relative Chromaticity

Forward Current:  $\Delta \text{CIEx,y} = \text{CIEx,y}(I_f) - \text{CIEx,y}(1.5\text{ A}), T_j = 85^\circ\text{C}$

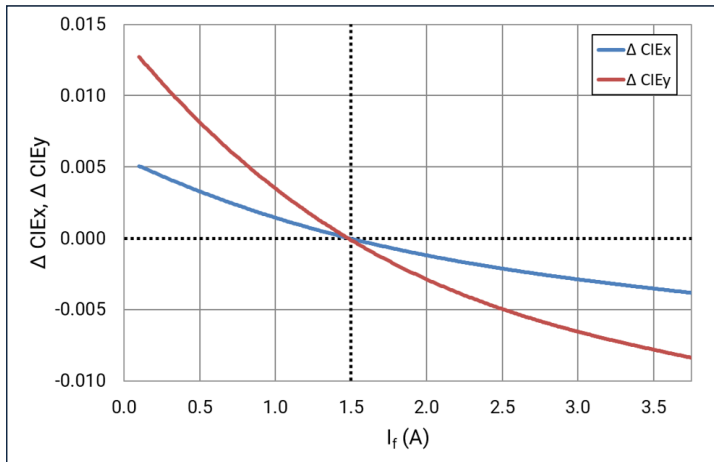

Temperature ( $T_j$ ):  $\Delta \text{CIEx,y} = \text{CIEx,y}(T_j) - \text{CIEx,y}(25^\circ\text{C}), I_f = 1.5\text{ A}$

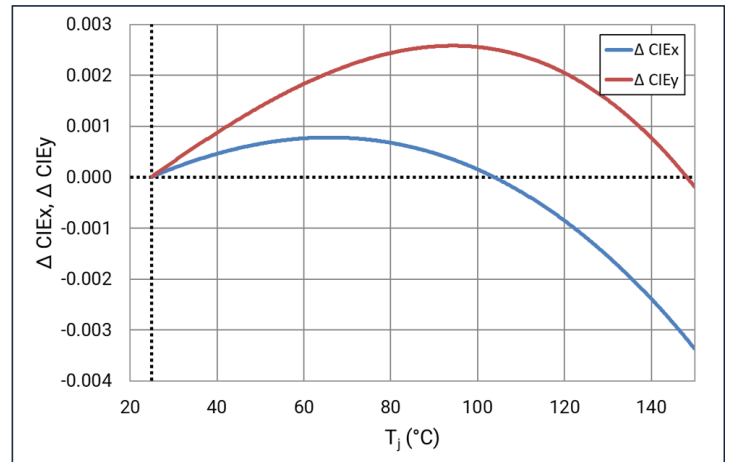





### Angular Distribution

$I_f = 1.5 \text{ A}; T_j = 25^\circ\text{C}$

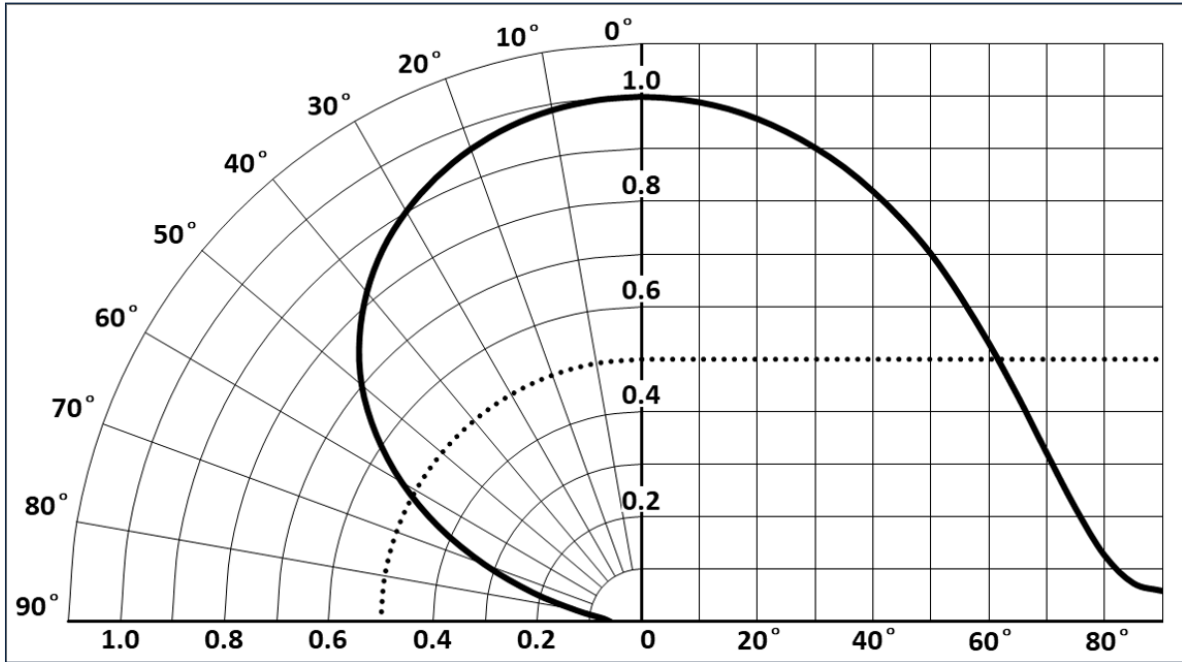

### Relative Spectral Power Distribution

$I_f = 1.5 \text{ A}; T_j = 85^\circ\text{C}$

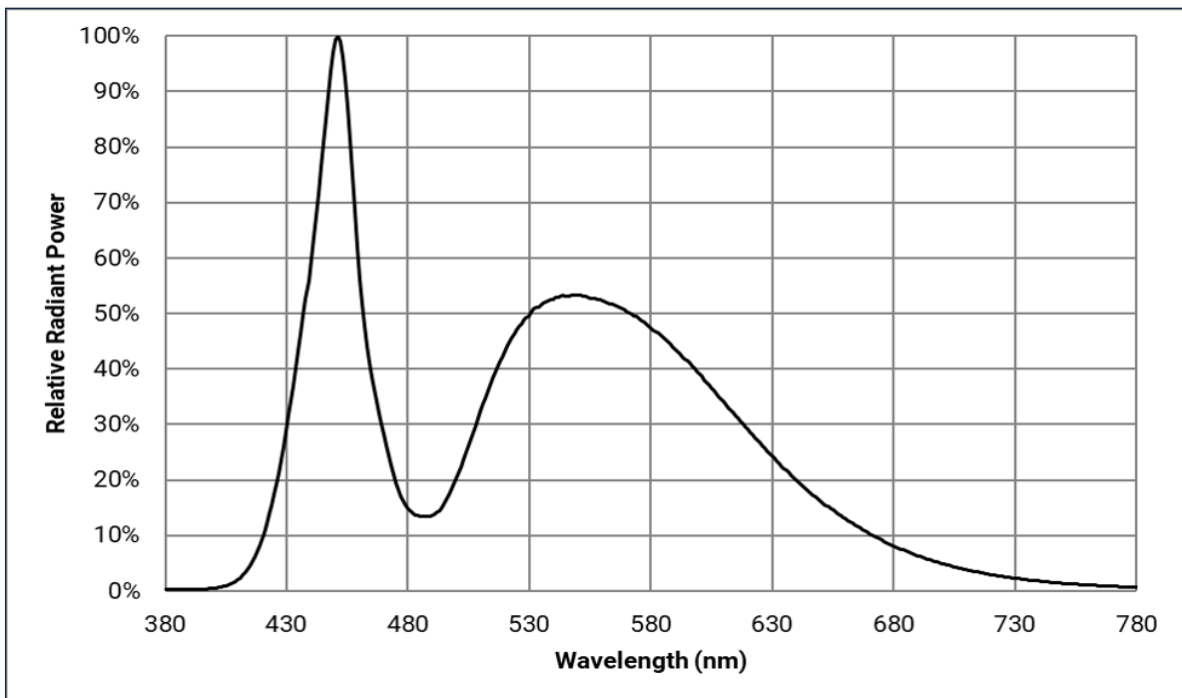



## Soldering Profile

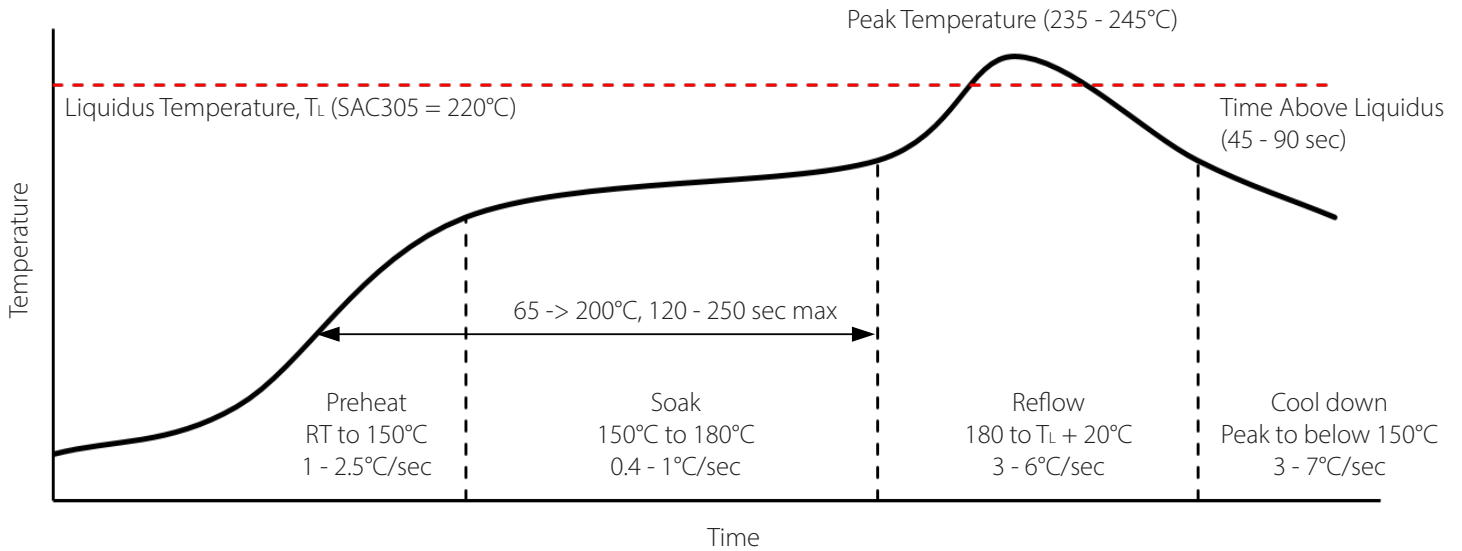

SMT Rework Guideline	Manual Hotplate Reflow	Hot Air Gun Reflow
Heating Time		< 60 sec
Hotplate Temperature	< 245°C	< 150°C

**Note:**

- Product complies to Moisture Sensitivity Level 3 (MSL 3).
- The numbers in the table are specific to SAC305. Luminus recommends using an SAC305 solder paste with a no-clean flux for RoHS compliant products.
- During the pick and place process, axial forces on the dome (or window) should not exceed 0.5 Newtons (N).
- Use of a multi-zone IR reflow oven with a nitrogen blanket is recommended.
- Time-temperature profile of the reflow process showing the four functional profile zones are defined in IPC-7801. Temperature is referenced to the center of the PCB.
- Luminus recommends to use the solder paste data sheet information as a starting point in time-temperature process development.
- These are general guidelines. Consult the solder paste manufacturer's datasheet for guidelines specific to the alloy and flux combination used in your application. For more information, please refer to:  
<https://luminusdevices.zendesk.com/hc/en-us/articles/360060306692-How-do-I-Reflow-Solder-Luminus-SMD-Components->
- For any technical questions about soldering process, please contact Luminus at techsupport@luminus.com.



## Mechanical Dimensions - Type A Solder Pad<sup>1</sup>

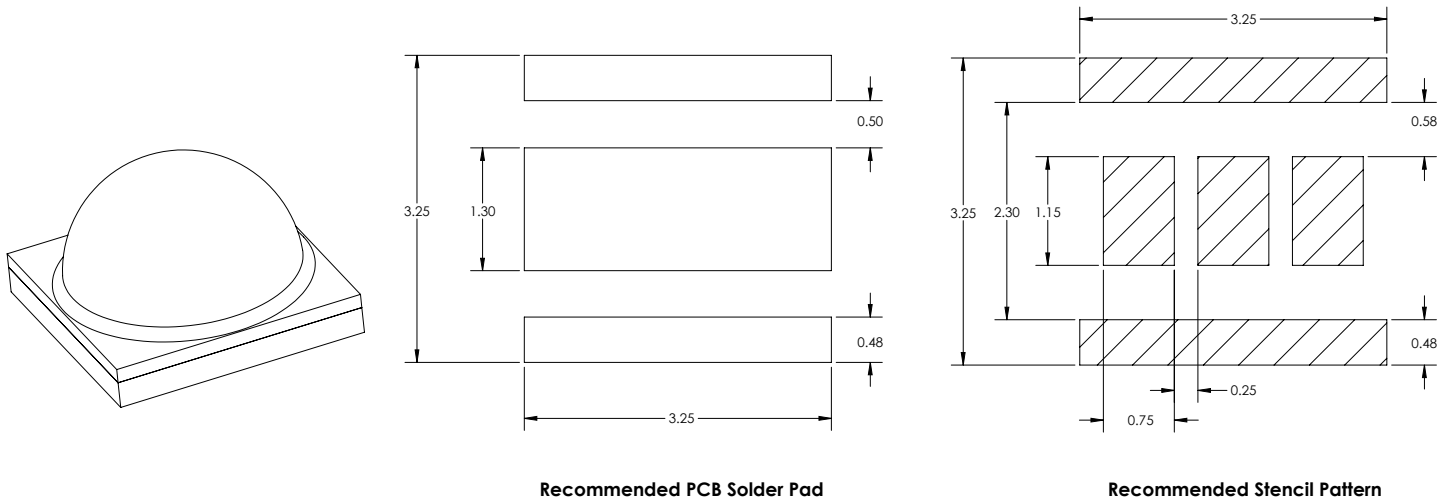
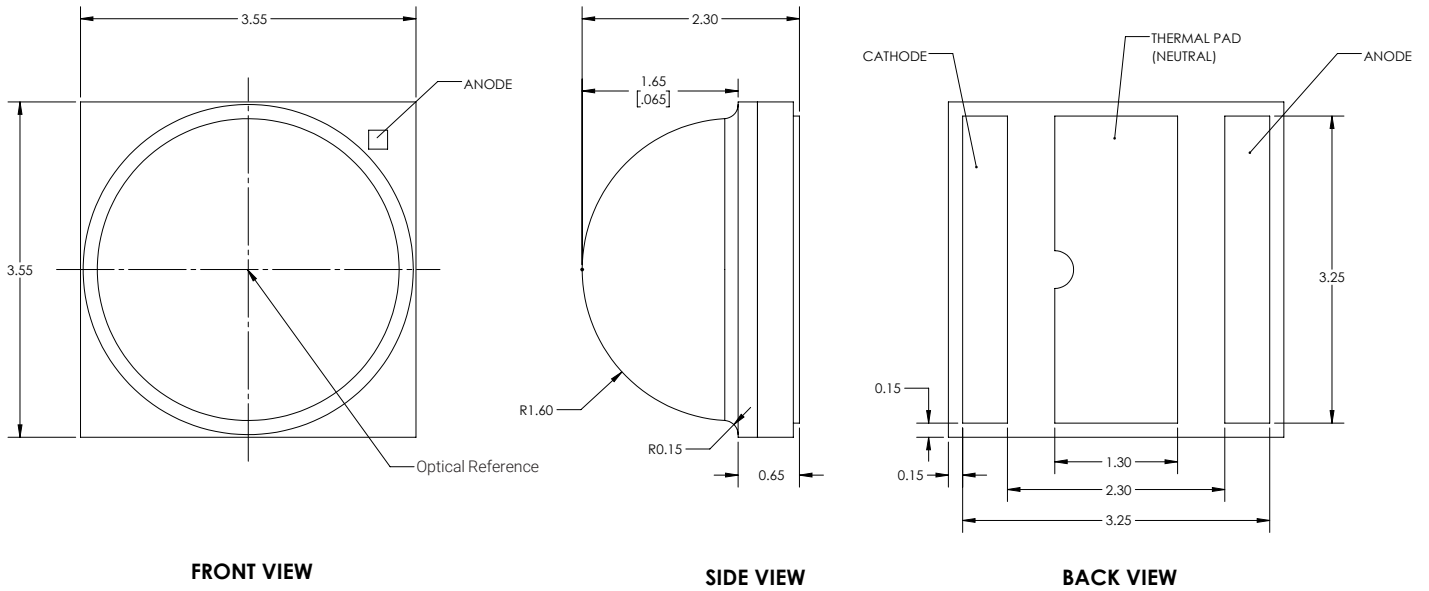

**Note:**

1. All dimensions are in millimeter  $\pm 0.13$  mm.



## Tape and Reel Outline

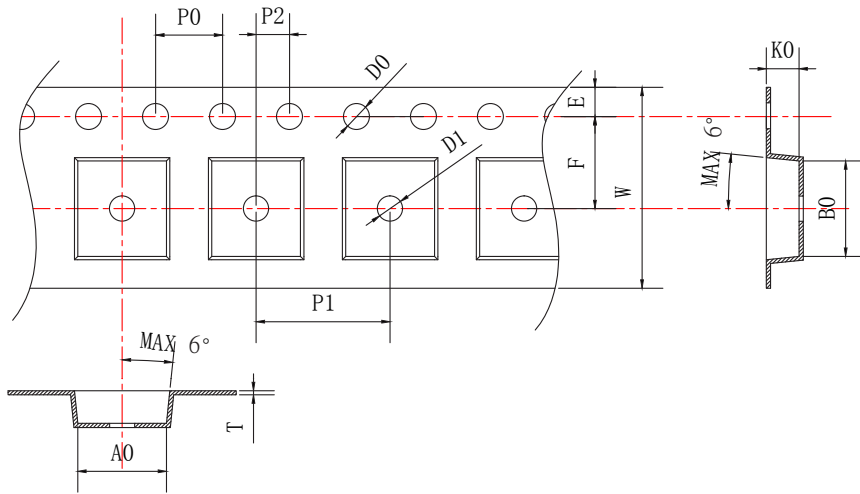

Parameter	Dimension (mm)
A0	3.7±0.1
B0	3.7±0.1
D0	1.5+1.0 1.5-0.0
D1	1.5±0.1
E1	1.75±0.1
F	5.5±0.1
K0	2.55±0.1
P0	4.0±0.1
P1	8.0±0.1
P2	2.0±0.1
T	0.3±0.05
W	12±0.3

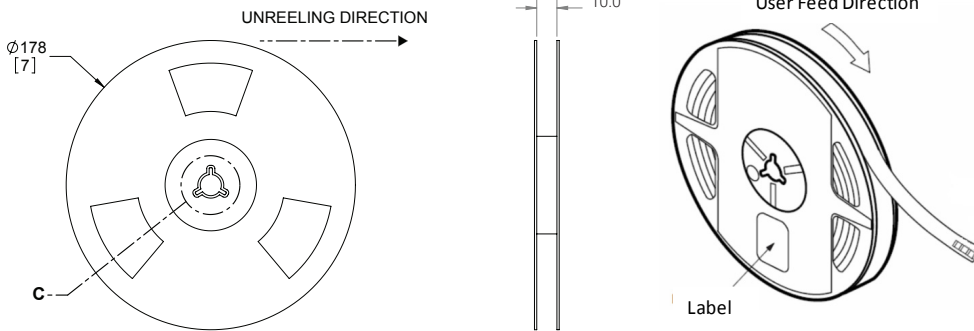

**Note:**

1. Each Reel contains 500 units of LEDs.
2. Black anti-static tape material (Denka ECMB/ECAP3)
3. The accumulated tolerance for ten chain holes should be no more than 0.2 mm.
4. The tortuosity of 250 mm tape should be no more than 1 mm.
5. Leave 800 mm of type empty for lead in (100 empty pockets)
6. Leave 1200 mm of type empty for the trailer (150 empty pockets)
7. All dimensions must comply to EIA-481-D
8. Final tape and reel packaging must meet the requirements of JEDEC -STD-033, LEVEL 2A.



## Shipping Label

### Label on Packaging Box

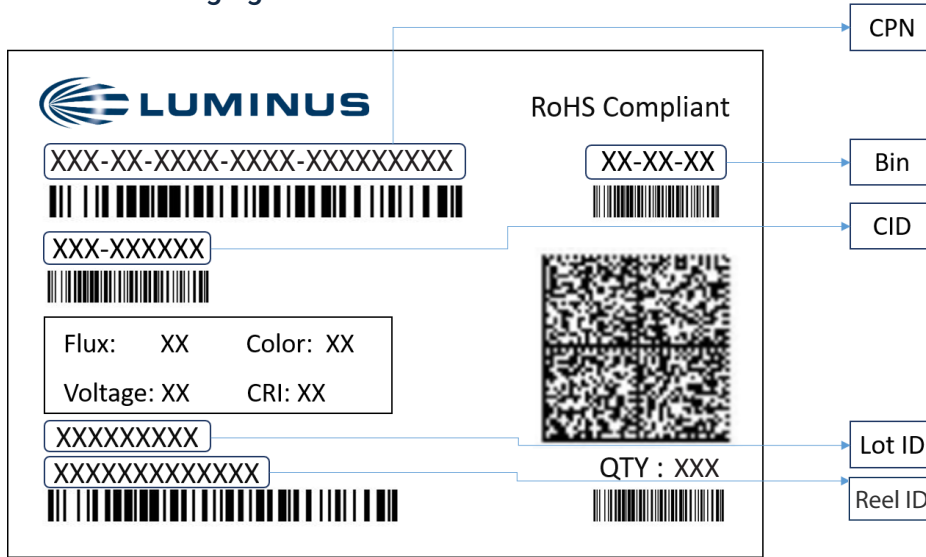

#### Label Fields:

- CPN: Luminus ordering part number
- CID: Customer's part number
- QTY: Quantity of parts per reel
- Flux: Bin as defined on page 4
- Voltage: Bin as defined on page 4
- Color: Bin as defined on page 5
- CRI: NA
- Lot ID & Reel ID: For Luminus internal use

### Label on Reel

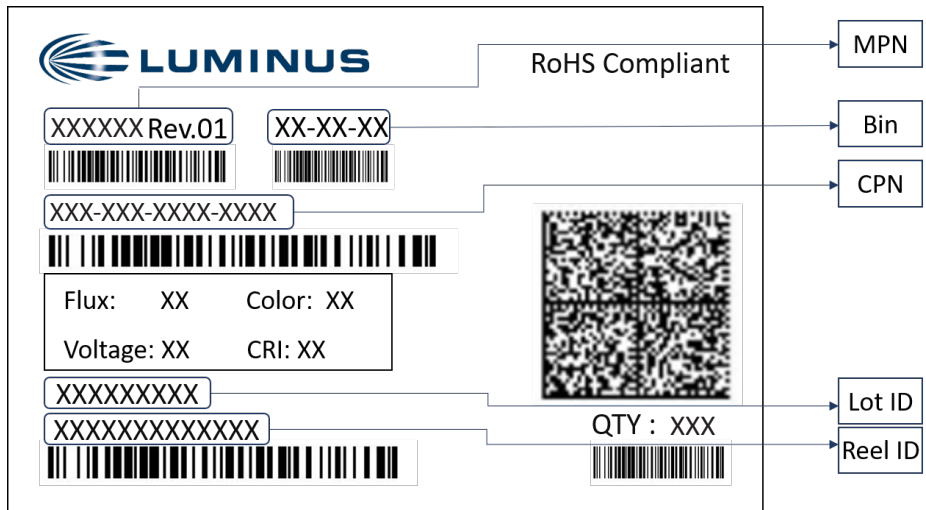

#### Label Fields:

- CPN: Luminus ordering part number
- MPN: For Luminus internal use
- QTY: Quantity of parts per reel
- Flux: Bin as defined on page 4
- Voltage: Bin as defined on page 4
- Color: Bin as defined on page 5
- CRI: NA
- Lot ID & Reel ID: For Luminus internal use



## Packaging

### Packaged Reel

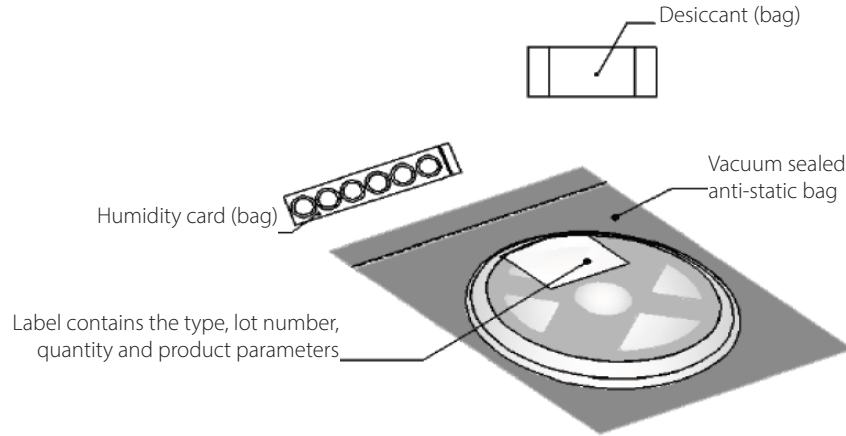

### Packaging boxes

**Box Size 1** - 5 reels per box  
Size: 22.5 x 24.5 x 6.5 cm

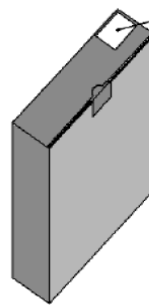
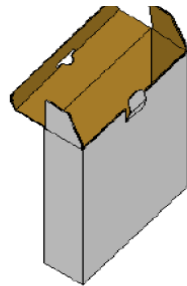

Label contains the type, lot number, quantity and product parameters

\*Capacity 5 reels per box

**Box Size 2** - 10 reels per box  
Size: 22.5 x 24.5 x 13 cm

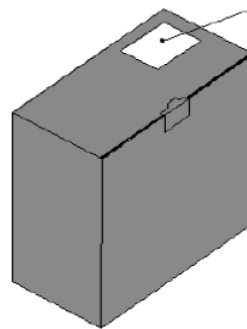
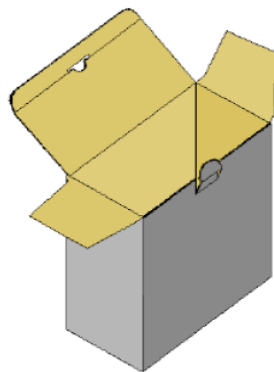

Label contains the type, lot number, quantity and product parameters

\*Capacity 10 reels per box

### Packing Configuration:

- 500 units per reel
- Each reel is enclosed in anti-static bag
- Shipping label is placed on top of each reel
- Multiple labels are attached to the box (one label per reel inside the box)



## Notes

### Static Electricity

1. The products are sensitive to static electricity, and care should be taken when handling them.
2. Static electricity or surge voltage will damage the LEDs. It is recommended to wear anti-electrostatic gloves or wristband when handling the LEDs.
3. All devices, equipment and machinery must be properly grounded. It is recommended that measures be taken against surge voltage to the equipment that mounts the LEDs.

Reference: [APN-002815](#) Electrical Stress Damage to LEDs and How to Prevent It

### Storage

1. Before opening the package

The LEDs should be kept at a temperature lower than 40°C and relative humidity lower than 90%. The LEDs should be used within a year. When storing the LEDs, moisture proof package with absorbent material (silica gel) is recommended.

2. After opening the package

The LEDs should be kept at a temperature lower than 30°C and relative humidity lower than 60%. The LEDs should be soldered within 168 hours (7 days) after opening the moisture proof package.

If unused LEDs remain, they should be stored in moisture proof packages, such as sealed containers with moisture absorbent material (silica gel). It is also recommended to return the unused LEDs to the original moisture proof package and to seal it again.

If the moisture absorbent material (silica gel) vaporizes or passes the expiration date, baking treatment should be performed by using the following conditions : 60°C for 20 hours.

The LED's electrode and lead frame comprise a silver plated copper alloy. The silver surface may be affected by environments. Please avoid conditions which may cause the LEDs to corrode or discolor. The corrosion or discoloration might lower solderability or affect optical characteristics.

Please avoid rapid transition in ambient temperature, especially in high humidity environments where condensation can occur.

# Mouser Electronics

Authorized Distributor

Click to View Pricing, Inventory, Delivery & Lifecycle Information:

[Luminus Devices:](#)

[SST-25-WE57-A2-G1572](#) [SST-25-WE50-A2-G1502](#) [SST-25-WS65-A2-G1652](#) [SST-25-WE57-A2-G2571](#) [SST-25-WE50-A2-G1501](#) [SST-25-WS65-A2-G2651](#) [SST-25-WS65-A2-G1651](#) [SST-25-WE50-A2-G2502](#) [SST-25-WS65-A2-G2652](#) [SST-25-WE57-A2-G2572](#) [SST-25-WE50-A2-G2501](#) [SST-25-WE57-A2-G1571](#)