

## XLamp® XHP50.3 LEDs

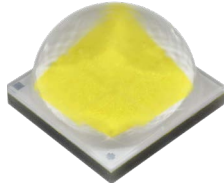

XHP50.3 High Density

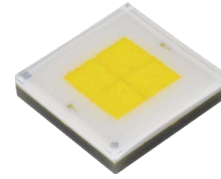

XHP50.3 High Intensity

### PRODUCT DESCRIPTION

The XLamp® XHP50.3 LEDs are the third generation of Extreme High Power LEDs that deliver the best lumen density, reliability and optical control available in their size. By leveraging the XHP family advantages, lighting manufacturers can significantly reduce their system cost by using fewer optics, PCBs and heat sinks than possible with standard LEDs.

The third generation XHP family LEDs deliver improved optical performance versus the previous generations, along with a new High Intensity version of the XHP50. The XHP50.3 High Intensity provides double the intensity for existing XHP50 designs.

XLamp XHP50.3 LEDs are optimized for outdoor and premium indoor lighting applications that require large amounts of light output from small luminaires, such as stadium, outdoor area and architectural spotlight.

### FEATURES

- Available in white, and in 3-V version or 6-V & 12-V version (6-V/12-V is configurable by PCB layout)
- Available in 5-step EasyWhite® bins at 3000 K to 5000 K CCT, 3-step EasyWhite bins at 2700 K to 5000 K and 2-step EasyWhite bins at 2700 K to 4000 K CCT
- Available in ANSI white bins at 3000 K to 7000 K CCT
- Available in standard, 70-, 80-, 90-, and 95-minimum CRI options
- Broadcast color option at 5700 K provides maximum performance for TV events that require extremely high TLCI
- Binned at 85 °C
- Maximum drive current: 6000 mA (3 V), 3000 mA (6 V), 1500 mA (12 V)
- Low thermal resistance: 0.4 °C/W
- Wide viewing angle: 120°
- Unlimited floor life at ≤ 30 °C/85% RH
- Reflow solderable - JEDEC J-STD-020C
- RoHS and REACH compliant
- UL® recognized component (E349212)



Cree LED / 4001 E. Hwy. 54, Suite 2000 / Durham, NC 27709 USA / +1.919.313.5330 / [www.cree-led.com](http://www.cree-led.com)

**TABLE OF CONTENTS**

|   |    |
|---|----|
| Characteristics .....   | 3  |
| High Density EasyWhite® Order Codes Suggested for New Designs (6-V/12-V) .....      | 4  |
| High Density ANSI Order Codes Suggested for New Designs (3-V) .....                 | 8  |
| High Density ANSI Order Codes Suggested for New Designs (6-V/12-V) .....            | 9  |
| High Density Broadcast Order Codes Suggested for New Designs (6-V/12-V) .....       | 13 |
| High Intensity EasyWhite® Order Codes Suggested for New Designs (6-V/12-V) .....    | 14 |
| High Intensity ANSI Order Codes Suggested for New Designs (3-V) .....               | 18 |
| High Intensity ANSI Order Codes Suggested for New Designs (6-V/12-V) .....          | 19 |
| High Intensity Broadcast Order Codes Suggested for New Designs (6-V/12-V) .....     | 22 |
| Relative Spectral Power Distribution .....  | 23 |
| Relative Flux vs. Junction Temperature.....   | 23 |
| Electrical Characteristics.....   | 24 |
| Relative Flux vs. Current.....  | 25 |
| Relative Chromaticity vs Current.....   | 27 |
| Relative Chromaticity vs Temperature.....   | 29 |
| Typical Spatial Distribution.....   | 30 |
| Thermal Design .....  | 31 |
| Performance Groups – Luminous Flux.....   | 32 |
| Performance Groups – Chromaticity.....  | 32 |
| EasyWhite® Chromaticity Regions Plotted on the 1931 CIE Curve.....                  | 35 |
| ANSI Cool White Kits Plotted on ANSI Standard Chromaticity Regions .....            | 36 |
| ANSI Warm and Neutral White Kits Plotted on ANSI Standard Chromaticity Regions..... | 37 |
| Bin and Order Code Formats.....   | 38 |
| Reflow Soldering Characteristics.....   | 39 |
| Notes .....   | 40 |
| Mechanical Dimensions .....   | 42 |
| Electrical Configuration .....  | 44 |
| Tape and Reel.....  | 45 |
| Packaging.....  | 48 |
| Appendix - Order Codes Not For New Designs .....                                    | 49 |

## CHARACTERISTICS

XHP50.3 LEDs are tested and binned in production in the 3-V and 12-V configurations. See the Mechanical Dimensions section on page 42 for pad layout options.

| Characteristics   | Unit    | Minimum | Typical  | Maximum |
|---|---------|---------|----------|---------|
| Thermal resistance, junction to solder point <sup>o</sup> | °C/W    |         | 0.4      |         |
| Viewing angle (FWHM)                                      | degrees |         | 120      |         |
| Temperature coefficient of voltage (3 V)                  | mV/°C   |         | -1.4     |         |
| Temperature coefficient of voltage (6 V)*                 | mV/°C   |         | -2.8     |         |
| Temperature coefficient of voltage (12 V)                 | mV/°C   |         | -5.6     |         |
| ESD withstand voltage (HBM per Mil-Std-883D)              |         |         | Class 3B |         |
| DC forward current (3 V)                                  | mA      |         |          | 6000    |
| DC forward current (6 V)*                                 | mA      |         |          | 3000    |
| DC forward current (12 V)                                 | mA      |         |          | 1500    |
| Reverse voltage (6V)                                      | V       |         |          | 1       |
| Forward voltage (3 V, @ 2800 mA, 85 °C)                   | V       |         | 2.8      | 3.1     |
| Forward voltage (6 V, @ 1400 mA, 85 °C)*                  | V       |         | 5.6      | 6.2     |
| Forward voltage (12 V, @ 700 mA, 85 °C)                   | V       |         | 11.2     | 12.4    |
| LED junction temperature                                  | °C      |         |          | 150     |

### Notes:

- ◊ Thermal resistance measurement was performed per the JEDEC JESD51-14 standard. See the [Thermal Resistance Measurement application note](#) for more details.
- \* Data for the 6-V configuration are calculated and for reference only.

**HIGH DENSITY EASYWHITE® ORDER CODES SUGGESTED FOR NEW DESIGNS (6-V/12-V)**

The following table provides order codes for XLamp XHP50.3 High Density LEDs. For a complete description of how the flux and chromaticity groups are reflected in the bin code and order code nomenclature, please see the Bin and Order Code Formats section (page 38).

Binning condition:  $T_j = 85\text{ °C}$ ; 12 V,  $I_f = 700\text{ mA}$   
 Reference condition:  $T_j = 85\text{ °C}$ ; 6 V,  $I_f = 1400\text{ mA}$

| Nominal CCT | CRI |     | Minimum Luminous Flux |                   |                    | 2-Step |            | 3-Step |                          | 5-Step |                          |
|-------------|-----|-----|-----------------------|-------------------|--------------------|--------|------------|--------|--------------------------|--------|--------------------------|
|             | Min | Typ | Group                 | Flux (lm) @ 85 °C | Flux (lm) @ 25 °C* | Group  | Order Code | Group  | Order Code               | Group  | Order Code               |
| 5000 K      | 70  |     | K2                    | 1200              | 1328               |        |            |        |                          | 50E    | XHP50D-00-0000-0D0BK250E |
|             |     |     | J4                    | 1120              | 1239               |        |            |        |                          |        | XHP50D-00-0000-0D0BJ450E |
|             |     |     | J2                    | 1040              | 1151               |        |            |        |                          |        | XHP50D-00-0000-0D0BJ250E |
|             | 80  |     | J4                    | 1120              | 1239               |        |            | 50G    | XHP50D-00-0000-0D0HJ450G |        |                          |
|             |     |     | J2                    | 1040              | 1151               |        |            |        | XHP50D-00-0000-0D0HJ250G |        |                          |
|             |     |     | H4                    | 970               | 1073               |        |            |        | XHP50D-00-0000-0D0HH450G |        |                          |
|             | 90  |     | H4                    | 970               | 1073               |        |            | 50G    | XHP50D-00-0000-0D0UH450G |        |                          |
|             |     |     | H2                    | 900               | 996                |        |            |        | XHP50D-00-0000-0D0UH250G |        |                          |
|             |     |     | G4                    | 840               | 930                |        |            |        | XHP50D-00-0000-0D0UG450G |        |                          |

**Notes**

- For additional order codes NOT recommended for new designs please see the Appendix section starting on page 49.
- Cree LED maintains a tolerance of  $\pm 7\%$  on flux and power measurements,  $\pm 0.005$  on chromaticity (CCx, CCy) measurements and a tolerance of  $\pm 2$  on CRI measurements. See the Measurements section (page 40).
- XLamp XHP50.3 LED order codes specify only a minimum flux bin and not a maximum. Cree LED may ship reels in flux bins higher than the minimum specified by the order code without advance notice. Shipments will always adhere to the chromaticity bin restrictions specified by the order code.
- \* Flux values @ 25 °C are calculated and for reference only.

HIGH DENSITY EASYWHITE® ORDER CODES SUGGESTED FOR NEW DESIGNS (6-V/12-V) - CONTINUED

| Nominal CCT | CRI |     | Minimum Luminous Flux |                   |                    | 2-Step                   |                           | 3-Step |                          | 5-Step |                          |
|-------------|-----|-----|-----------------------|-------------------|--------------------|--------------------------|---------------------------|--------|--------------------------|--------|--------------------------|
|             | Min | Typ | Group                 | Flux (lm) @ 85 °C | Flux (lm) @ 25 °C* | Group                    | Order Code                | Group  | Order Code               | Group  | Order Code               |
| 4500 K      | 70  |     | K2                    | 1200              | 1328               |                          |                           |        |                          | 45E    | XHP50D-00-0000-0D0BK245E |
|             |     |     | J4                    | 1120              | 1239               |                          | XHP50D-00-0000-0D0BJ445E  |        |                          |        |                          |
|             |     |     | J2                    | 1040              | 1151               |                          | XHP50D-00-0000-0D0BJ245E  |        |                          |        |                          |
|             | 80  |     | J4                    | 1120              | 1239               |                          |                           | 45G    | XHP50D-00-0000-0D0HJ445G |        |                          |
|             |     |     | J2                    | 1040              | 1151               |                          | XHP50D-00-0000-0D0HJ245G  |        |                          |        |                          |
|             |     |     | H4                    | 970               | 1073               |                          | XHP50D-00-0000-0D0HH5445G |        |                          |        |                          |
|             | 90  |     | H4                    | 970               | 1073               |                          |                           | 45G    | XHP50D-00-0000-0D0UH445G |        |                          |
|             |     |     | H2                    | 900               | 996                |                          | XHP50D-00-0000-0D0UH245G  |        |                          |        |                          |
|             |     |     | G4                    | 840               | 930                |                          | XHP50D-00-0000-0D0UG445G  |        |                          |        |                          |
| 4000 K      | 70  |     | K2                    | 1200              | 1328               |                          |                           |        |                          | 40E    | XHP50D-00-0000-0D0BK240E |
|             |     |     | J4                    | 1120              | 1239               |                          | XHP50D-00-0000-0D0BJ440E  |        |                          |        |                          |
|             |     |     | J2                    | 1040              | 1151               |                          | XHP50D-00-0000-0D0BJ240E  |        |                          |        |                          |
|             | 80  |     | J4                    | 1120              | 1239               | 40H                      | XHP50D-00-0000-0D0HJ440H  | 40G    | XHP50D-00-0000-0D0HJ440G |        |                          |
|             |     |     | J2                    | 1040              | 1151               | XHP50D-00-0000-0D0HJ240H | XHP50D-00-0000-0D0HJ240G  |        |                          |        |                          |
|             |     |     | H4                    | 970               | 1073               | XHP50D-00-0000-0D0HH440H | XHP50D-00-0000-0D0HH440G  |        |                          |        |                          |
|             | 90  |     | H4                    | 970               | 1073               | 40H                      | XHP50D-00-0000-0D0UH440H  | 40G    | XHP50D-00-0000-0D0UH440G |        |                          |
|             |     |     | H2                    | 900               | 996                | XHP50D-00-0000-0D0UH240H | XHP50D-00-0000-0D0UH240G  |        |                          |        |                          |
|             |     |     | G4                    | 840               | 930                | XHP50D-00-0000-0D0UG440H | XHP50D-00-0000-0D0UG440G  |        |                          |        |                          |

Notes

- For additional order codes NOT recommended for new designs please see the Appendix section starting on page 49.
- Cree LED maintains a tolerance of ±7% on flux and power measurements, ±0.005 on chromaticity (CCx, CCy) measurements and a tolerance of ±2 on CRI measurements. See the Measurements section (page 40).
- XLamp XHP50.3 LED order codes specify only a minimum flux bin and not a maximum. Cree LED may ship reels in flux bins higher than the minimum specified by the order code without advance notice. Shipments will always adhere to the chromaticity bin restrictions specified by the order code.
- \* Flux values @ 25 °C are calculated and for reference only.

HIGH DENSITY EASYWHITE® ORDER CODES SUGGESTED FOR NEW DESIGNS (6-V/12-V) - CONTINUED

| Nominal CCT | CRI |     | Minimum Luminous Flux |                   |                    | 2-Step |                          | 3-Step |                          | 5-Step |                          |
|-------------|-----|-----|-----------------------|-------------------|--------------------|--------|--------------------------|--------|--------------------------|--------|--------------------------|
|             | Min | Typ | Group                 | Flux (lm) @ 85 °C | Flux (lm) @ 25 °C* | Group  | Order Code               | Group  | Order Code               | Group  | Order Code               |
| 3500 K      | 70  |     | K2                    | 1200              | 1328               |        |                          |        |                          | 35E    | XHP50D-00-0000-0D0BK235E |
|             |     |     | J4                    | 1120              | 1239               |        |                          |        |                          |        | XHP50D-00-0000-0D0BJ435E |
|             |     |     | J2                    | 1040              | 1151               |        |                          |        |                          |        | XHP50D-00-0000-0D0BJ235E |
|             | 80  |     | J2                    | 1040              | 1151               | 35H    | XHP50D-00-0000-0D0HJ235H | 35G    | XHP50D-00-0000-0D0HJ235G |        |                          |
|             |     |     | H4                    | 970               | 1073               |        | XHP50D-00-0000-0D0HH435H |        | XHP50D-00-0000-0D0HH435G |        |                          |
|             |     |     | H2                    | 900               | 996                |        | XHP50D-00-0000-0D0HH235H |        | XHP50D-00-0000-0D0HH235G |        |                          |
|             | 90  |     | H2                    | 900               | 996                | 35H    | XHP50D-00-0000-0D0UH235H | 35G    | XHP50D-00-0000-0D0UH235G |        |                          |
|             |     |     | G4                    | 840               | 930                |        | XHP50D-00-0000-0D0UG435H |        | XHP50D-00-0000-0D0UG435G |        |                          |
|             |     |     | G2                    | 780               | 863                |        | XHP50D-00-0000-0D0UG235H |        | XHP50D-00-0000-0D0UG235G |        |                          |
| 3000 K      | 70  |     | J4                    | 1120              | 1239               |        |                          |        |                          | 30E    | XHP50D-00-0000-0D0BJ430E |
|             |     |     | J2                    | 1040              | 1151               |        |                          |        |                          |        | XHP50D-00-0000-0D0BJ230E |
|             |     |     | H4                    | 970               | 1073               |        |                          |        |                          |        | XHP50D-00-0000-0D0BH430E |
|             | 80  |     | J2                    | 1040              | 1151               | 30H    | XHP50D-00-0000-0D0HJ230H | 30G    | XHP50D-00-0000-0D0HJ230G |        |                          |
|             |     |     | H4                    | 970               | 1073               |        | XHP50D-00-0000-0D0HH430H |        | XHP50D-00-0000-0D0HH430G |        |                          |
|             |     |     | H2                    | 900               | 996                |        | XHP50D-00-0000-0D0HH230H |        | XHP50D-00-0000-0D0HH230G |        |                          |
|             | 90  |     | H2                    | 900               | 996                | 30H    | XHP50D-00-0000-0D0UH230H | 30G    | XHP50D-00-0000-0D0UH230G |        |                          |
|             |     |     | G4                    | 840               | 930                |        | XHP50D-00-0000-0D0UG430H |        | XHP50D-00-0000-0D0UG430G |        |                          |
|             |     |     | G2                    | 780               | 863                |        | XHP50D-00-0000-0D0UG230H |        | XHP50D-00-0000-0D0UG230G |        |                          |

Notes

- For additional order codes NOT recommended for new designs please see the Appendix section starting on page 49.
- Cree LED maintains a tolerance of ±7% on flux and power measurements, ±0.005 on chromaticity (CCx, CCy) measurements and a tolerance of ±2 on CRI measurements. See the Measurements section (page 40).
- XLamp XHP50.3 LED order codes specify only a minimum flux bin and not a maximum. Cree LED may ship reels in flux bins higher than the minimum specified by the order code without advance notice. Shipments will always adhere to the chromaticity bin restrictions specified by the order code.
- \* Flux values @ 25 °C are calculated and for reference only.

**HIGH DENSITY EASYWHITE® ORDER CODES SUGGESTED FOR NEW DESIGNS (6-V/12-V)- CONTINUED**

| Nominal CCT | CRI |     | Minimum Luminous Flux |                   |                    | 2-Step |                          | 3-Step |                          | 5-Step |            |
|-------------|-----|-----|-----------------------|-------------------|--------------------|--------|--------------------------|--------|--------------------------|--------|------------|
|             | Min | Typ | Group                 | Flux (lm) @ 85 °C | Flux (lm) @ 25 °C* | Group  | Order Code               | Group  | Order Code               | Group  | Order Code |
| 2700 K      | 80  |     | H4                    | 970               | 1073               | 27H    | XHP50D-00-0000-0D0HH427H | 27G    | XHP50D-00-0000-0D0HH427G |        |            |
|             |     |     | H2                    | 900               | 996                |        | XHP50D-00-0000-0D0HH227H |        | HP50D-00-0000-0D0HH227G  |        |            |
|             |     |     | G4                    | 840               | 930                |        | XHP50D-00-0000-0D0HG427H |        | XHP50D-00-0000-0D0HG427G |        |            |
|             | 90  |     | G4                    | 840               | 930                | 27H    | XHP50D-00-0000-0D0UG427H | 27G    | XHP50D-00-0000-0D0UG427G |        |            |
|             |     |     | G2                    | 780               | 863                |        | XHP50D-00-0000-0D0UG227H |        | XHP50D-00-0000-0D0UG227G |        |            |
|             |     |     | F4                    | 730               | 808                |        | XHP50D-00-0000-0D0UF427H |        | XHP50D-00-0000-0D0UF427G |        |            |

**Notes**

- For additional order codes NOT recommended for new designs please see the Appendix section starting on page 49.
- Cree LED maintains a tolerance of ±7% on flux and power measurements, ±0.005 on chromaticity (CCx, CCy) measurements and a tolerance of ±2 on CRI measurements. See the Measurements section (page 40).
- XLamp XHP50.3 LED order codes specify only a minimum flux bin and not a maximum. Cree LED may ship reels in flux bins higher than the minimum specified by the order code without advance notice. Shipments will always adhere to the chromaticity bin restrictions specified by the order code.
- \* Flux values @ 25 °C are calculated and for reference only.

### HIGH DENSITY ANSI ORDER CODES SUGGESTED FOR NEW DESIGNS (3-V)

The following table provides order codes for XLamp XHP50.3 High Density LEDs. For a complete description of how the flux and chromaticity groups are reflected in the bin code and order code nomenclature, please see the Bin and Order Code Formats section (page 38).

Binning condition:  $T_j = 85\text{ °C}$ ;  $3\text{ V}$ ,  $I_f = 2800\text{ mA}$

#### 3-V XHP50.3 LEDs

| Nominal CCT | Chromaticity Regions   | CRI |     | Minimum Luminous Flux |                              |                                | Order Code               |
|-------------|--|-----|-----|-----------------------|------------------------------|--------------------------------|--------------------------|
|             |  | Min | Typ | Group                 | Flux $I(m)$ @ $85\text{ °C}$ | Flux $I(m)$ @ $25\text{ °C}^*$ |                          |
| 7000 K      | 0A, 0B, 0C, 0D, 0R, 0S, 0T, 0U, 1A, 1B, 1C, 1D, 1R, 1S, 1T, 1U   | 0   | 68  | K2                    | 1200                         | 1328                           | XHP50D-00-0000-0A00K20DT |
|             |  |     |     | J4                    | 1120                         | 1239                           | XHP50D-00-0000-0A00J40DT |
| 6500 K      | 1A, 1B, 1C, 1D   | 0   | 68  | K2                    | 1200                         | 1328                           | XHP50D-00-0000-0A00K20E1 |
|             |  |     |     | J4                    | 1120                         | 1239                           | XHP50D-00-0000-0A00J40E1 |
| 6200 K      | 0A, 0B, 0C, 0D, 0R, 0S, 0T, 0U, 1A, 1B, 1C, 1D, 1R, 1S, 1T, 1U, 2A, 2B, 2C, 2D, 2R, 2S, 2T, 2U, 3A, 3B, 3R, 3S | 0   | 68  | K2                    | 1200                         | 1328                           | XHP50D-00-0000-0A00K20S1 |
|             |  |     |     | J4                    | 1120                         | 1239                           | XHP50D-00-0000-0A00J40S1 |
| 5700 K      | 2A, 2B, 2C, 2D   | 0   | 68  | K2                    | 1200                         | 1328                           | XHP50D-00-0000-0A00K20E2 |
|             |  |     |     | J4                    | 1120                         | 1239                           | XHP50D-00-0000-0A00J40E2 |
| 5000 K      | 3A, 3B, 3C, 3D   | 0   | 68  | K2                    | 1200                         | 1328                           | XHP50D-00-0000-0A00K20E3 |
|             |  |     |     | J4                    | 1120                         | 1239                           | XHP50D-00-0000-0A00J40E3 |

#### Notes

- For additional order codes NOT recommended for new designs please see the Appendix section starting on page 49.
- Cree LED maintains a tolerance of  $\pm 7\%$  on flux and power measurements,  $\pm 0.005$  on chromaticity (CCx, CCy) measurements and a tolerance of  $\pm 2$  on CRI measurements. See the Measurements section (page 40).
- XLamp XHP50.3 LED order codes specify only a minimum flux bin and not a maximum. Cree LED may ship reels in flux bins higher than the minimum specified by the order code without advance notice. Shipments will always adhere to the chromaticity bin restrictions specified by the order code.
- \* Flux values @  $25\text{ °C}$  are calculated and for reference only.



**HIGH DENSITY ANSI ORDER CODES SUGGESTED FOR NEW DESIGNS (6-V/12-V)**

Binning condition:  $T_j = 85\text{ °C}$ ; 12 V,  $I_f = 700\text{ mA}$

Reference condition:  $T_j = 85\text{ °C}$ ; 6 V,  $I_f = 1400\text{ mA}$

6-V & 12-V XHP50.3 LEDs

| Nominal CCT | Chromaticity Regions   | CRI |     | Minimum Luminous Flux |                     |                      | Order Code               |
|-------------|--|-----|-----|-----------------------|---------------------|----------------------|--------------------------|
|             |  | Min | Typ | Group                 | Flux $I(m)$ @ 85 °C | Flux $(lm)$ @ 25 °C* |                          |
| 7000 K      | 0A, 0B, 0C, 0D, 0R, 0S, 0T, 0U, 1A, 1B, 1C, 1D, 1R, 1S, 1T, 1U                                 | 0   | 68  | K2                    | 1200                | 1328                 | XHP50D-00-0000-0D00K20DT |
|             |  |     |     | J4                    | 1120                | 1239                 | XHP50D-00-0000-0D00J40DT |
|             |  |     |     | J2                    | 1040                | 1151                 | XHP50D-00-0000-0D00J20DT |
|             |  | 70  | 80  | K2                    | 1200                | 1328                 | XHP50D-00-0000-0D0BK20DT |
|             |  |     |     | J4                    | 1120                | 1239                 | XHP50D-00-0000-0D0BJ40DT |
|             |  |     |     | J2                    | 1040                | 1151                 | XHP50D-00-0000-0D0BJ20DT |
|             |  | 80  | 80  | J4                    | 1120                | 1239                 | XHP50D-00-0000-0D0HJ40DT |
|             |  |     |     | J2                    | 1040                | 1151                 | XHP50D-00-0000-0D0HJ20DT |
|             |  |     |     | H4                    | 970                 | 1073                 | XHP50D-00-0000-0D0HH40DT |
| 6500 K      | 0A, 0B, 0C, 0D, 0R, 0S, 0T, 0U, 1A, 1B, 1C, 1D, 1R, 1S, 1T, 1U, 2A, 2B, 2C, 2D, 2R, 2S, 2T, 2U | 0   | 68  | K2                    | 1200                | 1328                 | XHP50D-00-0000-0D00K20CB |
|             |  |     |     | J4                    | 1120                | 1239                 | XHP50D-00-0000-0D00J40CB |
|             |  |     |     | J2                    | 1040                | 1151                 | XHP50D-00-0000-0D00J20CB |
|             |  | 70  | 80  | K2                    | 1200                | 1328                 | XHP50D-00-0000-0D0BK20CB |
|             |  |     |     | J4                    | 1120                | 1239                 | XHP50D-00-0000-0D0BJ40CB |
|             |  |     |     | J2                    | 1040                | 1151                 | XHP50D-00-0000-0D0BJ20CB |
|             |  | 80  | 80  | J4                    | 1120                | 1239                 | XHP50D-00-0000-0D0HJ40CB |
|             |  |     |     | J2                    | 1040                | 1151                 | XHP50D-00-0000-0D0HJ20CB |
|             |  |     |     | H4                    | 970                 | 1073                 | XHP50D-00-0000-0D0HH40CB |
| 6500 K      | 1A, 1B, 1C, 1D   | 0   | 68  | K2                    | 1200                | 1328                 | XHP50D-00-0000-0D00K20E1 |
|             |  |     |     | J4                    | 1120                | 1239                 | XHP50D-00-0000-0D00J40E1 |
|             |  |     |     | J2                    | 1040                | 1151                 | XHP50D-00-0000-0D00J20E1 |
|             |  | 70  | 80  | K2                    | 1200                | 1328                 | XHP50D-00-0000-0D0BK20E1 |
|             |  |     |     | J4                    | 1120                | 1239                 | XHP50D-00-0000-0D0BJ40E1 |
|             |  |     |     | J2                    | 1040                | 1151                 | XHP50D-00-0000-0D0BJ20E1 |
|             |  | 80  | 80  | J4                    | 1120                | 1239                 | XHP50D-00-0000-0D0HJ40E1 |
|             |  |     |     | J2                    | 1040                | 1151                 | XHP50D-00-0000-0D0HJ20E1 |
|             |  |     |     | H4                    | 970                 | 1073                 | XHP50D-00-0000-0D0HH40E1 |

Notes

- For additional order codes NOT recommended for new designs please see the Appendix section starting on page 49.
- Cree LED maintains a tolerance of  $\pm 7\%$  on flux and power measurements,  $\pm 0.005$  on chromaticity (CCx, CCy) measurements and a tolerance of  $\pm 2$  on CRI measurements. See the Measurements section (page 40).
- XLamp XHP50.3 LED order codes specify only a minimum flux bin and not a maximum. Cree LED may ship reels in flux bins higher than the minimum specified by the order code without advance notice. Shipments will always adhere to the chromaticity bin restrictions specified by the order code.
- \* Flux values @ 25 °C are calculated and for reference only.

HIGH DENSITY ANSI ORDER CODES SUGGESTED FOR NEW DESIGNS (6-V/12-V) - CONTINUED

| Nominal CCT | Chromaticity Regions   | CRI |     | Minimum Luminous Flux |                   |                    | Order Code               |      |                          |
|-------------|--|-----|-----|-----------------------|-------------------|--------------------|--------------------------|------|--------------------------|
|             |  | Min | Typ | Group                 | Flux (lm) @ 85 °C | Flux (lm) @ 25 °C* |                          |      |                          |
| 6000 K      | 1A, 1B, 1C, 1D, 1R, 1S, 1T, 1U, 2A, 2B, 2C, 2D, 2R, 2S, 2T, 2U | 0   | 68  | K2                    | 1200              | 1328               | XHP50D-00-0000-0D00K20DV |      |                          |
|             |  |     |     | J4                    | 1120              | 1239               | XHP50D-00-0000-0D00J40DV |      |                          |
|             |  |     |     | J2                    | 1040              | 1151               | XHP50D-00-0000-0D00J20DV |      |                          |
|             |  | 70  |     |                       |                   | K2                 | 1200                     | 1328 | XHP50D-00-0000-0D0BK20DV |
|             |  |     |     |                       |                   | J4                 | 1120                     | 1239 | XHP50D-00-0000-0D0BJ40DV |
|             |  |     |     |                       |                   | J2                 | 1040                     | 1151 | XHP50D-00-0000-0D0BJ20DV |
|             |  | 80  |     |                       |                   | J4                 | 1120                     | 1239 | XHP50D-00-0000-0D0HJ40DV |
|             |  |     |     |                       |                   | J2                 | 1040                     | 1151 | XHP50D-00-0000-0D0HJ20DV |
|             |  |     |     |                       |                   | H4                 | 970                      | 1073 | XHP50D-00-0000-0D0HH40DV |
|             |  | 90  |     |                       |                   | H4                 | 970                      | 1073 | XHP50D-00-0000-0D0UH40DV |
|             |  |     |     |                       |                   | H2                 | 900                      | 996  | XHP50D-00-0000-0D0UH20DV |
|             |  |     |     |                       |                   | G4                 | 840                      | 930  | XHP50D-00-0000-0D0UG40DV |
| 5700 K      | 2A, 2B, 2C, 2D   | 0   | 68  | K2                    | 1200              | 1328               | XHP50D-00-0000-0D00K20E2 |      |                          |
|             |  |     |     | J4                    | 1120              | 1239               | XHP50D-00-0000-0D00J40E2 |      |                          |
|             |  |     |     | J2                    | 1040              | 1151               | XHP50D-00-0000-0D00J20E2 |      |                          |
|             |  | 70  |     |                       |                   | K2                 | 1200                     | 1328 | XHP50D-00-0000-0D0BK20E2 |
|             |  |     |     |                       |                   | J4                 | 1120                     | 1239 | XHP50D-00-0000-0D0BJ40E2 |
|             |  |     |     |                       |                   | J2                 | 1040                     | 1151 | XHP50D-00-0000-0D0BJ20E2 |
|             |  | 80  |     |                       |                   | J4                 | 1120                     | 1239 | XHP50D-00-0000-0D0HJ40E2 |
|             |  |     |     |                       |                   | J2                 | 1040                     | 1151 | XHP50D-00-0000-0D0HJ20E2 |
|             |  |     |     |                       |                   | H4                 | 970                      | 1073 | XHP50D-00-0000-0D0HH40E2 |
|             |  | 90  |     |                       |                   | H4                 | 970                      | 1073 | XHP50D-00-0000-0D0UH40E2 |
|             |  |     |     |                       |                   | H2                 | 900                      | 996  | XHP50D-00-0000-0D0UH20E2 |
|             |  |     |     |                       |                   | G4                 | 840                      | 930  | XHP50D-00-0000-0D0UG40E2 |

Notes

- For additional order codes NOT recommended for new designs please see the Appendix section starting on page 49.
- Cree LED maintains a tolerance of ±7% on flux and power measurements, ±0.005 on chromaticity (CCx, CCy) measurements and a tolerance of ±2 on CRI measurements. See the Measurements section (page 40).
- XLamp XHP50.3 LED order codes specify only a minimum flux bin and not a maximum. Cree LED may ship reels in flux bins higher than the minimum specified by the order code without advance notice. Shipments will always adhere to the chromaticity bin restrictions specified by the order code.
- \* Flux values @ 25 °C are calculated and for reference only.

HIGH DENSITY ANSI ORDER CODES SUGGESTED FOR NEW DESIGNS (6-V/12-V) - CONTINUED

| Nominal CCT | Chromaticity Regions | CRI |     | Minimum Luminous Flux |                   |                    | Order Code               |
|-------------|----------------------|-----|-----|-----------------------|-------------------|--------------------|--------------------------|
|             |                      | Min | Typ | Group                 | Flux l(m) @ 85 °C | Flux (lm) @ 25 °C* |                          |
| 5000 K      | 3A, 3B, 3C, 3D       | 0   | 68  | K2                    | 1200              | 1328               | XHP50D-00-0000-0D00K20E3 |
|             |                      |     |     | J4                    | 1120              | 1239               | XHP50D-00-0000-0D00J40E3 |
|             |                      |     |     | J2                    | 1040              | 1151               | XHP50D-00-0000-0D00J20E3 |
|             |                      | 70  |     | K2                    | 1200              | 1328               | XHP50D-00-0000-0D0BK20E3 |
|             |                      |     |     | J4                    | 1120              | 1239               | XHP50D-00-0000-0D0BJ40E3 |
|             |                      |     |     | J2                    | 1040              | 1151               | XHP50D-00-0000-0D0BJ20E3 |
|             |                      | 80  |     | J4                    | 1120              | 1239               | XHP50D-00-0000-0D0HJ40E3 |
|             |                      |     |     | J2                    | 1040              | 1151               | XHP50D-00-0000-0D0HJ20E3 |
|             |                      |     |     | H4                    | 970               | 1073               | XHP50D-00-0000-0D0HH40E3 |
|             |                      | 90  |     | H4                    | 970               | 1073               | XHP50D-00-0000-0D0UH40E3 |
|             |                      |     |     | H2                    | 900               | 996                | XHP50D-00-0000-0D0UH20E3 |
|             |                      |     |     | G4                    | 840               | 930                | XHP50D-00-0000-0D0UG40E3 |
| 4500 K      | 4A, 4B, 4C, 4D       | 0   | 68  | K2                    | 1200              | 1328               | XHP50D-00-0000-0D00K20E4 |
|             |                      |     |     | J4                    | 1120              | 1239               | XHP50D-00-0000-0D00J40E4 |
|             |                      |     |     | J2                    | 1040              | 1151               | XHP50D-00-0000-0D00J20E4 |
|             |                      | 70  |     | K2                    | 1200              | 1328               | XHP50D-00-0000-0D0BK20E4 |
|             |                      |     |     | J4                    | 1120              | 1239               | XHP50D-00-0000-0D0BJ40E4 |
|             |                      |     |     | J2                    | 1040              | 1151               | XHP50D-00-0000-0D0BJ20E4 |
|             |                      | 80  |     | J4                    | 1120              | 1239               | XHP50D-00-0000-0D0HJ40E4 |
|             |                      |     |     | J2                    | 1040              | 1151               | XHP50D-00-0000-0D0HJ20E4 |
|             |                      |     |     | H4                    | 970               | 1073               | XHP50D-00-0000-0D0HH40E4 |
|             |                      | 90  |     | H4                    | 970               | 1073               | XHP50D-00-0000-0D0UH40E4 |
|             |                      |     |     | H2                    | 900               | 996                | XHP50D-00-0000-0D0UH20E4 |
|             |                      |     |     | G4                    | 840               | 930                | XHP50D-00-0000-0D0UG40E4 |

Notes

- For additional order codes NOT recommended for new designs please see the Appendix section starting on page 49.
- Cree LED maintains a tolerance of ±7% on flux and power measurements, ±0.005 on chromaticity (CCx, CCy) measurements and a tolerance of ±2 on CRI measurements. See the Measurements section (page 40).
- XLamp XHP50.3 LED order codes specify only a minimum flux bin and not a maximum. Cree LED may ship reels in flux bins higher than the minimum specified by the order code without advance notice. Shipments will always adhere to the chromaticity bin restrictions specified by the order code.
- \* Flux values @ 25 °C are calculated and for reference only.

HIGH DENSITY ANSI ORDER CODES SUGGESTED FOR NEW DESIGNS (6-V/12-V) - CONTINUED

| Nominal CCT | Chromaticity Regions | CRI |     | Minimum Luminous Flux |                   |                    | Order Code               |
|-------------|----------------------|-----|-----|-----------------------|-------------------|--------------------|--------------------------|
|             |                      | Min | Typ | Group                 | Flux (lm) @ 85 °C | Flux (lm) @ 25 °C* |                          |
| 4000 K      | 5A, 5B, 5C, 5D       | 0   | 68  | K2                    | 1200              | 1328               | XHP50D-00-0000-0D00K20E5 |
|             |                      |     |     | J4                    | 1120              | 1239               | XHP50D-00-0000-0D00J40E5 |
|             |                      |     |     | J2                    | 1040              | 1151               | XHP50D-00-0000-0D00J20E5 |
|             |                      | 70  |     | K2                    | 1200              | 1328               | XHP50D-00-0000-0D0BK20E5 |
|             |                      |     |     | J4                    | 1120              | 1239               | XHP50D-00-0000-0D0BJ40E5 |
|             |                      |     |     | J2                    | 1040              | 1151               | XHP50D-00-0000-0D0BJ20E5 |
|             |                      | 80  |     | J4                    | 1120              | 1239               | XHP50D-00-0000-0D0HJ40E5 |
|             |                      |     |     | J2                    | 1040              | 1151               | XHP50D-00-0000-0D0HJ20E5 |
|             |                      |     |     | H4                    | 970               | 1073               | XHP50D-00-0000-0D0HH40E5 |
|             |                      | 90  |     | H4                    | 970               | 1073               | XHP50D-00-0000-0D0UH40E5 |
|             |                      |     |     | H2                    | 900               | 996                | XHP50D-00-0000-0D0UH20E5 |
|             |                      |     |     | G4                    | 840               | 930                | XHP50D-00-0000-0D0UG40E5 |
| 3500 K      | 6A, 6B, 6C, 6D       | 70  |     | K2                    | 1200              | 1328               | XHP50D-00-0000-0D0BK20E6 |
|             |                      |     |     | J4                    | 1120              | 1239               | XHP50D-00-0000-0D0BJ40E6 |
|             |                      |     |     | J2                    | 1040              | 1151               | XHP50D-00-0000-0D0BJ20E6 |
| 3000 K      | 7A, 7B, 7C, 7D       | 70  |     | J4                    | 1120              | 1239               | XHP50D-00-0000-0D0BJ40E7 |
|             |                      |     |     | J2                    | 1040              | 1151               | XHP50D-00-0000-0D0BJ20E7 |
|             |                      |     |     | H4                    | 970               | 1073               | XHP50D-00-0000-0D0BH40E7 |

Notes

- For additional order codes NOT recommended for new designs please see the Appendix section starting on page 49.
- Cree LED maintains a tolerance of ±7% on flux and power measurements, ±0.005 on chromaticity (CCx, CCy) measurements and a tolerance of ±2 on CRI measurements. See the Measurements section (page 40).
- XLamp XHP50.3 LED order codes specify only a minimum flux bin and not a maximum. Cree LED may ship reels in flux bins higher than the minimum specified by the order code without advance notice. Shipments will always adhere to the chromaticity bin restrictions specified by the order code.
- \* Flux values @ 25 °C are calculated and for reference only.

## HIGH DENSITY BROADCAST ORDER CODES SUGGESTED FOR NEW DESIGNS (6-V/12-V)

The following table provides order codes for XLamp XHP50.3 High Density Broadcast LEDs. For a complete description of how the flux and chromaticity groups are reflected in the bin code and order code nomenclature, please see the Bin and Order Code Formats section (page 38).

Binning condition:  $T_j = 85\text{ °C}$ ; 12 V,  $I_f = 700\text{ mA}$

Reference condition:  $T_j = 85\text{ °C}$ ; 6 V,  $I_f = 1400\text{ mA}$

### 6-V & 12-V XHP50.3 LEDs

| Chromaticity |        | Minimum Luminous Flux (lm)<br>@ 1050 mA |                      |                       | Order Codes                       |                                   |
|--------------|--------|---|----------------------|-----------------------|-----------------------------------|-----------------------------------|
| Kit          | CCT    | Flux Bin                                | Flux (lm)<br>@ 85 °C | Flux (lm)<br>@ 25 °C* | 90 CRI Minimum<br>90 TLCI Minimum | 95 CRI Minimum<br>95 TLCI Minimum |
| E2           | 5700 K | H2                                      | 900                  | 996                   | XHP50D-00-B001-AD0UH20E2          | XHP50D-00-B001-AD0ZG40E2          |
|              |        | G4                                      | 840                  | 930                   |                                   |                                   |

### Notes

- TLCI refers to the [European Broadcast Union's Television Lighting Consistency Index 2012](#), which aids broadcasters in assessing the colorimetric quality of lighting in their production environment. Cree LED maintains a tolerance of  $\pm 2$  on TLCI measurements. See the Measurements section (page 40).
- Cree LED maintains a tolerance of  $\pm 7\%$  on flux and power measurements,  $\pm 0.005$  on chromaticity (CCx, CCy) measurements and a tolerance of  $\pm 2$  on CRI. See the Measurements section (page 40).
- XLamp XHP50.3 LED order codes specify only a minimum flux bin and not a maximum. Cree LED may ship reels in flux bins higher than the minimum specified by the order code without advance notice. Shipments will always adhere to the chromaticity bin restrictions specified by the order code.
- \* Flux values @ 25 °C are calculated and for reference only.

**HIGH INTENSITY EASYWHITE® ORDER CODES SUGGESTED FOR NEW DESIGNS (6-V/12-V)**

The following table provides order codes for XLamp XHP50.3 High Intensity LEDs. For a complete description of how the flux and chromaticity groups are reflected in the bin code and order code nomenclature, please see the Bin and Order Code Formats section (page 38).

Binning condition:  $T_j = 85\text{ °C}$ ; 12 V,  $I_f = 700\text{ mA}$

Reference condition:  $T_j = 85\text{ °C}$ ; 6 V,  $I_f = 1400\text{ mA}$

| Nominal CCT | CRI |     | Minimum Luminous Flux |                   |                    | 2-Step |            | 3-Step |                          | 5-Step |                          |                          |
|-------------|-----|-----|-----------------------|-------------------|--------------------|--------|------------|--------|--------------------------|--------|--------------------------|--------------------------|
|             | Min | Typ | Group                 | Flux (lm) @ 85 °C | Flux (lm) @ 25 °C* | Group  | Order Code | Group  | Order Code               | Group  | Order Code               |                          |
| 5000 K      | 70  |     | J4                    | 1120              | 1239               |        |            |        |                          | 50E    | XHP50D-H0-0000-0D0BJ450E |                          |
|             |     |     | J2                    | 1040              | 1151               |        |            |        |                          |        | XHP50D-H0-0000-0D0BJ250E |                          |
|             |     |     | H4                    | 970               | 1073               |        |            |        |                          |        | XHP50D-H0-0000-0D0BH450E |                          |
|             | 80  |     | J2                    | 1040              | 1151               |        |            | 50G    | XHP50D-H0-0000-0D0HJ250G |        |                          | XHP50D-H0-0000-0D0HH450G |
|             |     |     | H4                    | 970               | 1073               |        |            |        | XHP50D-H0-0000-0D0HH250G |        |                          |                          |
|             |     |     | H2                    | 900               | 996                |        |            |        | XHP50D-H0-0000-0D0UH250G |        |                          |                          |
|             | 90  |     | H2                    | 900               | 996                |        |            | 50G    | XHP50D-H0-0000-0D0UH250G |        |                          | XHP50D-H0-0000-0D0UG450G |
|             |     |     | G4                    | 840               | 930                |        |            |        | XHP50D-H0-0000-0D0UG450G |        |                          |                          |
|             |     |     |                       |                   |                    |        |            |        |                          |        |                          |                          |
| 4500 K      | 70  |     | J4                    | 1120              | 1239               |        |            |        |                          | 45E    | XHP50D-H0-0000-0D0BJ445E |                          |
|             |     |     | J2                    | 1040              | 1151               |        |            |        |                          |        | XHP50D-H0-0000-0D0BJ245E |                          |
|             |     |     | H4                    | 970               | 1073               |        |            |        |                          |        | XHP50D-H0-0000-0D0BH445E |                          |
|             | 80  |     | J2                    | 1040              | 1151               |        |            | 45G    | XHP50D-H0-0000-0D0HJ245G |        |                          | XHP50D-H0-0000-0D0HH445G |
|             |     |     | H4                    | 970               | 1073               |        |            |        | XHP50D-H0-0000-0D0HH245G |        |                          |                          |
|             |     |     | H2                    | 900               | 996                |        |            |        | XHP50D-H0-0000-0D0UH245G |        |                          |                          |
|             | 90  |     | H2                    | 900               | 996                |        |            | 45G    | XHP50D-H0-0000-0D0UH245G |        |                          | XHP50D-H0-0000-0D0UG445G |
|             |     |     | G4                    | 840               | 930                |        |            |        | XHP50D-H0-0000-0D0UG445G |        |                          |                          |
|             |     |     |                       |                   |                    |        |            |        |                          |        |                          |                          |

**Notes**

- For additional order codes NOT recommended for new designs please see the Appendix section starting on page 49.
- Cree LED maintains a tolerance of  $\pm 7\%$  on flux and power measurements,  $\pm 0.005$  on chromaticity (CCx, CCy) measurements and a tolerance of  $\pm 2$  on CRI measurements. See the Measurements section (page 40).
- XLamp XHP50.3 LED order codes specify only a minimum flux bin and not a maximum. Cree LED may ship reels in flux bins higher than the minimum specified by the order code without advance notice. Shipments will always adhere to the chromaticity bin restrictions specified by the order code.
- \* Flux values @ 25 °C are calculated and for reference only.

**HIGH INTENSITY EASYWHITE® ORDER CODES SUGGESTED FOR NEW DESIGNS (6-V/12-V) - CONTINUED**

| Nominal CCT | CRI |     | Minimum Luminous Flux |                   |                    | 2-Step |                          | 3-Step |                          | 5-Step |                          |
|-------------|-----|-----|-----------------------|-------------------|--------------------|--------|--------------------------|--------|--------------------------|--------|--------------------------|
|             | Min | Typ | Group                 | Flux (lm) @ 85 °C | Flux (lm) @ 25 °C* | Group  | Order Code               | Group  | Order Code               | Group  | Order Code               |
| 4000 K      | 70  |     | J4                    | 1120              | 1239               |        |                          |        |                          | 40E    | XHP50D-H0-0000-0D0BJ440E |
|             |     |     | J2                    | 1040              | 1151               |        | XHP50D-H0-0000-0D0BJ240E |        |                          |        |                          |
|             |     |     | H4                    | 970               | 1073               |        | XHP50D-H0-0000-0D0BH440E |        |                          |        |                          |
|             | 80  |     | J2                    | 1040              | 1151               | 40H    | XHP50D-H0-0000-0D0HJ240H | 40G    | XHP50D-H0-0000-0D0HJ240G |        |                          |
|             |     |     | H4                    | 970               | 1073               |        | XHP50D-H0-0000-0D0HH440H |        | XHP50D-H0-0000-0D0HH440G |        |                          |
|             |     |     | H2                    | 900               | 996                |        | XHP50D-H0-0000-0D0HH240H |        | XHP50D-H0-0000-0D0HH240G |        |                          |
|             | 90  |     | H2                    | 900               | 996                | 40H    | XHP50D-H0-0000-0D0UH240H | 40G    | XHP50D-H0-0000-0D0UH240G |        |                          |
|             |     |     | G4                    | 840               | 930                |        | XHP50D-H0-0000-0D0UG440H |        | XHP50D-H0-0000-0D0UG440G |        |                          |
|             |     |     | G2                    | 780               | 863                |        | XHP50D-H0-0000-0D0UG240H |        | XHP50D-H0-0000-0D0UG240G |        |                          |
|             | 95  |     | G4                    | 840               | 930                | 40H    | XHP50D-H0-0000-0D0ZG440H | 40G    | XHP50D-H0-0000-0D0ZG440G |        |                          |
|             |     |     | G2                    | 780               | 863                |        | XHP50D-H0-0000-0D0ZG240H |        | XHP50D-H0-0000-0D0ZG240G |        |                          |
|             |     |     | F4                    | 730               | 808                |        | XHP50D-H0-0000-0D0ZF440H |        | XHP50D-H0-0000-0D0ZF440G |        |                          |

**Notes**

- For additional order codes NOT recommended for new designs please see the Appendix section starting on page 49.
- Cree LED maintains a tolerance of ±7% on flux and power measurements, ±0.005 on chromaticity (CCx, CCy) measurements and a tolerance of ±2 on CRI measurements. See the Measurements section (page 40).
- XLamp XHP50.3 LED order codes specify only a minimum flux bin and not a maximum. Cree LED may ship reels in flux bins higher than the minimum specified by the order code without advance notice. Shipments will always adhere to the chromaticity bin restrictions specified by the order code.
- \* Flux values @ 25 °C are calculated and for reference only.

HIGH INTENSITY EASYWHITE® ORDER CODES SUGGESTED FOR NEW DESIGNS (6-V/12-V) - CONTINUED

| Nominal CCT | CRI    |     | Minimum Luminous Flux |                   |                    | 2-Step |                          | 3-Step |                          | 5-Step                   |                          |                          |
|-------------|--------|-----|-----------------------|-------------------|--------------------|--------|--------------------------|--------|--------------------------|--------------------------|--------------------------|--------------------------|
|             | Min    | Typ | Group                 | Flux (lm) @ 85 °C | Flux (lm) @ 25 °C* | Group  | Order Code               | Group  | Order Code               | Group                    | Order Code               |                          |
| 3500 K      | 70     |     | J4                    | 1120              | 1239               |        |                          |        |                          | 35E                      | XHP50D-H0-0000-0D0BJ435E |                          |
|             |        |     | J2                    | 1040              | 1151               |        |                          |        |                          |                          | XHP50D-H0-0000-0D0BJ235E |                          |
|             |        |     | H4                    | 970               | 1073               |        |                          |        |                          |                          | XHP50D-H0-0000-0D0BH435E |                          |
|             | 80     |     | H4                    | 970               | 1073               |        | XHP50D-H0-0000-0D0HH435H |        | XHP50D-H0-0000-0D0HH435G |                          |                          |                          |
|             |        |     | H2                    | 900               | 996                | 35H    | XHP50D-H0-0000-0D0HH235H | 35G    | XHP50D-H0-0000-0D0HH235G |                          |                          |                          |
|             |        |     | G4                    | 840               | 930                |        | XHP50D-H0-0000-0D0HG435H |        | XHP50D-H0-0000-0D0HG435G |                          |                          |                          |
|             | 90     |     | G4                    | 840               | 930                |        | XHP50D-H0-0000-0D0UG435H |        | XHP50D-H0-0000-0D0UG435G |                          |                          |                          |
|             |        |     | G2                    | 780               | 863                | 35H    | XHP50D-H0-0000-0D0UG235H | 35G    | XHP50D-H0-0000-0D0UG235G |                          |                          |                          |
|             |        |     | F4                    | 730               | 808                |        | XHP50D-H0-0000-0D0UF435H |        | XHP50D-H0-0000-0D0UF435G |                          |                          |                          |
|             | 95     |     | F4                    | 730               | 808                |        | XHP50D-H0-0000-0D0ZF435H |        | XHP50D-H0-0000-0D0ZF435G |                          |                          |                          |
|             |        |     | F2                    | 680               | 753                | 35H    | XHP50D-H0-0000-0D0ZF235H | 35G    | XHP50D-H0-0000-0D0ZF235G |                          |                          |                          |
|             | 3000 K | 70  |                       | J2                | 1040               | 1151   |                          |        |                          |                          | 30E                      | XHP50D-H0-0000-0D0BJ230E |
|             |        |     | H4                    | 970               | 1073               |        |                          |        |                          | XHP50D-H0-0000-0D0BH430E |                          |                          |
|             |        |     | H2                    | 900               | 996                |        |                          |        |                          | XHP50D-H0-0000-0D0BH230E |                          |                          |
| 80          |        |     | H4                    | 970               | 1073               |        | XHP50D-H0-0000-0D0HH430H |        | XHP50D-H0-0000-0D0HH430G |                          |                          |                          |
|             |        |     | H2                    | 900               | 996                | 30H    | XHP50D-H0-0000-0D0HH230H | 30G    | XHP50D-H0-0000-0D0HH230G |                          |                          |                          |
|             |        |     | G4                    | 840               | 930                |        | XHP50D-H0-0000-0D0HG430H |        | XHP50D-H0-0000-0D0HG430G |                          |                          |                          |
| 90          |        |     | G4                    | 840               | 930                |        | XHP50D-H0-0000-0D0UG430H |        | XHP50D-H0-0000-0D0UG430G |                          |                          |                          |
|             |        |     | G2                    | 780               | 863                | 30H    | XHP50D-H0-0000-0D0UG230H | 30G    | XHP50D-H0-0000-0D0UG230G |                          |                          |                          |
|             |        |     | F4                    | 730               | 808                |        | XHP50D-H0-0000-0D0UF430H |        | XHP50D-H0-0000-0D0UF430G |                          |                          |                          |
| 95          |        |     | F4                    | 730               | 808                |        | XHP50D-H0-0000-0D0ZF430H |        | XHP50D-H0-0000-0D0ZF430G |                          |                          |                          |
|             |        |     | F2                    | 680               | 753                | 30H    | XHP50D-H0-0000-0D0ZF230H | 3G     | XHP50D-H0-0000-0D0ZF230G |                          |                          |                          |

Notes

- For additional order codes NOT recommended for new designs please see the Appendix section starting on page 49.
- Cree LED maintains a tolerance of ±7% on flux and power measurements, ±0.005 on chromaticity (CCx, CCy) measurements and a tolerance of ±2 on CRI measurements. See the Measurements section (page 40).
- XLamp XHP50.3 LED order codes specify only a minimum flux bin and not a maximum. Cree LED may ship reels in flux bins higher than the minimum specified by the order code without advance notice. Shipments will always adhere to the chromaticity bin restrictions specified by the order code.
- \* Flux values @ 25 °C are calculated and for reference only.



HIGH INTENSITY ANSI ORDER CODES SUGGESTED FOR NEW DESIGNS (6-V/12-V) - CONTINUED

| Nominal CCT | CRI |     | Minimum Luminous Flux |                   |                    | 2-Step |                          | 3-Step |                          | 5-Step |            |
|-------------|-----|-----|-----------------------|-------------------|--------------------|--------|--------------------------|--------|--------------------------|--------|------------|
|             | Min | Typ | Group                 | Flux (lm) @ 85 °C | Flux (lm) @ 25 °C* | Group  | Order Code               | Group  | Order Code               | Group  | Order Code |
| 2700 K      | 80  |     | H4                    | 970               | 1073               | 27H    | XHP50D-H0-0000-0D0HH427H | 27G    | XHP50D-H0-0000-0D0HH427G |        |            |
|             |     |     | H2                    | 900               | 996                |        | XHP50D-H0-0000-0D0HH227H |        | HP50D-H0-0000-0D0HH227G  |        |            |
|             |     |     | G4                    | 840               | 930                |        | XHP50D-H0-0000-0D0HG427H |        | XHP50D-H0-0000-0D0HG427G |        |            |
|             | 90  |     | G2                    | 780               | 863                | 27H    | XHP50D-H0-0000-0D0UG227H | 27G    | XHP50D-H0-0000-0D0UG227G |        |            |
|             |     |     | F4                    | 730               | 808                |        | XHP50D-H0-0000-0D0UF427H |        | XHP50D-H0-0000-0D0UF427G |        |            |
|             |     |     | F2                    | 680               | 753                |        | XHP50D-H0-0000-0D0UF227H |        | XHP50D-H0-0000-0D0UF227G |        |            |
|             | 95  |     | F4                    | 730               | 808                | 27H    | XHP50D-H0-0000-0D0ZF427H | 27G    | XHP50D-H0-0000-0D0ZF427G |        |            |
|             |     |     | F2                    | 680               | 753                |        | XHP50D-H0-0000-0D0ZF227H |        | XHP50D-H0-0000-0D0ZF227G |        |            |
|             |     |     | E4                    | 635               | 703                |        | XHP50D-H0-0000-0D0ZE427H |        | XHP50D-H0-0000-0D0ZE427G |        |            |

Notes

- For additional order codes NOT recommended for new designs please see the Appendix section starting on page 49.
- Cree LED maintains a tolerance of ±7% on flux and power measurements, ±0.005 on chromaticity (CCx, CCy) measurements and a tolerance of ±2 on CRI measurements. See the Measurements section (page 40).
- XLamp XHP50.3 LED order codes specify only a minimum flux bin and not a maximum. Cree LED may ship reels in flux bins higher than the minimum specified by the order code without advance notice. Shipments will always adhere to the chromaticity bin restrictions specified by the order code.
- \* Flux values @ 25 °C are calculated and for reference only.

### HIGH INTENSITY ANSI ORDER CODES SUGGESTED FOR NEW DESIGNS (3-V)

The following table provides order codes for XLamp XHP50.3 High Intensity LEDs. For a complete description of how the flux and chromaticity groups are reflected in the bin code and order code nomenclature, please see the Bin and Order Code Formats section (page 38).

Binning condition:  $T_j = 85\text{ °C}$ ; 12 V,  $I_f = 700\text{ mA}$   
 Reference condition:  $T_j = 85\text{ °C}$ ; 6 V,  $I_f = 1400\text{ mA}$   
 Binning condition:  $T_j = 85\text{ °C}$ ; 3 V,  $I_f = 2800\text{ mA}$

#### 3-V XHP50.3 LEDs

| Nominal CCT | Chromaticity Regions   | CRI |     | Minimum Luminous Flux |                   |                    | Order Code               |
|-------------|--|-----|-----|-----------------------|-------------------|--------------------|--------------------------|
|             |  | Min | Typ | Group                 | Flux (lm) @ 85 °C | Flux (lm) @ 25 °C* |                          |
| 7000 K      | 0A, 0B, 0C, 0D, 0R, 0S, 0T, 0U, 1A, 1B, 1C, 1D, 1R, 1S, 1T, 1U   | 0   | 68  | J4                    | 1120              | 1239               | XHP50D-H0-0000-0A00J40DT |
|             |  |     |     | J2                    | 1040              | 1151               | XHP50D-H0-0000-0A00J20DT |
| 6500 K      | 1A, 1B, 1C, 1D   | 0   | 68  | J4                    | 1120              | 1239               | XHP50D-H0-0000-0A00J40E1 |
|             |  |     |     | J2                    | 1040              | 1151               | XHP50D-H0-0000-0A00J20E1 |
| 6200 K      | 0A, 0B, 0C, 0D, 0R, 0S, 0T, 0U, 1A, 1B, 1C, 1D, 1R, 1S, 1T, 1U, 2A, 2B, 2C, 2D, 2R, 2S, 2T, 2U, 3A, 3B, 3R, 3S | 0   | 68  | J4                    | 1120              | 1239               | XHP50D-H0-0000-0A00J40S1 |
|             |  |     |     | J2                    | 1040              | 1151               | XHP50D-H0-0000-0A00J20S1 |
| 5700 K      | 2A, 2B, 2C, 2D   | 0   | 68  | J4                    | 1120              | 1239               | XHP50D-H0-0000-0A00J40E2 |
|             |  |     |     | J2                    | 1040              | 1151               | XHP50D-H0-0000-0A00J20E2 |
| 5000 K      | 3A, 3B, 3C, 3D   | 0   | 68  | J4                    | 1120              | 1239               | XHP50D-H0-0000-0A00J40E3 |
|             |  |     |     | J2                    | 1040              | 1151               | XHP50D-H0-0000-0A00J20E3 |

#### Notes

- For additional order codes NOT recommended for new designs please see the Appendix section starting on page 49.
- Cree LED maintains a tolerance of  $\pm 7\%$  on flux and power measurements,  $\pm 0.005$  on chromaticity (CCx, CCy) measurements and a tolerance of  $\pm 2$  on CRI measurements. See the Measurements section (page 40).
- XLamp XHP50.3 LED order codes specify only a minimum flux bin and not a maximum. Cree LED may ship reels in flux bins higher than the minimum specified by the order code without advance notice. Shipments will always adhere to the chromaticity bin restrictions specified by the order code.
- \* Flux values @ 25 °C are calculated and for reference only.

**HIGH INTENSITY ANSI ORDER CODES SUGGESTED FOR NEW DESIGNS (6-V/12-V)**

Binning condition:  $T_j = 85\text{ }^\circ\text{C}$ ; 12 V,  $I_f = 700\text{ mA}$

Reference condition:  $T_j = 85\text{ }^\circ\text{C}$ ; 6 V,  $I_f = 1400\text{ mA}$

6-V & 12-V XHP50.3 LEDs

| Nominal CCT | Chromaticity Regions   | CRI |     | Minimum Luminous Flux |                     |                      | Order Code               |                           |
|-------------|--|-----|-----|-----------------------|---------------------|----------------------|--------------------------|---------------------------|
|             |  | Min | Typ | Group                 | Flux $I(m)$ @ 85 °C | Flux $(lm)$ @ 25 °C* |                          |                           |
| 7000 K      | 0A, 0B, 0C, 0D, 0R, 0S, 0T, 0U, 1A, 1B, 1C, 1D, 1R, 1S, 1T, 1U                                 | 0   | 68  | J4                    | 1120                | 1239                 | XHP50D-H0-0000-0D00J40DT |                           |
|             |  |     |     | J2                    | 1040                | 1151                 | XHP50D-H0-0000-0D00J20DT |                           |
|             |  |     |     | H4                    | 970                 | 1073                 | XHP50D-H0-0000-0D00H40DT |                           |
|             |  | 70  | 70  | J4                    | 1120                | 1239                 | 1239                     | XHP50D-H0-0000-0D00BJ40DT |
|             |  |     |     | J2                    | 1040                | 1151                 | 1151                     | XHP50D-H0-0000-0D00BJ20DT |
|             |  |     |     | H4                    | 970                 | 1073                 | 1073                     | XHP50D-H0-0000-0D00BH40DT |
|             |  | 80  | 80  | J2                    | 1040                | 1151                 | 1151                     | XHP50D-H0-0000-0D00HJ20DT |
|             |  |     |     | H4                    | 970                 | 1073                 | 1073                     | XHP50D-H0-0000-0D00HH40DT |
|             |  |     |     | H2                    | 900                 | 996                  | 996                      | XHP50D-H0-0000-0D00HH20DT |
| 6500 K      | 0A, 0B, 0C, 0D, 0R, 0S, 0T, 0U, 1A, 1B, 1C, 1D, 1R, 1S, 1T, 1U, 2A, 2B, 2C, 2D, 2R, 2S, 2T, 2U | 0   | 68  | J4                    | 1120                | 1239                 | XHP50D-H0-0000-0D00J40CB |                           |
|             |  |     |     | J2                    | 1040                | 1151                 | XHP50D-H0-0000-0D00J20CB |                           |
|             |  |     |     | H4                    | 970                 | 1073                 | XHP50D-H0-0000-0D00H40CB |                           |
|             |  | 70  | 70  | J4                    | 1120                | 1239                 | 1239                     | XHP50D-H0-0000-0D00BJ40CB |
|             |  |     |     | J2                    | 1040                | 1151                 | 1151                     | XHP50D-H0-0000-0D00BJ20CB |
|             |  |     |     | H4                    | 970                 | 1073                 | 1073                     | XHP50D-H0-0000-0D00BH40CB |
|             |  | 80  | 80  | J2                    | 1040                | 1151                 | 1151                     | XHP50D-H0-0000-0D00HJ20CB |
|             |  |     |     | H4                    | 970                 | 1073                 | 1073                     | XHP50D-H0-0000-0D00HH40CB |
|             |  |     |     | H2                    | 900                 | 996                  | 996                      | XHP50D-H0-0000-0D00HH20CB |
| 6500 K      | 1A, 1B, 1C, 1D   | 0   | 68  | J4                    | 1120                | 1239                 | XHP50D-H0-0000-0D00J40E1 |                           |
|             |  |     |     | J2                    | 1040                | 1151                 | XHP50D-H0-0000-0D00J20E1 |                           |
|             |  |     |     | H4                    | 970                 | 1073                 | XHP50D-H0-0000-0D00H40E1 |                           |
|             |  | 70  | 70  | J4                    | 1120                | 1239                 | 1239                     | XHP50D-H0-0000-0D00BJ40E1 |
|             |  |     |     | J2                    | 1040                | 1151                 | 1151                     | XHP50D-H0-0000-0D00BJ20E1 |
|             |  |     |     | H4                    | 970                 | 1073                 | 1073                     | XHP50D-H0-0000-0D00BH40E1 |
|             |  | 80  | 80  | J2                    | 1040                | 1151                 | 1151                     | XHP50D-H0-0000-0D00HJ20E1 |
|             |  |     |     | H4                    | 970                 | 1073                 | 1073                     | XHP50D-H0-0000-0D00HH40E1 |
|             |  |     |     | H2                    | 900                 | 996                  | 996                      | XHP50D-H0-0000-0D00HH20E1 |

Notes

- For additional order codes NOT recommended for new designs please see the Appendix section starting on page 49.
- Cree LED maintains a tolerance of  $\pm 7\%$  on flux and power measurements,  $\pm 0.005$  on chromaticity (CCx, CCy) measurements and a tolerance of  $\pm 2$  on CRI measurements. See the Measurements section (page 40).
- XLamp XHP50.3 LED order codes specify only a minimum flux bin and not a maximum. Cree LED may ship reels in flux bins higher than the minimum specified by the order code without advance notice. Shipments will always adhere to the chromaticity bin restrictions specified by the order code.
- \* Flux values @ 25 °C are calculated and for reference only.

HIGH INTENSITY ANSI ORDER CODES SUGGESTED FOR NEW DESIGNS (6-V/12-V) - CONTINUED

| Nominal CCT | Chromaticity Regions   | CRI    |                | Minimum Luminous Flux |                   |                    | Order Code               |      |                          |
|-------------|--|--------|----------------|-----------------------|-------------------|--------------------|--------------------------|------|--------------------------|
|             |  | Min    | Typ            | Group                 | Flux l(m) @ 85 °C | Flux (lm) @ 25 °C* |                          |      |                          |
| 6000 K      | 1A, 1B, 1C, 1D, 1R, 1S, 1T, 1U, 2A, 2B, 2C, 2D, 2R, 2S, 2T, 2U | 0      | 68             | J4                    | 1120              | 1239               | XHP50D-H0-0000-0D00J40DV |      |                          |
|             |  |        |                | J2                    | 1040              | 1151               | XHP50D-H0-0000-0D00J20DV |      |                          |
|             |  |        |                | H4                    | 970               | 1073               | XHP50D-H0-0000-0D00H40DV |      |                          |
|             |  | 70     |                |                       |                   | J4                 | 1120                     | 1239 | XHP50D-H0-0000-0D0BJ40DV |
|             |  |        |                |                       |                   | J2                 | 1040                     | 1151 | XHP50D-H0-0000-0D0BJ20DV |
|             |  |        |                |                       |                   | H4                 | 970                      | 1073 | XHP50D-H0-0000-0D0BH40DV |
|             |  | 80     |                |                       |                   | J2                 | 1040                     | 1151 | XHP50D-H0-0000-0D0HJ20DV |
|             |  |        |                |                       |                   | H4                 | 970                      | 1073 | XHP50D-H0-0000-0D0HH40DV |
|             |  |        |                |                       |                   | H2                 | 900                      | 996  | XHP50D-H0-0000-0D0HH20DV |
|             |  | 90     |                |                       |                   | H2                 | 900                      | 996  | XHP50D-H0-0000-0D0UH20DV |
|             |  |        |                |                       |                   | G4                 | 840                      | 930  | XHP50D-H0-0000-0D0UG40DV |
|             |  | 5700 K | 2A, 2B, 2C, 2D | 0                     | 68                | J4                 | 1120                     | 1239 | XHP50D-H0-0000-0D00J40E2 |
| J2          | 1040   |        |                |                       |                   | 1151               | XHP50D-H0-0000-0D00J20E2 |      |                          |
| H4          | 970  |        |                |                       |                   | 1073               | XHP50D-H0-0000-0D00H40E2 |      |                          |
| 70          |  |        |                |                       |                   | J4                 | 1120                     | 1239 | XHP50D-H0-0000-0D0BJ40E2 |
|             |  |        |                |                       |                   | J2                 | 1040                     | 1151 | XHP50D-H0-0000-0D0BJ20E2 |
|             |  |        |                |                       |                   | H4                 | 970                      | 1073 | XHP50D-H0-0000-0D0BH40E2 |
| 80          |  |        |                |                       |                   | J2                 | 1040                     | 1151 | XHP50D-H0-0000-0D0HJ20E2 |
|             |  |        |                |                       |                   | H4                 | 970                      | 1073 | XHP50D-H0-0000-0D0HH40E2 |
|             |  |        |                |                       |                   | H2                 | 900                      | 996  | XHP50D-H0-0000-0D0HH20E2 |
| 90          |  |        |                |                       |                   | H2                 | 900                      | 996  | XHP50D-H0-0000-0D0UH20E2 |
|             |  |        |                |                       |                   | G4                 | 840                      | 930  | XHP50D-H0-0000-0D0UG40E2 |
| 5000 K      | 3A, 3B, 3C, 3D   |        |                | 0                     | 68                | J4                 | 1120                     | 1239 | XHP50D-H0-0000-0D00J40E3 |
|             |  | J2     | 1040           |                       |                   | 1151               | XHP50D-H0-0000-0D00J20E3 |      |                          |
|             |  | H4     | 970            |                       |                   | 1073               | XHP50D-H0-0000-0D00H40E3 |      |                          |
|             |  | 70     |                |                       |                   | J4                 | 1120                     | 1239 | XHP50D-H0-0000-0D0BJ40E3 |
|             |  |        |                |                       |                   | J2                 | 1040                     | 1151 | XHP50D-H0-0000-0D0BJ20E3 |
|             |  |        |                |                       |                   | H4                 | 970                      | 1073 | XHP50D-H0-0000-0D0BH40E3 |
|             |  | 80     |                |                       |                   | J2                 | 1040                     | 1151 | XHP50D-H0-0000-0D0HJ20E3 |
|             |  |        |                |                       |                   | H4                 | 970                      | 1073 | XHP50D-H0-0000-0D0HH40E3 |
|             |  |        |                |                       |                   | H2                 | 900                      | 996  | XHP50D-H0-0000-0D0HH20E3 |
|             |  | 90     |                |                       |                   | H2                 | 900                      | 996  | XHP50D-H0-0000-0D0UH20E3 |
|             |  |        |                |                       |                   | G4                 | 840                      | 930  | XHP50D-H0-0000-0D0UG40E3 |

Notes

- For additional order codes NOT recommended for new designs please see the Appendix section starting on page 49.
- Cree LED maintains a tolerance of ±7% on flux and power measurements, ±0.005 on chromaticity (CCx, CCy) measurements and a tolerance of ±2 on CRI measurements. See the Measurements section (page 40).
- XLamp XHP50.3 LED order codes specify only a minimum flux bin and not a maximum. Cree LED may ship reels in flux bins higher than the minimum specified by the order code without advance notice. Shipments will always adhere to the chromaticity bin restrictions specified by the order code.
- \* Flux values @ 25 °C are calculated and for reference only.

HIGH INTENSITY ANSI ORDER CODES SUGGESTED FOR NEW DESIGNS (6-V/12-V) - CONTINUED

| Nominal CCT | Chromaticity Regions | CRI    |                | Minimum Luminous Flux |                   |                    | Order Code               |
|-------------|----------------------|--------|----------------|-----------------------|-------------------|--------------------|--------------------------|
|             |                      | Min    | Typ            | Group                 | Flux l(m) @ 85 °C | Flux (lm) @ 25 °C* |                          |
| 4500 K      | 4A, 4B, 4C, 4D       | 0      | 68             | J4                    | 1120              | 1239               | XHP50D-H0-0000-0D00J40E4 |
|             |                      |        |                | J2                    | 1040              | 1151               | XHP50D-H0-0000-0D00J20E4 |
|             |                      |        |                | H4                    | 970               | 1073               | XHP50D-H0-0000-0D00H40E4 |
|             |                      | 70     |                | J4                    | 1120              | 1239               | XHP50D-H0-0000-0D0BJ40E4 |
|             |                      |        |                | J2                    | 1040              | 1151               | XHP50D-H0-0000-0D0BJ20E4 |
|             |                      |        |                | H4                    | 970               | 1073               | XHP50D-H0-0000-0D0BH40E4 |
|             |                      | 80     |                | J2                    | 1040              | 1151               | XHP50D-H0-0000-0D0HJ20E4 |
|             |                      |        |                | H4                    | 970               | 1073               | XHP50D-H0-0000-0D0HH40E4 |
|             |                      |        |                | H2                    | 900               | 996                | XHP50D-H0-0000-0D0HH20E4 |
|             |                      | 90     |                | H2                    | 900               | 996                | XHP50D-H0-0000-0D0UH20E4 |
|             |                      |        |                | G4                    | 840               | 930                | XHP50D-H0-0000-0D0UG40E4 |
|             |                      | 4000 K | 5A, 5B, 5C, 5D | 0                     | 68                | J4                 | 1120                     |
| J2          | 1040                 |        |                |                       |                   | 1151               | XHP50D-H0-0000-0D00J20E5 |
| H4          | 970                  |        |                |                       |                   | 1073               | XHP50D-H0-0000-0D00H40E5 |
| 70          |                      |        |                | J4                    | 1120              | 1239               | XHP50D-H0-0000-0D0BJ40E5 |
|             |                      |        |                | J2                    | 1040              | 1151               | XHP50D-H0-0000-0D0BJ20E5 |
|             |                      |        |                | H4                    | 970               | 1073               | XHP50D-H0-0000-0D0BH40E5 |
| 80          |                      |        |                | J2                    | 1040              | 1151               | XHP50D-H0-0000-0D0HJ20E5 |
|             |                      |        |                | H4                    | 970               | 1073               | XHP50D-H0-0000-0D0HH40E5 |
|             |                      |        |                | H2                    | 900               | 996                | XHP50D-H0-0000-0D0HH20E5 |
| 90          |                      |        |                | H2                    | 900               | 996                | XHP50D-H0-0000-0D0UH20E5 |
|             |                      |        |                | G4                    | 840               | 930                | XHP50D-H0-0000-0D0UG40E5 |
|             |                      |        |                | G2                    | 780               | 863                | XHP50D-H0-0000-0D0UG20E5 |
| 3500 K      | 6A, 6B, 6C, 6D       | 70     |                | J4                    | 1120              | 1239               | XHP50D-H0-0000-0D0BJ40E6 |
|             |                      |        |                | J2                    | 1040              | 1151               | XHP50D-H0-0000-0D0BJ20E6 |
|             |                      |        |                | H4                    | 970               | 1073               | XHP50D-H0-0000-0D0BH40E6 |
| 3000 K      | 7A, 7B, 7C, 7D       | 70     |                | J2                    | 1040              | 1151               | XHP50D-H0-0000-0D0BJ20E7 |
|             |                      |        |                | H4                    | 970               | 1073               | XHP50D-H0-0000-0D0BH40E7 |
|             |                      |        |                | H2                    | 900               | 996                | XHP50D-H0-0000-0D0BH20E7 |

Notes

- For additional order codes NOT recommended for new designs please see the Appendix section starting on page 49.
- Cree LED maintains a tolerance of ±7% on flux and power measurements, ±0.005 on chromaticity (CCx, CCy) measurements and a tolerance of ±2 on CRI measurements. See the Measurements section (page 40).
- XLamp XHP50.3 LED order codes specify only a minimum flux bin and not a maximum. Cree LED may ship reels in flux bins higher than the minimum specified by the order code without advance notice. Shipments will always adhere to the chromaticity bin restrictions specified by the order code.
- \* Flux values @ 25 °C are calculated and for reference only.

## HIGH INTENSITY BROADCAST ORDER CODES SUGGESTED FOR NEW DESIGNS (6-V/12-V)

The following table provides order codes for XLamp XHP50.3 High Intensity Broadcast LEDs. For a complete description of how the flux and chromaticity groups are reflected in the bin code and order code nomenclature, please see the Bin and Order Code Formats section (page 38).

Binning condition:  $T_j = 85\text{ °C}$ ; 12 V,  $I_f = 700\text{ mA}$

Reference condition:  $T_j = 85\text{ °C}$ ; 6 V,  $I_f = 1400\text{ mA}$

### 6-V & 12-V XHP50.3 LEDs

| Chromaticity |        | Minimum Luminous Flux (lm)<br>@ 1050 mA |                      |                       | Order Codes                       |                                   |
|--------------|--------|---|----------------------|-----------------------|-----------------------------------|-----------------------------------|
| Kit          | CCT    | Flux Bin                                | Flux (lm)<br>@ 85 °C | Flux (lm)<br>@ 25 °C* | 90 CRI Minimum<br>90 TLCI Minimum | 95 CRI Minimum<br>95 TLCI Minimum |
| E2           | 5700 K | G4                                      | 840                  | 930                   | XHP50D-H0-B001-AD0UG40E2          | XHP50D-H0-B001-AD0ZG20E2          |
|              |        | G2                                      | 780                  | 863                   |                                   |                                   |

### Notes

- TLCI refers to the [European Broadcast Union's Television Lighting Consistency Index 2012](#), which aids broadcasters in assessing the colorimetric quality of lighting in their production environment. Cree LED maintains a tolerance of  $\pm 2$  on TLCI measurements. See the Measurements section (page 40).
- Cree LED maintains a tolerance of  $\pm 7\%$  on flux and power measurements,  $\pm 0.005$  on chromaticity (CCx, CCy) measurements and a tolerance of  $\pm 2$  on CRI. See the Measurements section (page 40).
- XLamp XHP50.3 LED order codes specify only a minimum flux bin and not a maximum. Cree LED may ship reels in flux bins higher than the minimum specified by the order code without advance notice. Shipments will always adhere to the chromaticity bin restrictions specified by the order code.
- \* Flux values @ 25 °C are calculated and for reference only.

RELATIVE SPECTRAL POWER DISTRIBUTION

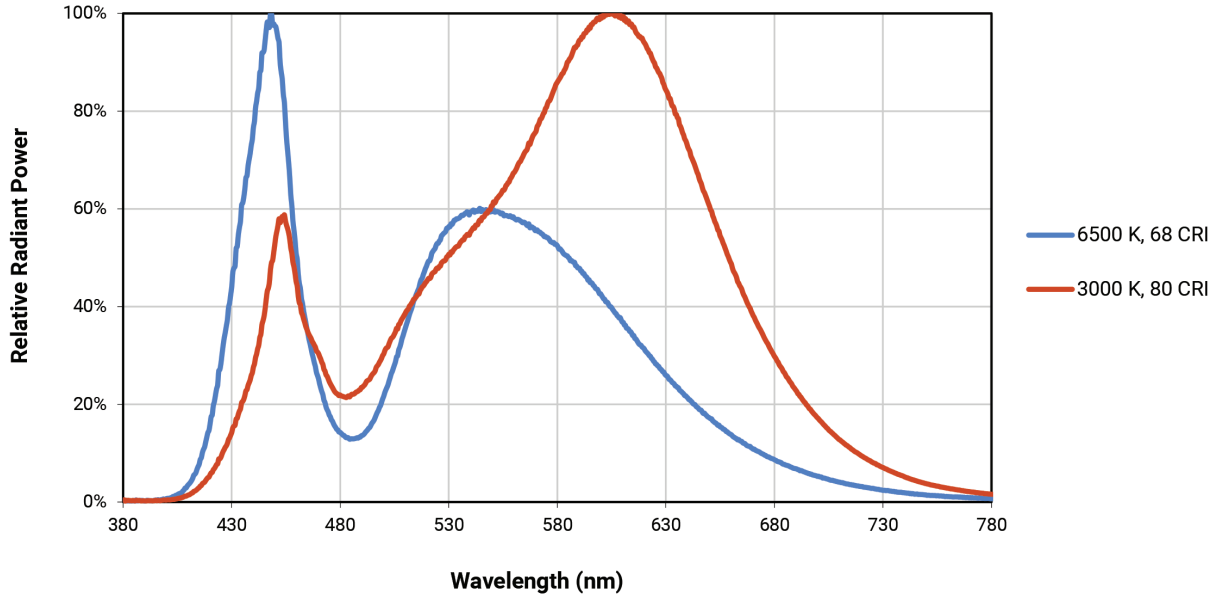

RELATIVE FLUX VS. JUNCTION TEMPERATURE

Reference condition: 3-V,  $I_F = 2800$  mA; 6 V,  $I_F = 1400$  mA; 12 V,  $I_F = 700$  mA

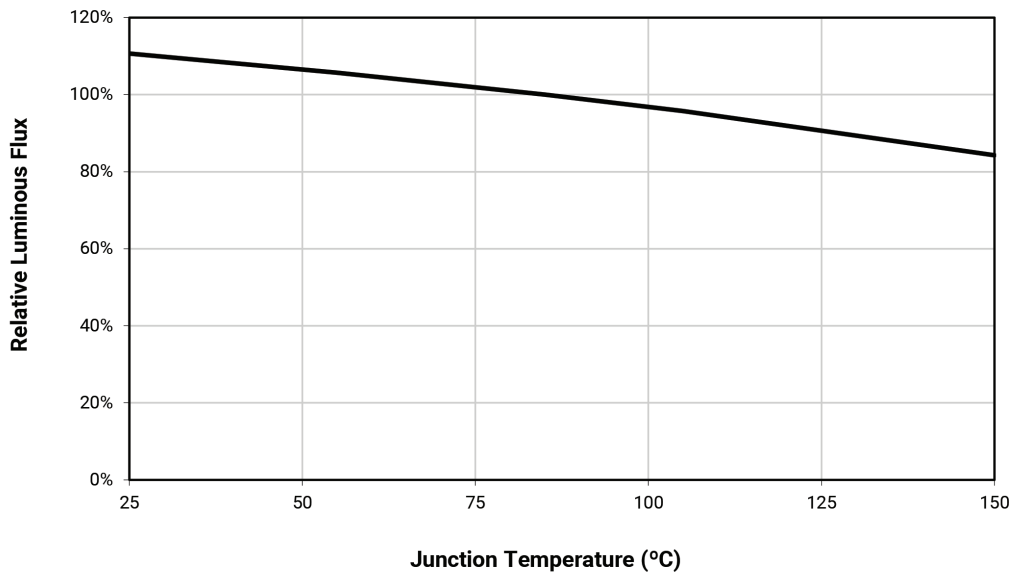

ELECTRICAL CHARACTERISTICS (T<sub>j</sub> = 85 °C)

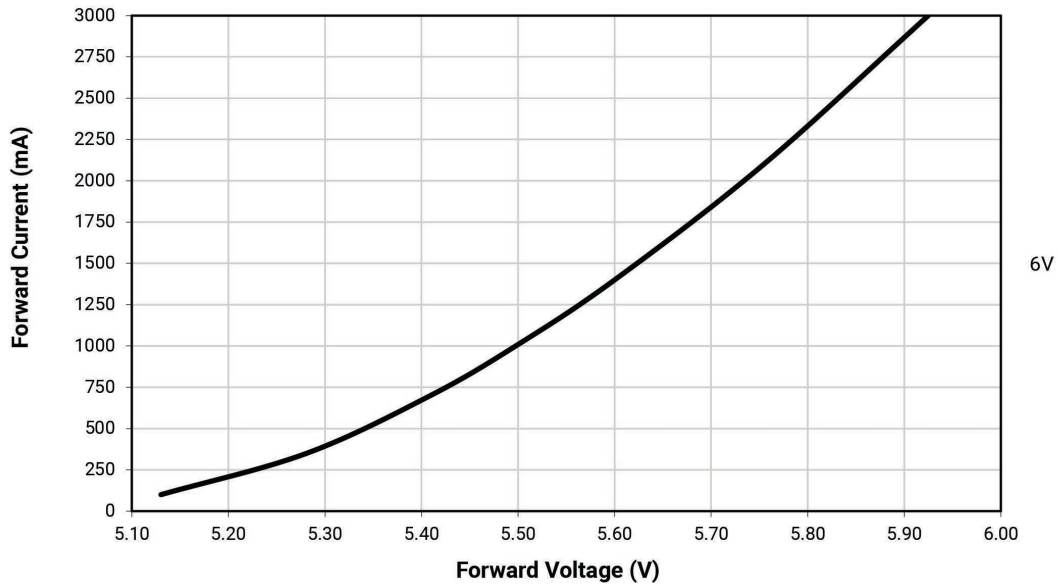
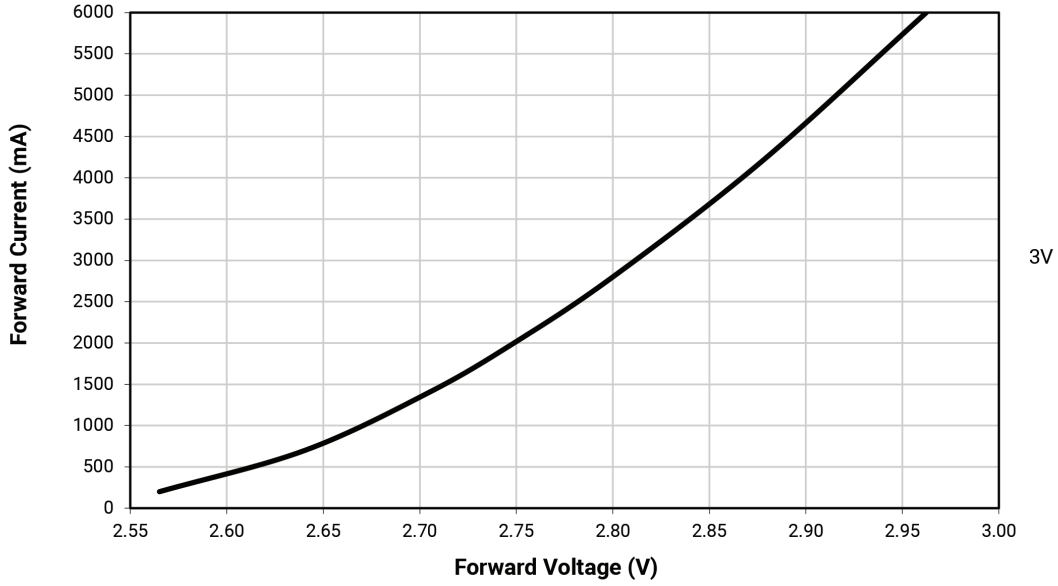



**ELECTRICAL CHARACTERISTICS ( $T_j = 85\text{ }^\circ\text{C}$ ) - CONTINUED**

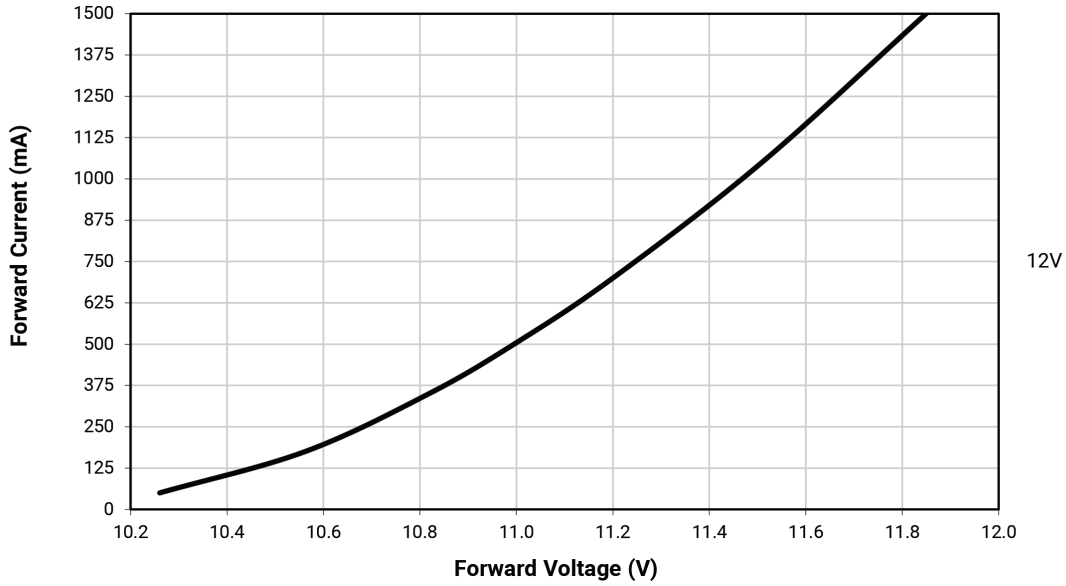

**RELATIVE FLUX VS. CURRENT ( $T_j = 85\text{ }^\circ\text{C}$ )**

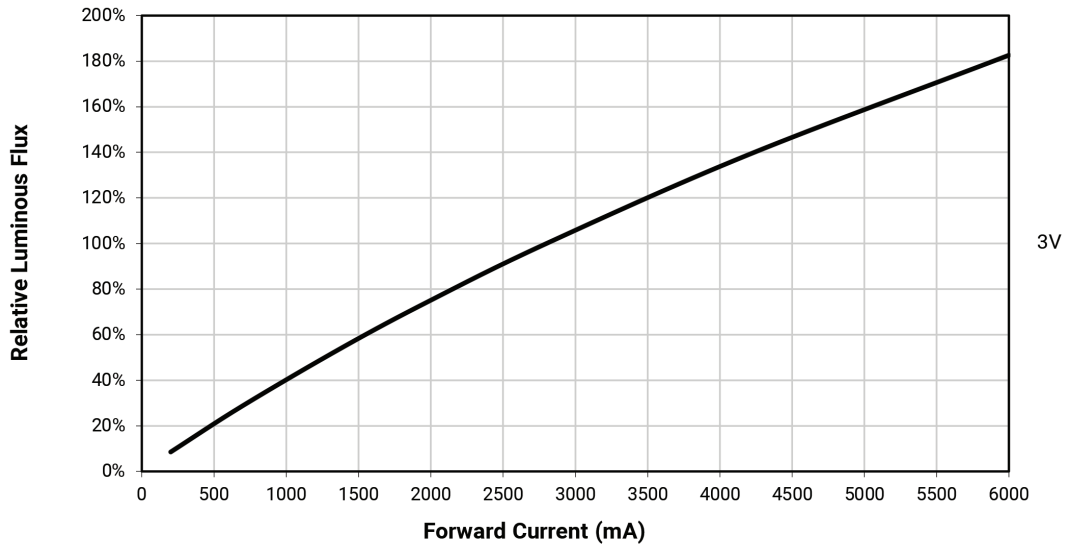

RELATIVE FLUX VS. CURRENT ( $T_j = 85\text{ }^\circ\text{C}$ ) - CONTINUED

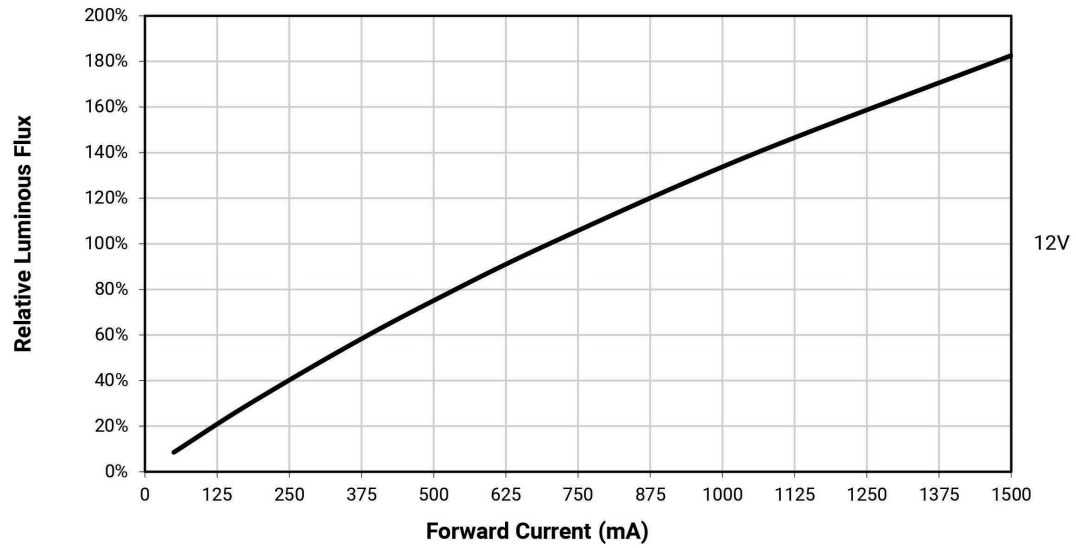
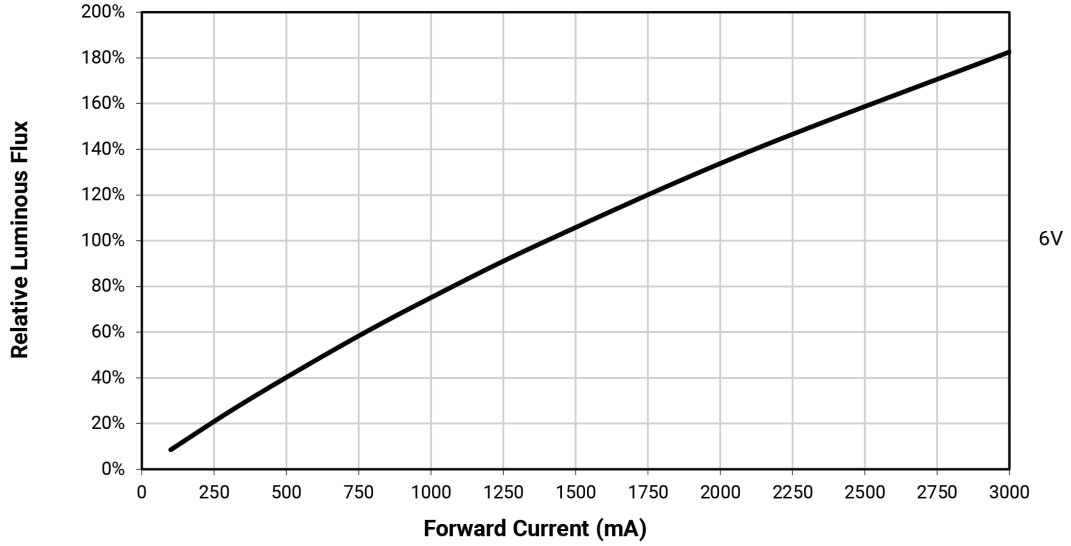

RELATIVE CHROMATICITY VS CURRENT (WARM WHITE)

XHP50.3 High Density

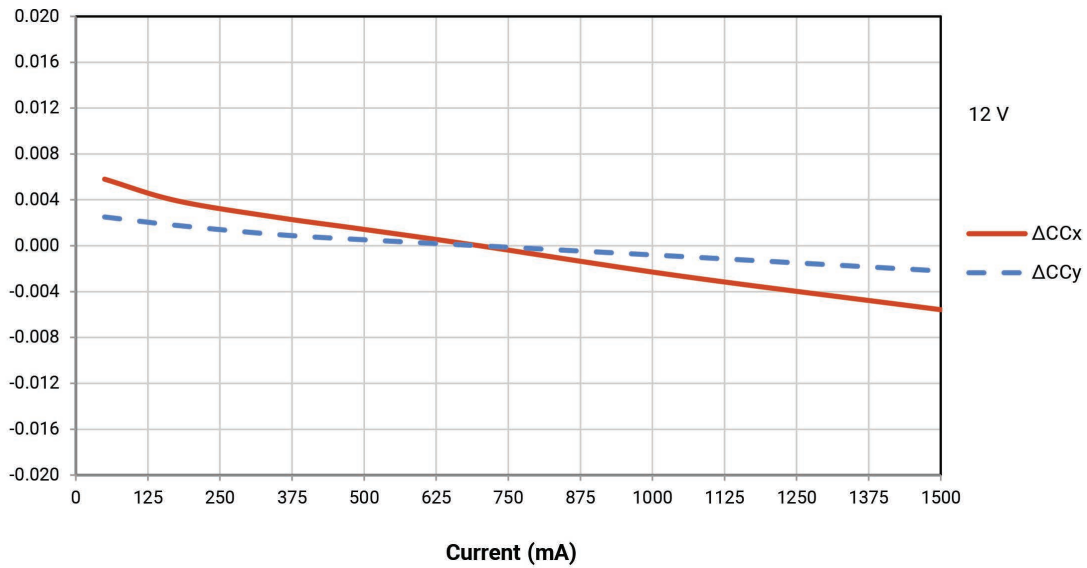
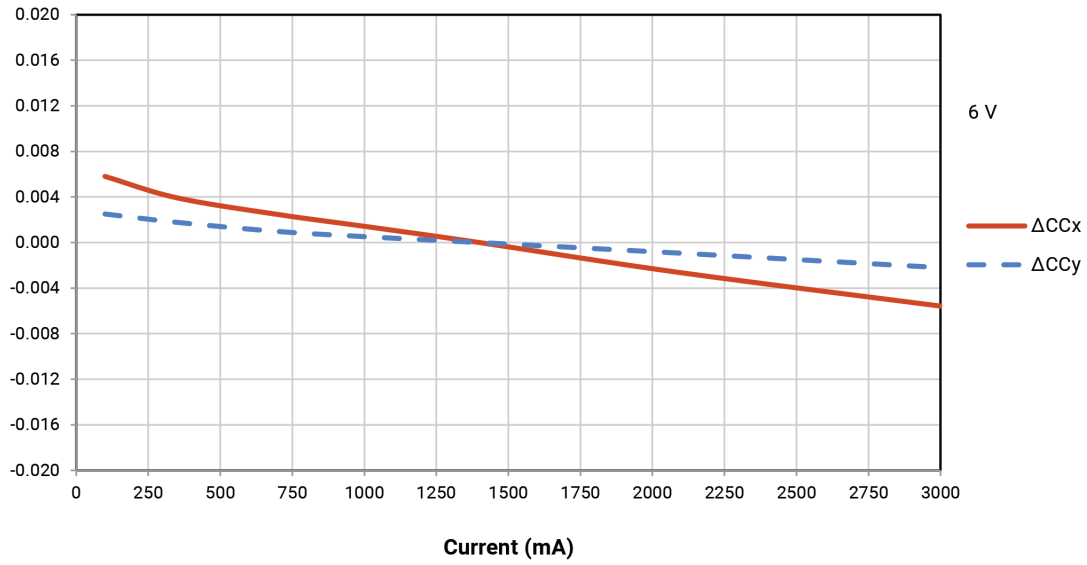

RELATIVE CHROMATICITY VS CURRENT (WARM WHITE) - CONTINUED

XHP50.3 High Intensity

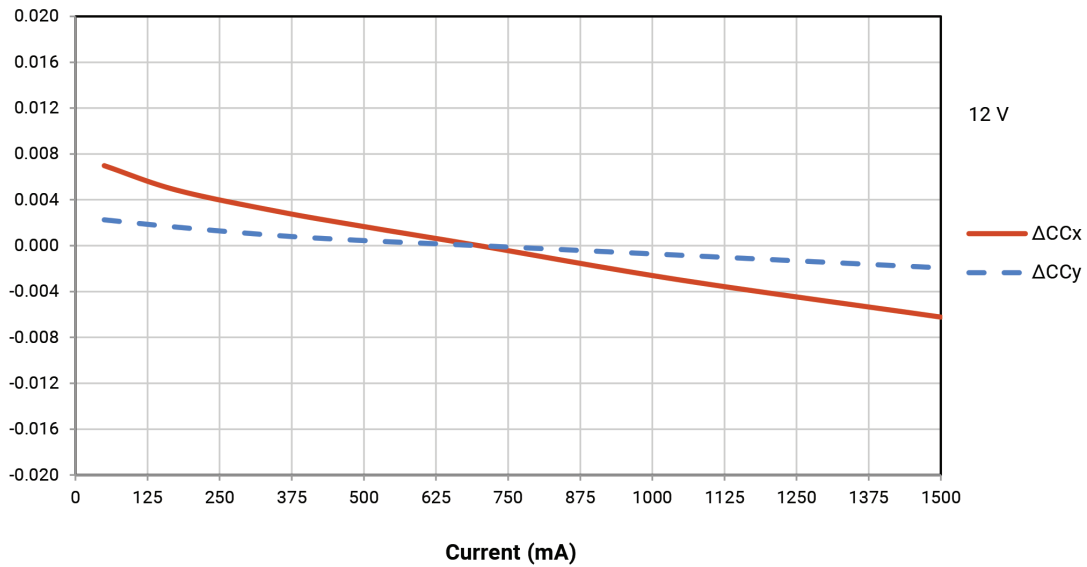
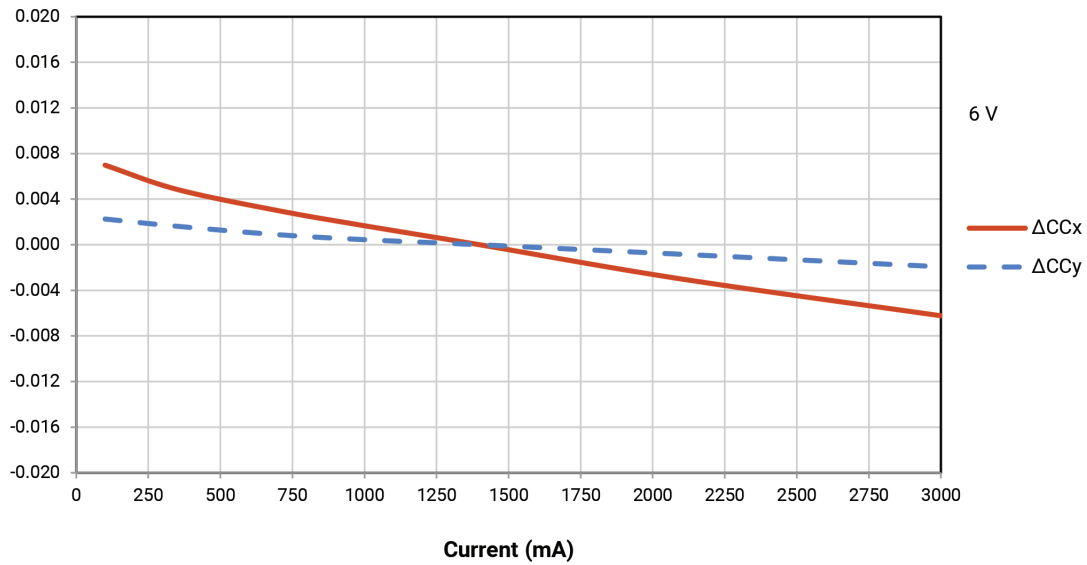

## RELATIVE CHROMATICITY VS TEMPERATURE (WARM WHITE)

Reference condition: 6 V,  $I_F = 1400$  mA; 12 V,  $I_F = 700$  mA

### XHP50.3 High Density

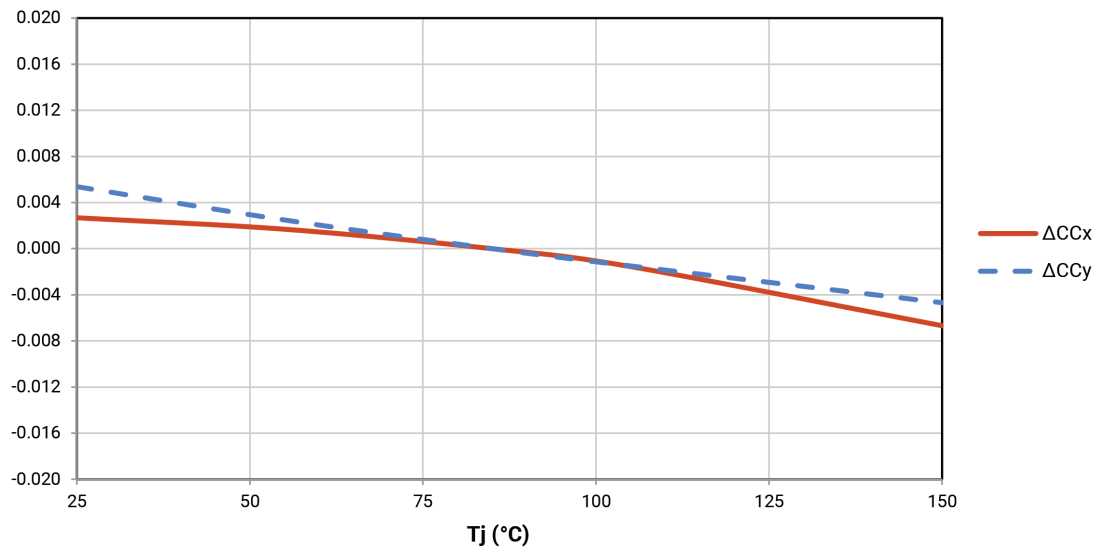

### XHP50.3 High Intensity

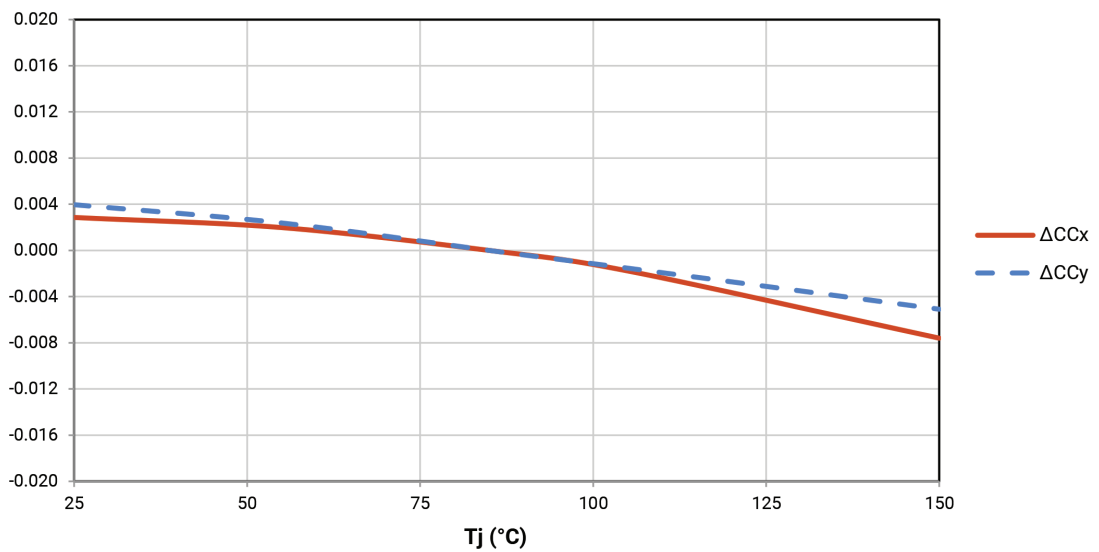

## TYPICAL SPATIAL DISTRIBUTION

Reference condition:  $T_j = 85\text{ °C}$ ; 3 V,  $I_f = 2800\text{ mA}$ ; 6 V,  $I_f = 1400\text{ mA}$ ; 12 V,  $I_f = 700\text{ mA}$

### XHP50.3 High Density

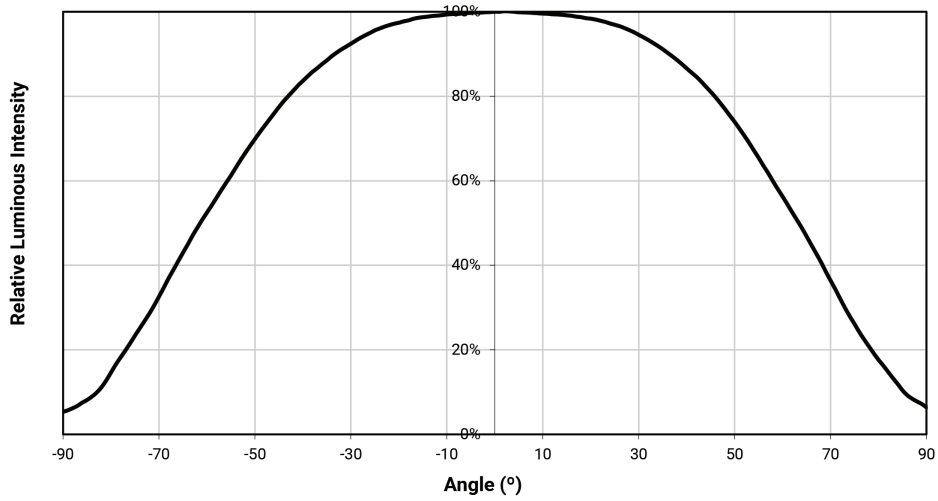

### XHP50.3 High Intensity

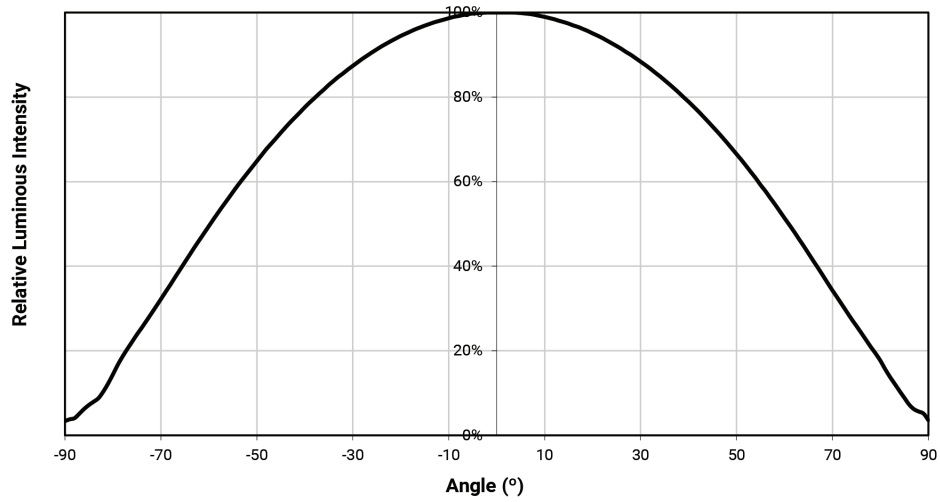

THERMAL DESIGN

The maximum forward current is determined by the thermal resistance between the LED junction and ambient. It is crucial for the end product to be designed in a manner that minimizes the thermal resistance from the solder point to ambient in order to optimize lamp life and optical characteristics.

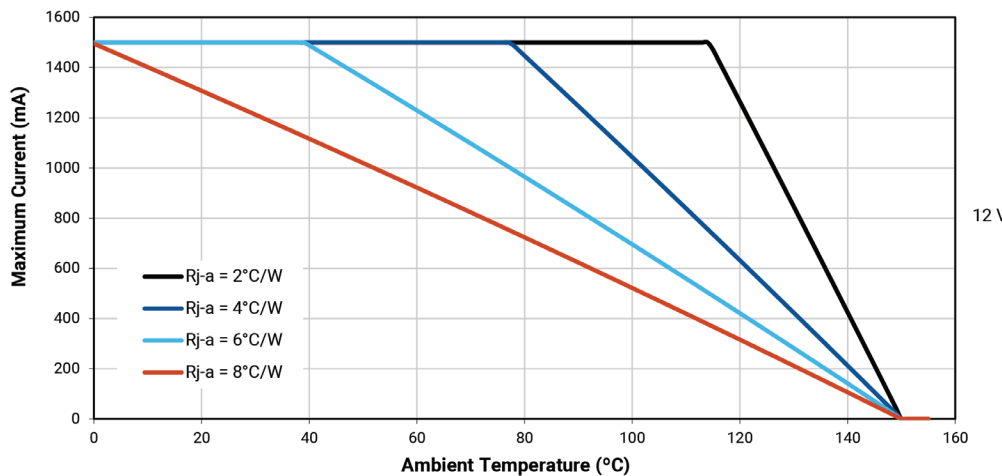
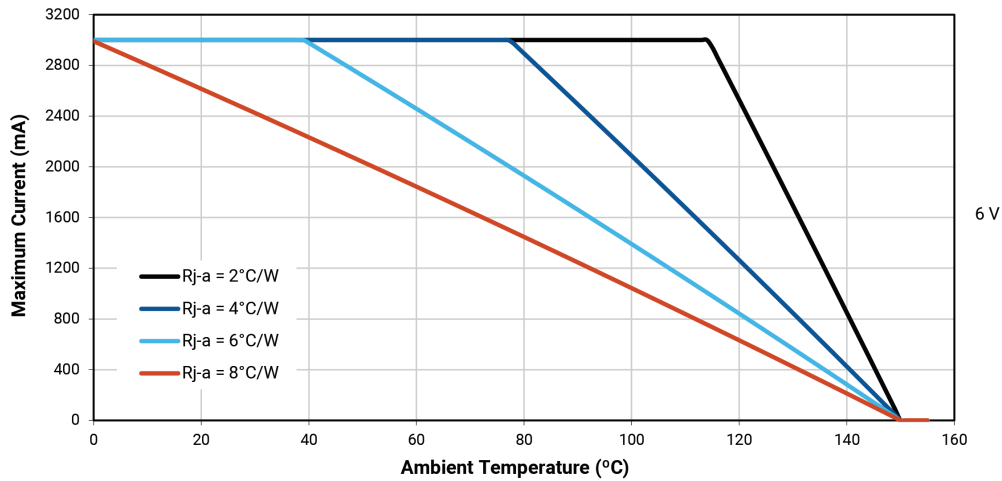
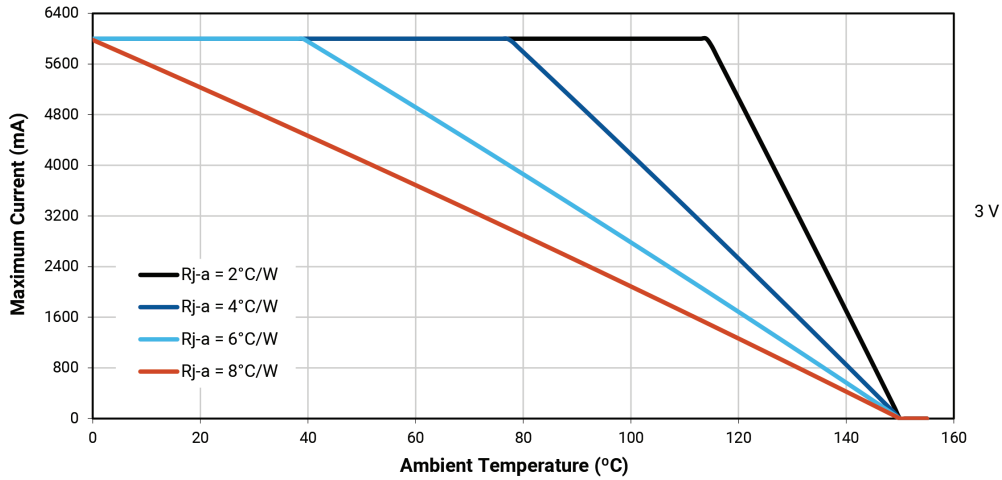

## PERFORMANCE GROUPS – LUMINOUS FLUX ( $T_j = 85\text{ }^\circ\text{C}$ )

XLamp XHP50.3 LEDs are tested for luminous flux and placed into one of the following luminous-flux groups.

| Group Code | Minimum Luminous Flux | Maximum Luminous Flux |
|------------|-----------------------|-----------------------|
| E4         | 635                   | 680                   |
| F2         | 680                   | 730                   |
| F4         | 730                   | 780                   |
| G2         | 780                   | 840                   |
| G4         | 840                   | 900                   |
| H2         | 900                   | 970                   |
| H4         | 970                   | 1040                  |
| J2         | 1040                  | 1120                  |
| J4         | 1120                  | 1200                  |
| K2         | 1200                  | 1290                  |
| K4         | 1290                  | 1380                  |

## PERFORMANCE GROUPS – CHROMATICITY

XLamp XHP50.3 LEDs are tested for chromaticity and placed into one of the regions defined by the following bounding coordinates.

| EasyWhite Color Temperatures – 2-Step |        |        |        |
|---------------------------------------|--------|--------|--------|
| Bin Code                              | CCT    | x      | y      |
| 40H                                   | 4000 K | 0.3777 | 0.3739 |
|                                       |        | 0.3797 | 0.3816 |
|                                       |        | 0.3861 | 0.3855 |
|                                       |        | 0.3838 | 0.3777 |
| 35H                                   | 3500 K | 0.4022 | 0.3858 |
|                                       |        | 0.4053 | 0.3942 |
|                                       |        | 0.4125 | 0.3977 |
|                                       |        | 0.4091 | 0.3891 |
| 30H                                   | 3000 K | 0.4287 | 0.3975 |
|                                       |        | 0.4328 | 0.4064 |
|                                       |        | 0.4390 | 0.4086 |
|                                       |        | 0.4347 | 0.3996 |
| 27H                                   | 2700 K | 0.4524 | 0.4048 |
|                                       |        | 0.4574 | 0.4140 |
|                                       |        | 0.4633 | 0.4154 |
|                                       |        | 0.4581 | 0.4062 |



PERFORMANCE GROUPS – CHROMATICITY (CONTINUED)

| EasyWhite Color Temperatures – 3-Step Ellipse |        |              |        |            |            |                    |
|---|--------|--------------|--------|------------|------------|--------------------|
| Bin Code                                      | CCT    | Center Point |        | Major Axis | Minor Axis | Rotation Angle (°) |
|   |        | x            | y      | a          | b          |                    |
| 50G   | 5000 K | 0.3447       | 0.3553 | 0.00840    | 0.00312    | 65.0               |
| 45G   | 4500 K | 0.3611       | 0.3658 | 0.00852    | 0.00330    | 61.5               |
| 40G   | 4000 K | 0.3818       | 0.3797 | 0.00939    | 0.00402    | 53.7               |
| 35G   | 3500 K | 0.4073       | 0.3917 | 0.00927    | 0.00414    | 54.0               |
| 30G   | 3000 K | 0.4338       | 0.4030 | 0.00834    | 0.00408    | 53.2               |
| 27G   | 2700 K | 0.4577       | 0.4099 | 0.00834    | 0.00420    | 48.5               |

| EasyWhite Color Temperatures – 5-Step Ellipse |        |              |        |            |            |                    |
|---|--------|--------------|--------|------------|------------|--------------------|
| Bin Code                                      | CCT    | Center Point |        | Major Axis | Minor Axis | Rotation Angle (°) |
|   |        | x            | y      | a          | b          |                    |
| 50E   | 5000 K | 0.3447       | 0.3553 | 0.01400    | 0.00520    | 65.0               |
| 45E   | 4500 K | 0.3611       | 0.3658 | 0.01420    | 0.00550    | 61.5               |
| 40E   | 4000 K | 0.3818       | 0.3797 | 0.01565    | 0.00670    | 53.7               |
| 35E   | 3500 K | 0.4073       | 0.3917 | 0.01545    | 0.00690    | 54.0               |
| 30E   | 3000 K | 0.4338       | 0.4030 | 0.01390    | 0.00680    | 53.2               |

| ANSI White Bins |          |        |        |
|-----------------|----------|--------|--------|
| CCT             | Bin Code | x      | y      |
| 7000 K          | 0A0      | 0.2950 | 0.2970 |
|                 |          | 0.2920 | 0.3060 |
|                 |          | 0.2984 | 0.3133 |
|                 |          | 0.3009 | 0.3042 |
|                 | 0B0      | 0.2920 | 0.3060 |
|                 |          | 0.2895 | 0.3135 |
|                 |          | 0.2962 | 0.3220 |
|                 |          | 0.2984 | 0.3133 |
|                 | 0C0      | 0.2984 | 0.3133 |
|                 |          | 0.2962 | 0.3220 |
|                 |          | 0.3028 | 0.3304 |
|                 |          | 0.3048 | 0.3207 |
|                 | 0D0      | 0.2984 | 0.3133 |
|                 |          | 0.3048 | 0.3207 |
|                 |          | 0.3068 | 0.3113 |
|                 |          | 0.3009 | 0.3042 |

| ANSI White Bins |          |        |        |
|-----------------|----------|--------|--------|
| CCT             | Bin Code | x      | y      |
| 7000 K          | 0R0      | 0.2980 | 0.2880 |
|                 |          | 0.2950 | 0.2970 |
|                 |          | 0.3009 | 0.3042 |
|                 |          | 0.3037 | 0.2937 |
|                 | 0S0      | 0.2895 | 0.3135 |
|                 |          | 0.2870 | 0.3210 |
|                 |          | 0.2937 | 0.3312 |
|                 |          | 0.2962 | 0.3220 |
|                 | 0T0      | 0.2962 | 0.3220 |
|                 |          | 0.2937 | 0.3312 |
|                 |          | 0.3005 | 0.3415 |
|                 |          | 0.3028 | 0.3304 |
|                 | 0U0      | 0.3037 | 0.2937 |
|                 |          | 0.3009 | 0.3042 |
|                 |          | 0.3068 | 0.3113 |
|                 |          | 0.3093 | 0.2993 |

| ANSI White Bins |          |        |        |
|-----------------|----------|--------|--------|
| CCT             | Bin Code | x      | y      |
| 7000 K          | 1A0      | 0.3048 | 0.3207 |
|                 |          | 0.3130 | 0.3290 |
|                 |          | 0.3144 | 0.3186 |
|                 |          | 0.3068 | 0.3113 |
|                 | 1B0      | 0.3028 | 0.3304 |
|                 |          | 0.3115 | 0.3391 |
|                 |          | 0.3130 | 0.3290 |
|                 |          | 0.3048 | 0.3207 |
|                 | 1C0      | 0.3115 | 0.3391 |
|                 |          | 0.3205 | 0.3481 |
|                 |          | 0.3213 | 0.3373 |
|                 |          | 0.3130 | 0.3290 |
|                 | 1D0      | 0.3130 | 0.3290 |
|                 |          | 0.3213 | 0.3373 |
|                 |          | 0.3221 | 0.3261 |
|                 |          | 0.3144 | 0.3186 |

PERFORMANCE GROUPS – CHROMATICITY (CONTINUED)

| ANSI White Bins |          |        |        |
|-----------------|----------|--------|--------|
| CCT             | Bin Code | x      | y      |
| 7000 K          | 1R0      | 0.3068 | 0.3113 |
|                 |          | 0.3144 | 0.3186 |
|                 |          | 0.3161 | 0.3059 |
|                 |          | 0.3093 | 0.2993 |
|                 | 1S0      | 0.3005 | 0.3415 |
|                 |          | 0.3099 | 0.3509 |
|                 |          | 0.3115 | 0.3391 |
|                 |          | 0.3028 | 0.3304 |
|                 | 1T0      | 0.3099 | 0.3509 |
|                 |          | 0.3196 | 0.3602 |
|                 |          | 0.3205 | 0.3481 |
|                 |          | 0.3115 | 0.3391 |
|                 | 1U0      | 0.3144 | 0.3186 |
|                 |          | 0.3221 | 0.3261 |
|                 |          | 0.3231 | 0.3120 |
|                 |          | 0.3161 | 0.3059 |

| ANSI White Bins |          |        |        |
|-----------------|----------|--------|--------|
| CCT             | Bin Code | x      | y      |
| 6000 K          | 2A0      | 0.3215 | 0.3350 |
|                 |          | 0.3290 | 0.3417 |
|                 |          | 0.3290 | 0.3300 |
|                 |          | 0.3222 | 0.3243 |
|                 | 2B0      | 0.3207 | 0.3462 |
|                 |          | 0.3290 | 0.3538 |
|                 |          | 0.3290 | 0.3417 |
|                 |          | 0.3215 | 0.3350 |
|                 | 2C0      | 0.3290 | 0.3538 |
|                 |          | 0.3376 | 0.3616 |
|                 |          | 0.3371 | 0.3490 |
|                 |          | 0.3290 | 0.3417 |
|                 | 2D0      | 0.3290 | 0.3417 |
|                 |          | 0.3371 | 0.3490 |
|                 |          | 0.3366 | 0.3369 |
|                 |          | 0.3290 | 0.3300 |

| ANSI White Bins |          |        |        |
|-----------------|----------|--------|--------|
| CCT             | Bin Code | x      | y      |
| 6000 K          | 2R0      | 0.3222 | 0.3243 |
|                 |          | 0.3290 | 0.3300 |
|                 |          | 0.3290 | 0.3180 |
|                 |          | 0.3231 | 0.3120 |
|                 | 2S0      | 0.3196 | 0.3602 |
|                 |          | 0.3290 | 0.3690 |
|                 |          | 0.3290 | 0.3538 |
|                 |          | 0.3207 | 0.3462 |
|                 | 2T0      | 0.3290 | 0.3690 |
|                 |          | 0.3381 | 0.3762 |
|                 |          | 0.3376 | 0.3616 |
|                 |          | 0.3290 | 0.3538 |
|                 | 2U0      | 0.3290 | 0.3300 |
|                 |          | 0.3366 | 0.3369 |
|                 |          | 0.3361 | 0.3245 |
|                 |          | 0.3290 | 0.3180 |

| ANSI White Bins |          |        |        |
|-----------------|----------|--------|--------|
| CCT             | Bin Code | x      | y      |
| 5000 K          | 3A0      | 0.3371 | 0.3490 |
|                 |          | 0.3451 | 0.3554 |
|                 |          | 0.3440 | 0.3427 |
|                 |          | 0.3366 | 0.3369 |
|                 | 3B0      | 0.3376 | 0.3616 |
|                 |          | 0.3463 | 0.3687 |
|                 |          | 0.3451 | 0.3554 |
|                 |          | 0.3371 | 0.3490 |
|                 | 3C0      | 0.3463 | 0.3687 |
|                 |          | 0.3551 | 0.3760 |
|                 |          | 0.3533 | 0.3620 |
|                 |          | 0.3451 | 0.3554 |
|                 | 3D0      | 0.3451 | 0.3554 |
|                 |          | 0.3533 | 0.3620 |
|                 |          | 0.3515 | 0.3487 |
|                 |          | 0.3440 | 0.3427 |

| ANSI White Bins |          |        |        |
|-----------------|----------|--------|--------|
| CCT             | Bin Code | x      | y      |
| 4500 K          | 4A0      | 0.3530 | 0.3597 |
|                 |          | 0.3615 | 0.3659 |
|                 |          | 0.3512 | 0.3465 |
|                 |          | 0.3515 | 0.3487 |
|                 | 4B0      | 0.3548 | 0.3736 |
|                 |          | 0.3641 | 0.3804 |
|                 |          | 0.3530 | 0.3597 |
|                 |          | 0.3533 | 0.362  |
|                 | 4C0      | 0.3641 | 0.3804 |
|                 |          | 0.3736 | 0.3874 |
|                 |          | 0.3702 | 0.3722 |
|                 |          | 0.3615 | 0.3659 |
|                 | 4D0      | 0.3615 | 0.3659 |
|                 |          | 0.3702 | 0.3722 |
|                 |          | 0.3670 | 0.3578 |
|                 |          | 0.3590 | 0.3521 |

PERFORMANCE GROUPS – CHROMATICITY (CONTINUED)

| ANSI White Bins |          |        |        | ANSI White Bins |          |        |        | ANSI White Bins |          |        |        |
|-----------------|----------|--------|--------|-----------------|----------|--------|--------|-----------------|----------|--------|--------|
| CCT             | Bin Code | x      | y      | CCT             | Bin Code | x      | y      | CCT             | Bin Code | x      | y      |
| 4000 K          | 5A0      | 0.3670 | 0.3578 | 3500 K          | 6A0      | 0.3889 | 0.3690 | 3000 K          | 7A0      | 0.4147 | 0.3814 |
|                 |          | 0.3702 | 0.3722 |                 |          | 0.3941 | 0.3848 |                 |          | 0.4221 | 0.3984 |
|                 |          | 0.3825 | 0.3798 |                 |          | 0.4080 | 0.3916 |                 |          | 0.4342 | 0.4028 |
|                 |          | 0.3783 | 0.3646 |                 |          | 0.4017 | 0.3751 |                 |          | 0.4259 | 0.3853 |
|                 | 5B0      | 0.3702 | 0.3722 |                 | 6B0      | 0.3941 | 0.3848 |                 | 7B0      | 0.4221 | 0.3984 |
|                 |          | 0.3736 | 0.3874 |                 |          | 0.3996 | 0.4015 |                 |          | 0.4299 | 0.4165 |
|                 |          | 0.3869 | 0.3958 |                 |          | 0.4146 | 0.4089 |                 |          | 0.4430 | 0.4212 |
|                 |          | 0.3825 | 0.3798 |                 |          | 0.4080 | 0.3916 |                 |          | 0.4342 | 0.4028 |
|                 | 5C0      | 0.3825 | 0.3798 |                 | 6C0      | 0.4080 | 0.3916 |                 | 7C0      | 0.4342 | 0.4028 |
|                 |          | 0.3869 | 0.3958 |                 |          | 0.4146 | 0.4089 |                 |          | 0.4430 | 0.4212 |
|                 |          | 0.4006 | 0.4044 |                 |          | 0.4299 | 0.4165 |                 |          | 0.4562 | 0.4260 |
|                 |          | 0.3950 | 0.3875 |                 |          | 0.4221 | 0.3984 |                 |          | 0.4465 | 0.4071 |
|                 | 5D0      | 0.3783 | 0.3646 | 6D0             | 0.4017   | 0.3751 | 7D0    | 0.4259          | 0.3853   |        |        |
|                 |          | 0.3825 | 0.3798 |                 | 0.4080   | 0.3916 |        | 0.4342          | 0.4028   |        |        |
|                 |          | 0.3950 | 0.3875 |                 | 0.4221   | 0.3984 |        | 0.4465          | 0.4071   |        |        |
|                 |          | 0.3898 | 0.3716 |                 | 0.4147   | 0.3814 |        | 0.4373          | 0.3893   |        |        |

EASYWHITE® CHROMATICITY REGIONS PLOTTED ON THE 1931 CIE CURVE

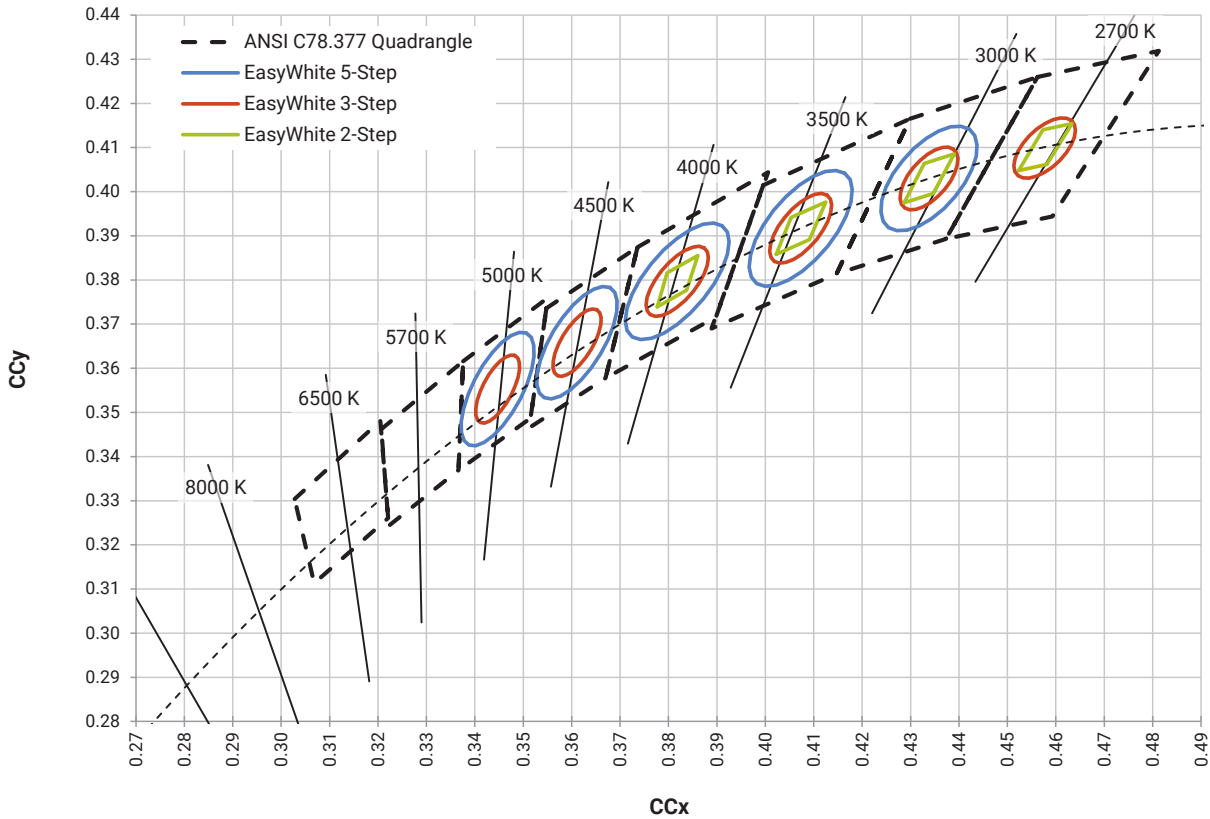

ANSI COOL WHITE KITS PLOTTED ON ANSI STANDARD CHROMATICITY REGIONS

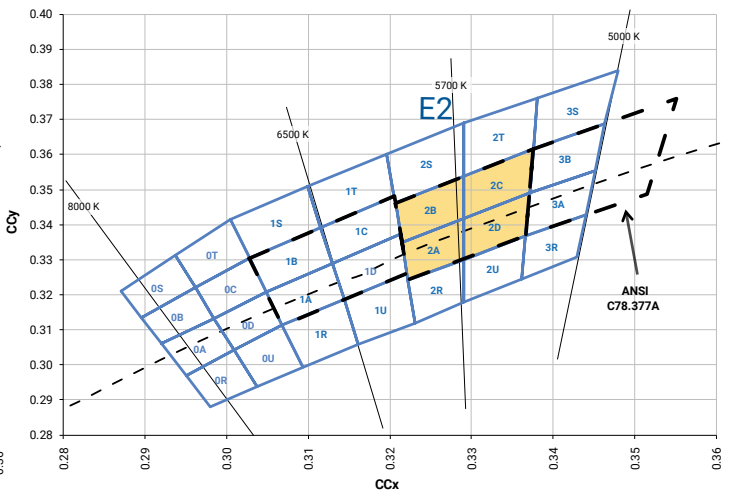
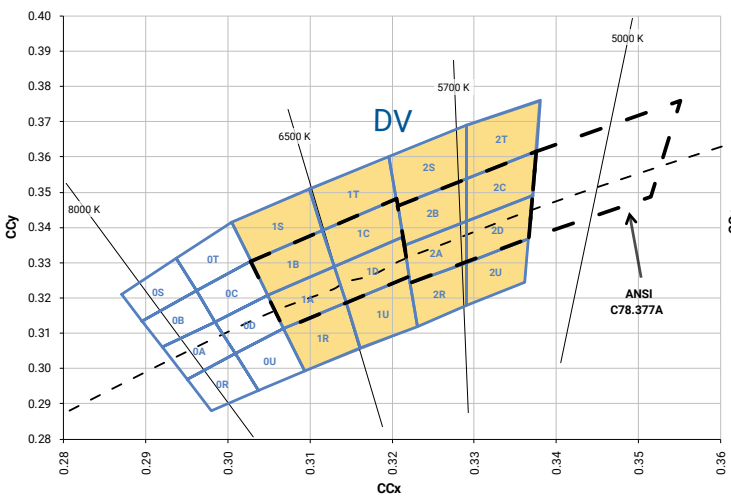
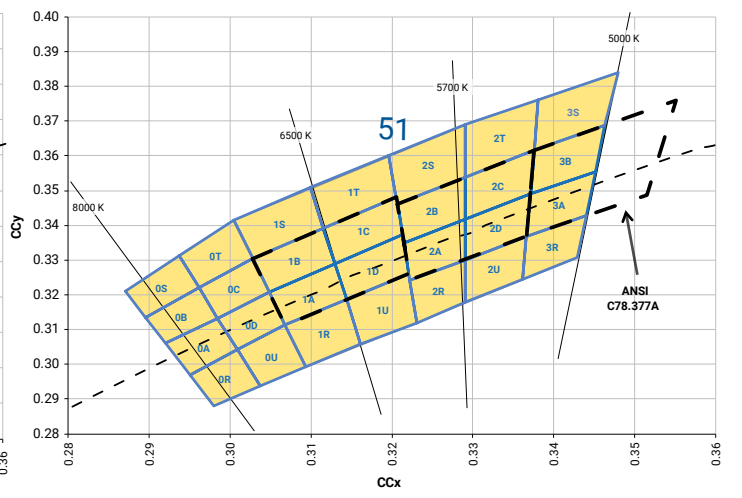
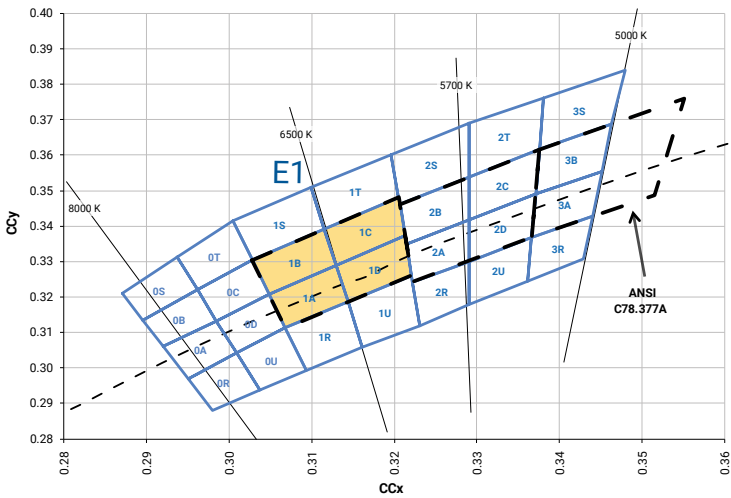
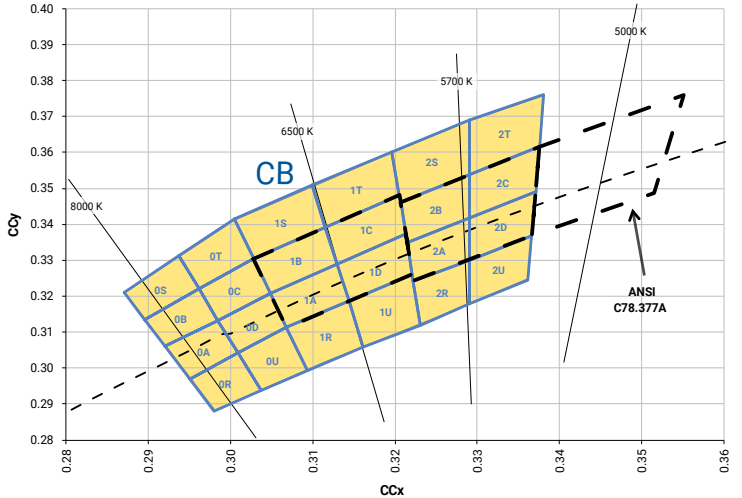
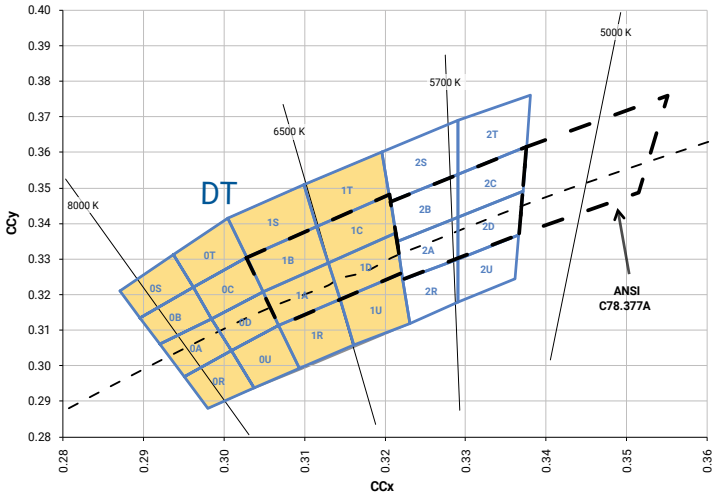

ANSI WARM AND NEUTRAL WHITE KITS PLOTTED ON ANSI STANDARD CHROMATICITY REGIONS

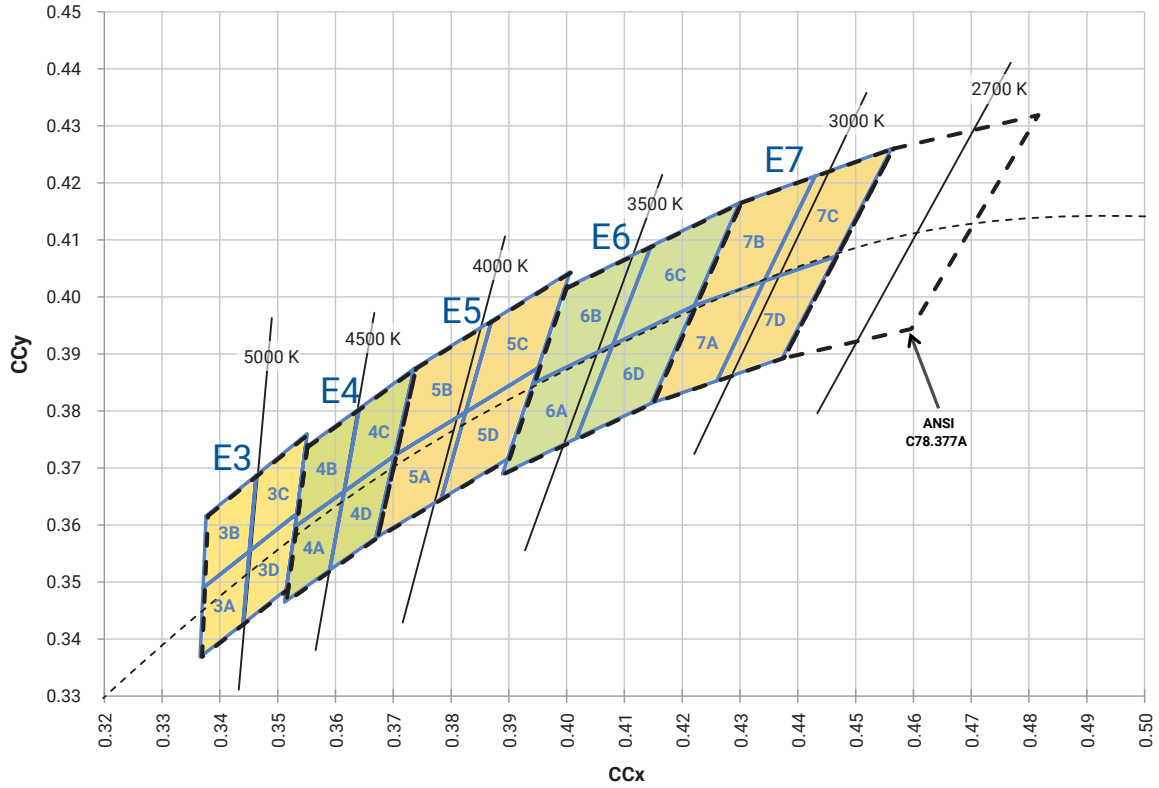

## BIN AND ORDER CODE FORMATS

Bin codes and order codes for XHP50.3 LEDs are configured in the following manner:

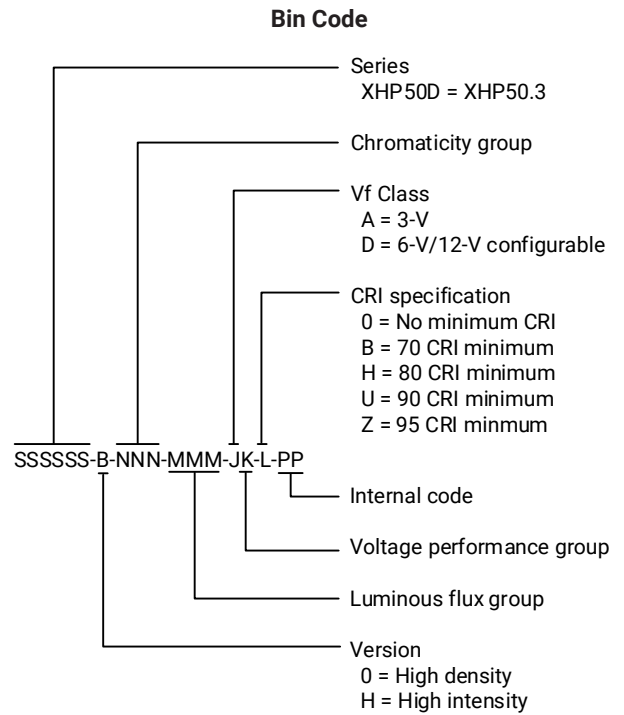
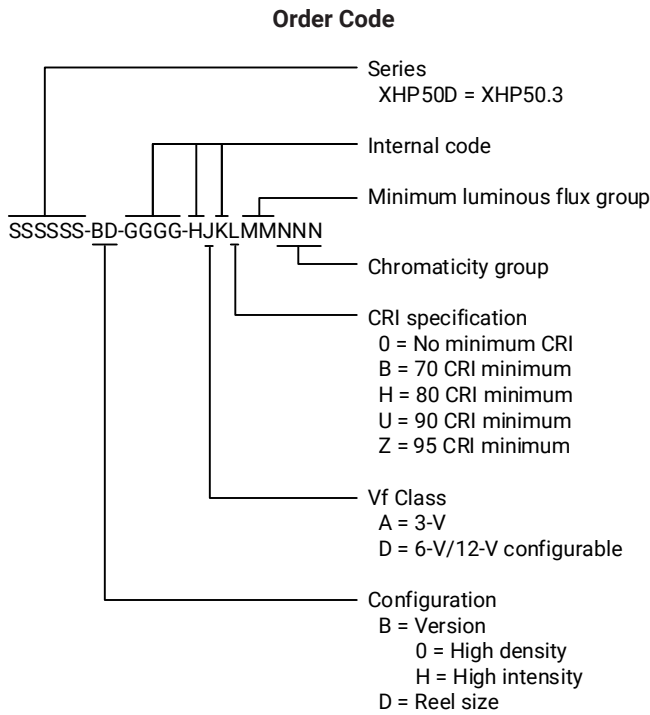

## REFLOW SOLDERING CHARACTERISTICS

In testing, Cree LED has found XLamp XHP50.3 LEDs to be compatible with JEDEC J-STD-020C, using the parameters listed below. As a general guideline, Cree LED recommends that users follow the recommended soldering profile provided by the manufacturer of the solder paste used, and therefore it is the lamp or luminaire manufacturer’s responsibility to determine applicable soldering requirements.

Note that this general guideline may not apply to all PCB designs and configurations of reflow soldering equipment.

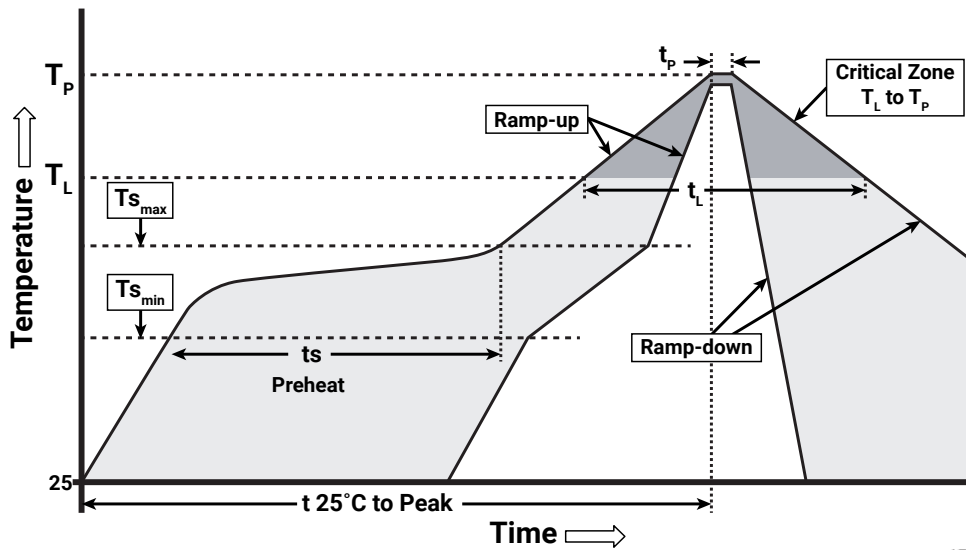

IPC/JEDEC J-STD-020C

| Profile Feature                                       | Lead-Free Solder |
|---|------------------|
| Average Ramp-Up Rate ( $T_{s_{max}}$ to $T_p$ )       | 1.2 °C/second    |
| Preheat: Temperature Min ( $T_{s_{min}}$ )            | 120 °C           |
| Preheat: Temperature Max ( $T_{s_{max}}$ )            | 170 °C           |
| Preheat: Time ( $t_{s_{min}}$ to $t_{s_{max}}$ )      | 65-150 seconds   |
| Time Maintained Above: Temperature ( $T_L$ )          | 217 °C           |
| Time Maintained Above: Time ( $t_L$ )                 | 45-90 seconds    |
| Peak/Classification Temperature ( $T_p$ )             | 235 - 245 °C     |
| Time Within 5 °C of Actual Peak Temperature ( $t_p$ ) | 20-40 seconds    |
| Ramp-Down Rate  | 1 - 6 °C/second  |
| Time 25 °C to Peak Temperature                        | 4 minutes max.   |

Note: All temperatures refer to the topside of the package, measured on the package body surface.

## NOTES

---

### Measurements

The luminous flux, radiant power, chromaticity, forward voltage and CRI measurements in this document are binning specifications only and solely represent product measurements as of the date of shipment. These measurements will change over time based on a number of factors that are not within Cree LED's control and are not intended or provided as operational specifications for the products. Calculated values are provided for informational purposes only and are not intended or provided as specifications.

### Pre-Release Qualification Testing

Please read the [LED Reliability Overview](#) for details of the qualification process Cree LED applies to ensure long-term reliability for XLamp LEDs and details of Cree LED's pre-release qualification testing for XLamp LEDs. Cree LED did not perform Room Temperature Operating Life (RTOL) testing on the XHP50.3 LED.

### Lumen Maintenance

Cree LED now uses standardized IES LM-80-08 and TM-21-11 methods for collecting long-term data and extrapolating LED lumen maintenance. For information on the specific LM-80 data sets available for this LED, refer to the public [LM-80 results document](#).

Please read the [Long-Term Lumen Maintenance application note](#) for more details on Cree LED's lumen maintenance testing and forecasting. Please read the [Thermal Management application note](#) for details on how thermal design, ambient temperature, and drive current affect the LED junction temperature.

### Moisture Sensitivity

Cree LED recommends keeping XLamp LEDs in the provided, resealable moisture-barrier packaging (MBP) until immediately prior to soldering. Unopened MBPs that contain XLamp LEDs do not need special storage for moisture sensitivity.

Once the MBP is opened, XLamp XHP50.3 LEDs may be stored as MSL 1 per JEDEC J-STD-033, meaning they have unlimited floor life in conditions of  $\leq 30$  °C/85% relative humidity (RH). Regardless of the storage condition, Cree LED recommends sealing any unsoldered LEDs in the original MBP.

### RoHS Compliance

The levels of RoHS restricted materials in this product are below the maximum concentration values (also referred to as the threshold limits) permitted for such substances, or are used in an exempted application, in accordance with EU Directive 2011/65/EC (RoHS2), as implemented January 2, 2013. RoHS Declarations for this product can be obtained from your Cree LED representative or from the [Product Ecology](#) section of the Cree LED website.

### REACH Compliance

REACH substances of very high concern (SVHCs) information is available for this product. Since the European Chemical Agency (ECHA) has published notice of their intent to frequently revise the SVHC listing for the foreseeable future, please contact a Cree LED representative to insure you get the most up-to-date REACH SVHC Declaration. REACH banned substance information (REACH Article 67) is also available upon request.



## NOTES - CONTINUED

---

### **UL® Recognized Component**

This product meets the requirements to be considered a UL Recognized Component with Level 4 enclosure consideration. The LED package or a portion thereof has been investigated as a fire and electrical enclosure per ANSI/UL 8750.

### **Vision Advisory**

WARNING: Do not look at an exposed lamp in operation. Eye injury can result. For more information about LEDs and eye safety, please refer to the [LED Eye Safety application note](#).

## MECHANICAL DIMENSIONS

Thermal vias, if present, are not shown on these drawings.

All dimensions are  $\pm 0.13$  mm unless otherwise indicated.

### XHP50.3 High Density

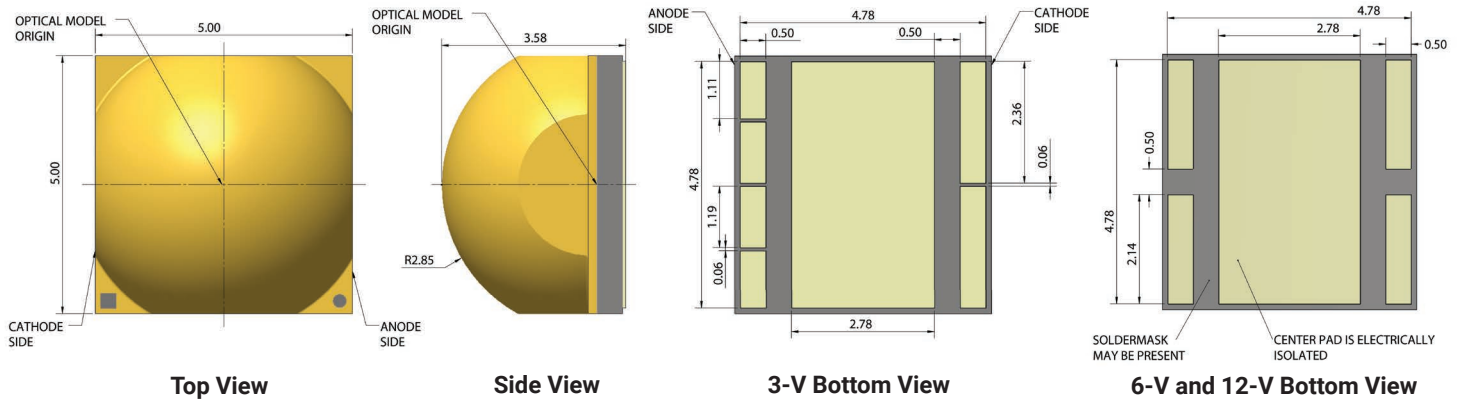

### XHP50.3 High Intensity

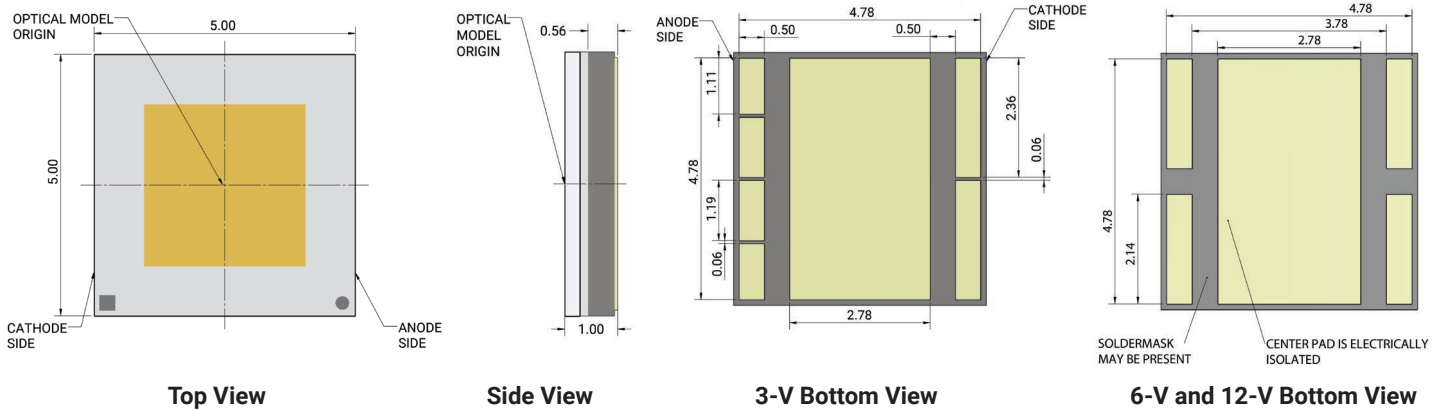

**MECHANICAL DIMENSIONS - CONTINUED**

**XHP50.3 High Density & High Intensity**

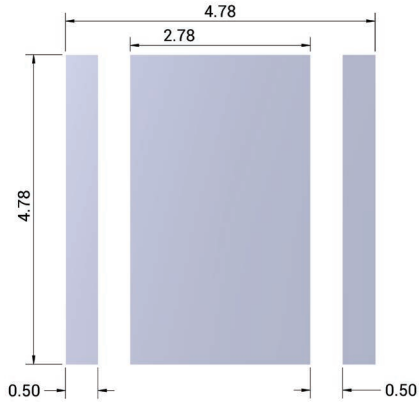

**3 V and 6 V PCB Footprint**  
(Thermal pad is electrically isolated)

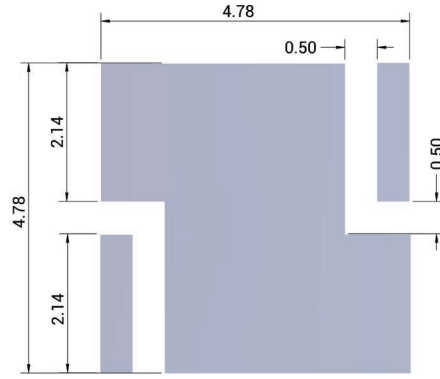

**12 V PCB Footprint**  
(Thermal pad is connected to anode and cathode and is not electrically isolated)

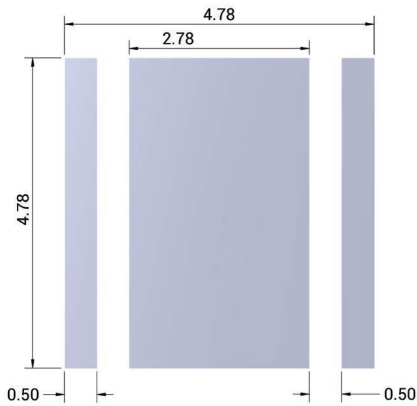

**3 V PCB Solder Mask Opening**

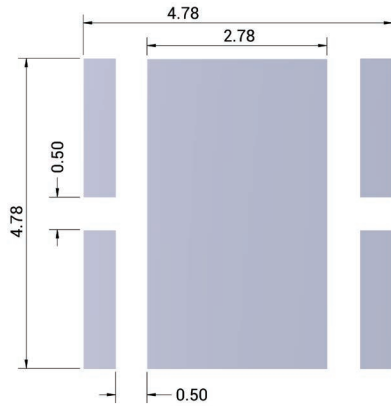

**6 V and 12 V PCB Solder Mask Opening**

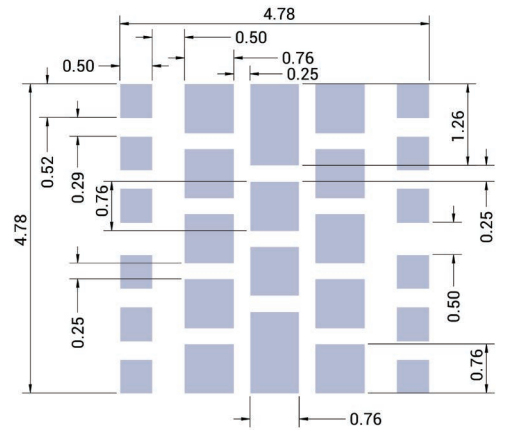

**3 V, 6 V and 12 V Stencil Opening**

ELECTRICAL CONFIGURATION

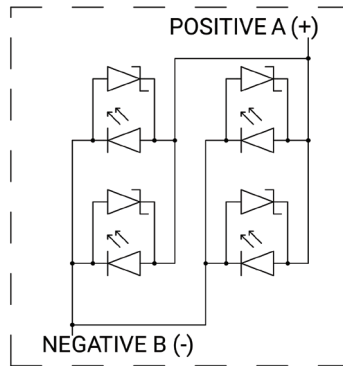

3-V Configuration

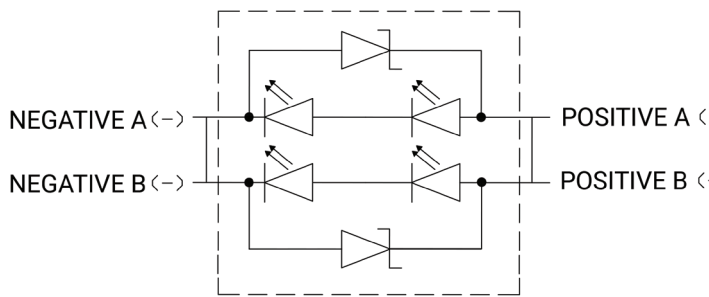

6-V Configuration

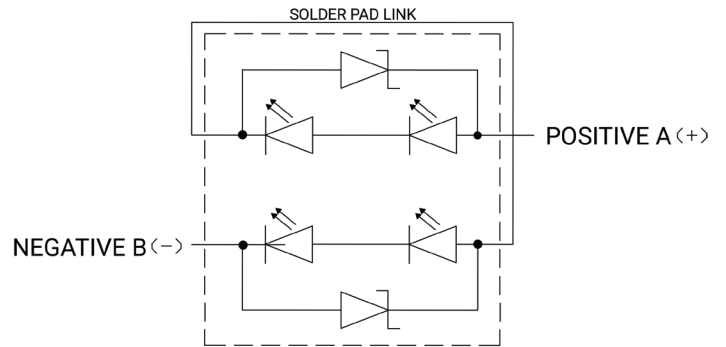

12-V Configuration

**TAPE AND REEL**

All Cree LED carrier tapes conform to EIA-481D, Automated Component Handling Systems Standard.

All dimensions in mm.

All dimensions are ±.13 mm unless otherwise indicated.

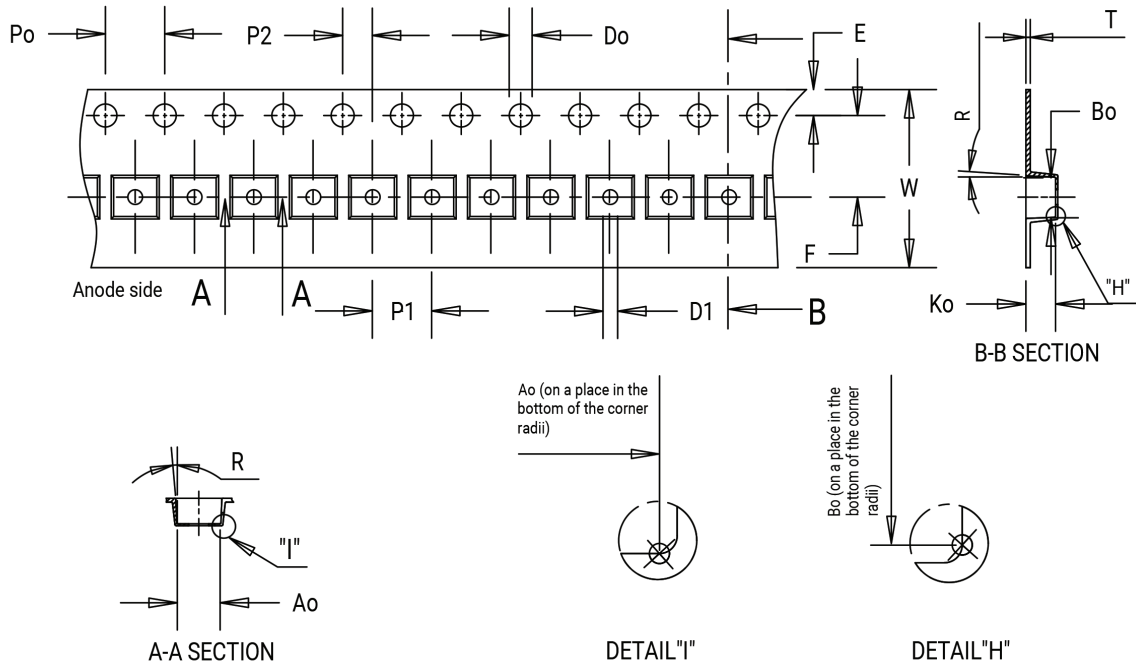

**XHP50.3 High Density**

| Item | Ao   | Bo   | Ko   | Po   | P1   | P2   | T    | E    | F    | Do   | D1   | W     | R  |
|------|------|------|------|------|------|------|------|------|------|------|------|-------|----|
| Dim. | 5.30 | 5.30 | 3.70 | 4.00 | 8.00 | 2.00 | 0.36 | 1.75 | 5.50 | 1.50 | 1.50 | 12.00 | 5° |

**XHP50.3 High Intensity**

| Item | Ao   | Bo   | Ko  | Po   | P1   | P2   | T    | E    | F    | Do   | D1   | W     | R  |
|------|------|------|-----|------|------|------|------|------|------|------|------|-------|----|
| Dim. | 5.40 | 5.40 | 1.5 | 4.00 | 8.00 | 2.00 | 0.30 | 1.75 | 5.50 | 1.50 | 1.50 | 12.00 | 7° |

**TAPE AND REEL - CONTINUED**

**XHP50.3 High Density**

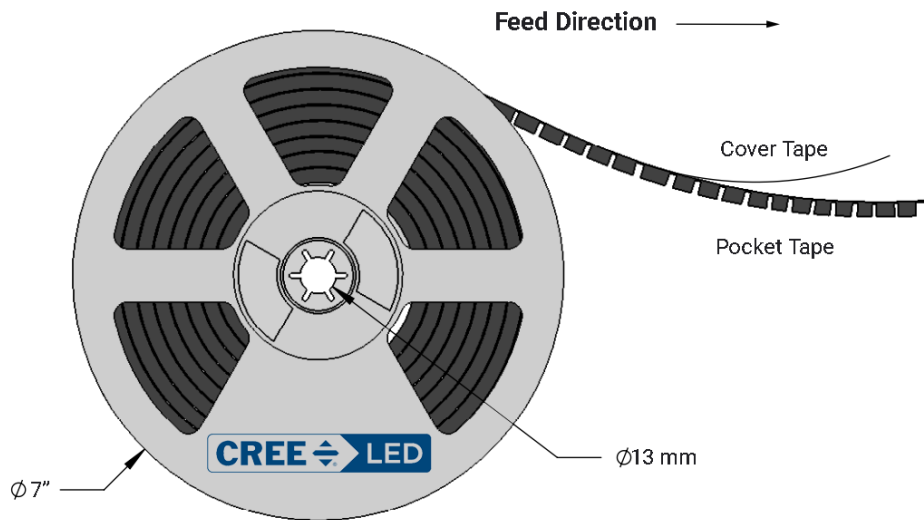
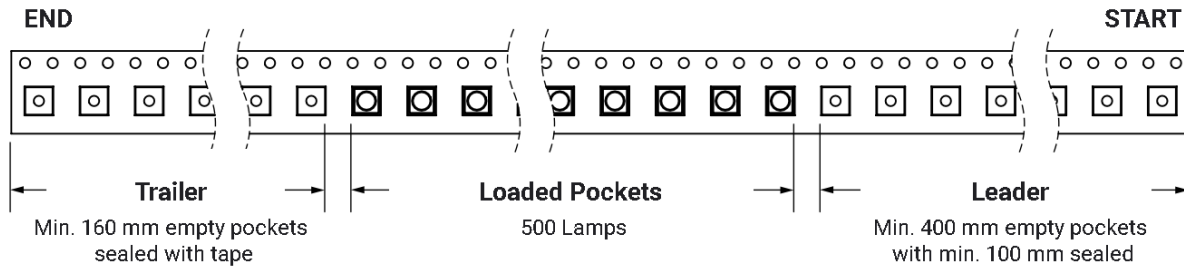

**TAPE AND REEL - CONTINUED**

**XHP50.3 High Intensity**

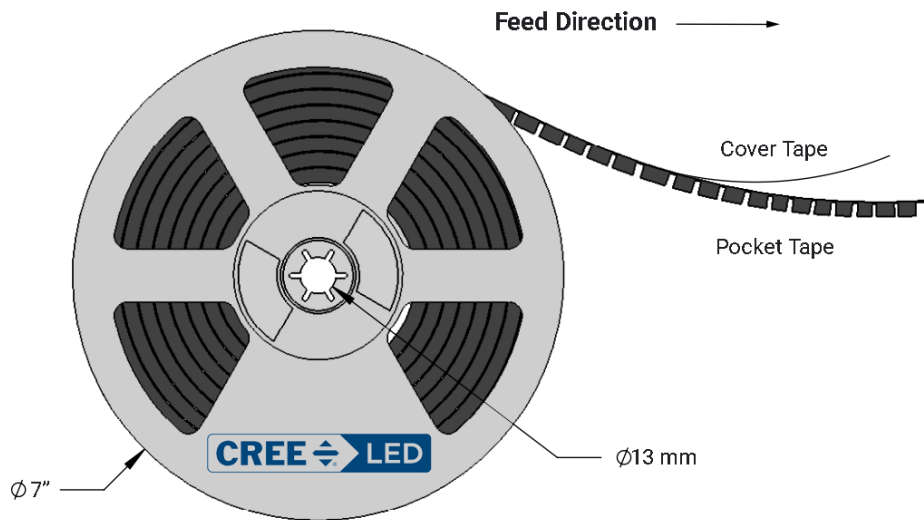
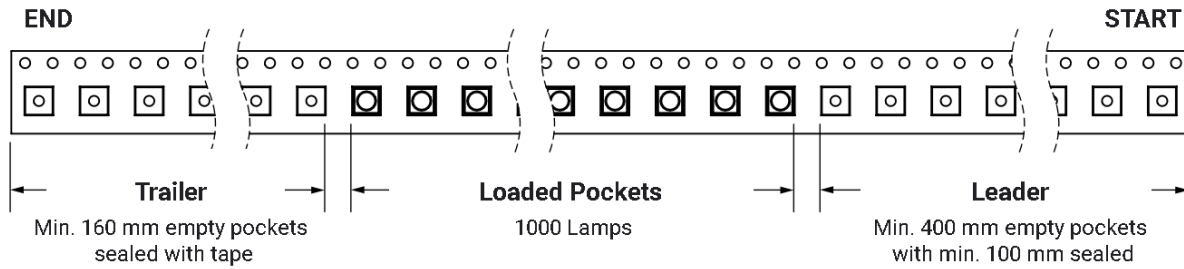

## PACKAGING

### Unpackaged Reel

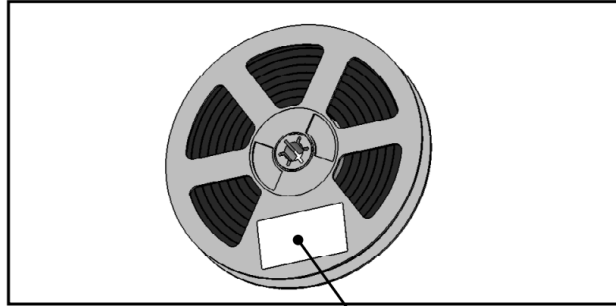

Label with Cree LED Bin Code, Quantity, Reel ID

### Packaged Reel

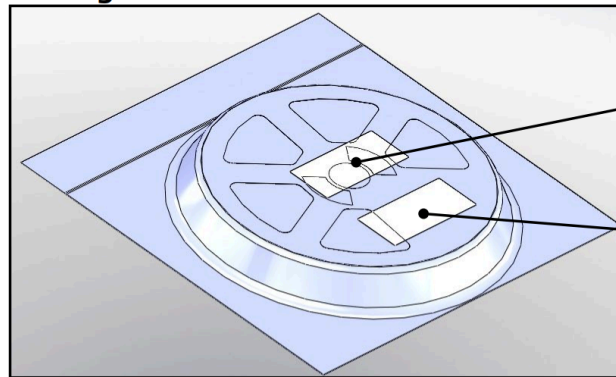

Label with Cree LED Order Code, Quantity, Reel ID, PO#

Label with Cree LED Bin Code, Quantity, Reel ID

### Boxed Reel

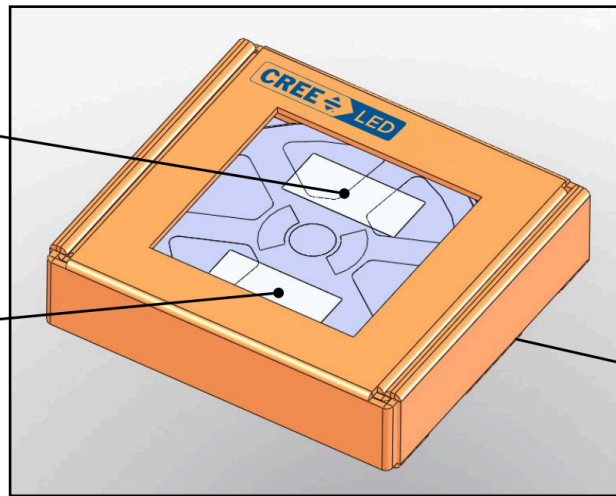

Label with Cree LED Order Code, Quantity, Reel ID, PO#

Label with Cree LED Bin Code, Quantity, Reel ID

Patent Label (on bottom of box)



**APPENDIX - ORDER CODES NOT FOR NEW DESIGNS**

The following order codes are active and valid order codes, but higher performance options are also available. Please see page 4 - page 7 for order codes of XLamp XHP50.3 EasyWhite LEDs that could serve as alternatives for the order codes set forth below.

**XHP50.3 6-V & 12-V EasyWhite, T<sub>j</sub> = 85 °C**

| Nominal CCT | Min CRI | Minimum Luminous Flux (lm) |           | 2-Step |                          | Group | Order Code               | Group | Order Code               |
|-------------|---------|----------------------------|-----------|--------|--------------------------|-------|--------------------------|-------|--------------------------|
|             |         | Code                       | Flux (lm) | Group  | Order Code               |       |                          |       |                          |
| 5000 K      | 70      | J2                         | 1040      |        |                          |       |                          | 50E   | XHP50B-00-0000-0D0BJ250E |
|             | 80      | H4                         | 970       |        |                          | 50G   | XHP50B-00-0000-0D0HH450G |       |                          |
| 4500 K      | 70      | J2                         | 1040      |        |                          |       |                          | 45E   | XHP50B-00-0000-0D0BJ245E |
|             | 80      | H4                         | 970       |        |                          | 50G   | XHP50B-00-0000-0D0HH445G |       |                          |
| 4000 K      | 70      | J2                         | 1040      |        |                          |       |                          | 40E   | XHP50B-00-0000-0D0BJ240E |
|             | 80      | H4                         | 970       | 40H    | XHP50B-00-0000-0D0HH440H | 40G   | XHP50B-00-0000-0D0HH440G |       |                          |
| 3500 K      | 80      | H4                         | 970       | 35H    | XHP50B-00-0000-0D0HH435H | 35G   | XHP50B-00-0000-0D0HH435G | 35E   | XHP50B-00-0000-0D0BJ235E |
|             |         | H2                         | 900       | 35H    | XHP50B-00-0000-0D0HH235H | 35G   | XHP50B-00-0000-0D0HH235G |       |                          |
| 3000 K      | 70      | H4                         | 970       |        |                          |       |                          | 30E   | XHP50B-00-0000-0D0BH430E |
|             | 80      | H2                         | 900       | 30H    | XHP50B-00-0000-0D0HH230H | 30G   | XHP50B-00-0000-0D0HH230G |       |                          |
| 2700 K      | 80      | H2                         | 900       | 27H    | XHP50B-00-0000-0D0HH227H | 27G   | XHP50B-00-0000-0D0HH227G |       |                          |
|             |         | G4                         | 840       | 27H    | XHP50B-00-0000-0D0HG427H | 27G   | XHP50B-00-0000-0D0HG427G |       |                          |

# Mouser Electronics

Authorized Distributor

Click to View Pricing, Inventory, Delivery & Lifecycle Information:

## Cree LED:

[XHP50D-00-0000-0A00J4051](#) [XHP50D-00-0000-0A00J40DT](#) [XHP50D-00-0000-0D00J20CB](#) [XHP50D-00-0000-0D00J20DT](#) [XHP50D-00-0000-0D00J20DV](#) [XHP50D-00-0000-0D00J20E1](#) [XHP50D-00-0000-0D00J20E2](#) [XHP50D-00-0000-0D00J20E3](#) [XHP50D-00-0000-0D00J20E4](#) [XHP50D-00-0000-0D00J20E5](#) [XHP50D-00-0000-0D00J40CB](#) [XHP50D-00-0000-0D00J40DT](#) [XHP50D-00-0000-0D00J40DV](#) [XHP50D-00-0000-0D00J40E1](#) [XHP50D-00-0000-0D00J40E2](#) [XHP50D-00-0000-0D00J40E3](#) [XHP50D-00-0000-0D00J40E4](#) [XHP50D-00-0000-0D00J40E5](#) [XHP50D-00-0000-0D00K20CB](#) [XHP50D-00-0000-0D00K20DT](#) [XHP50D-00-0000-0D00K20DV](#) [XHP50D-00-0000-0D00K20E1](#) [XHP50D-00-0000-0D00K20E2](#) [XHP50D-00-0000-0D00K20E3](#) [XHP50D-00-0000-0D00K20E4](#) [XHP50D-00-0000-0D00K20E5](#) [XHP50D-00-0000-0D0BH40E7](#) [XHP50D-00-0000-0D0BH430E](#) [XHP50D-00-0000-0D0BJ20CB](#) [XHP50D-00-0000-0D0BJ20DT](#) [XHP50D-00-0000-0D0BJ20DV](#) [XHP50D-00-0000-0D0BJ20E1](#) [XHP50D-00-0000-0D0BJ20E2](#) [XHP50D-00-0000-0D0BJ20E3](#) [XHP50D-00-0000-0D0BJ20E4](#) [XHP50D-00-0000-0D0BJ20E5](#) [XHP50D-00-0000-0D0BJ20E6](#) [XHP50D-00-0000-0D0BJ20E7](#) [XHP50D-00-0000-0D0BJ230E](#) [XHP50D-00-0000-0D0BJ235E](#) [XHP50D-00-0000-0D0BJ240E](#) [XHP50D-00-0000-0D0BJ245E](#) [XHP50D-00-0000-0D0BJ250E](#) [XHP50D-00-0000-0D0BJ40CB](#) [XHP50D-00-0000-0D0BJ40DT](#) [XHP50D-00-0000-0D0BJ40DV](#) [XHP50D-00-0000-0D0BJ40E1](#) [XHP50D-00-0000-0D0BJ40E2](#) [XHP50D-00-0000-0D0BJ40E3](#) [XHP50D-00-0000-0D0BJ40E4](#) [XHP50D-00-0000-0D0BJ40E5](#) [XHP50D-00-0000-0D0BJ40E6](#) [XHP50D-00-0000-0D0BJ40E7](#) [XHP50D-00-0000-0D0BJ430E](#) [XHP50D-00-0000-0D0BJ435E](#) [XHP50D-00-0000-0D0BJ440E](#) [XHP50D-00-0000-0D0BJ445E](#) [XHP50D-00-0000-0D0BJ450E](#) [XHP50D-00-0000-0D0BK20CB](#) [XHP50D-00-0000-0D0BK20DT](#) [XHP50D-00-0000-0D0BK20DV](#) [XHP50D-00-0000-0D0BK20E1](#) [XHP50D-00-0000-0D0BK20E2](#) [XHP50D-00-0000-0D0BK20E3](#) [XHP50D-00-0000-0D0BK20E4](#) [XHP50D-00-0000-0D0BK20E5](#) [XHP50D-00-0000-0D0BK20E6](#) [XHP50D-00-0000-0D0BK235E](#) [XHP50D-00-0000-0D0BK240E](#) [XHP50D-00-0000-0D0BK245E](#) [XHP50D-00-0000-0D0BK250E](#) [XHP50D-00-0000-0D0HG427G](#) [XHP50D-00-0000-0D0HG427H](#) [XHP50D-00-0000-0D0HH227G](#) [XHP50D-00-0000-0D0HH227H](#) [XHP50D-00-0000-0D0HH230G](#) [XHP50D-00-0000-0D0HH230H](#) [XHP50D-00-0000-0D0HH235G](#) [XHP50D-00-0000-0D0HH235H](#) [XHP50D-00-0000-0D0HH40CB](#) [XHP50D-00-0000-0D0HH40DT](#) [XHP50D-00-0000-0D0HH40DV](#) [XHP50D-00-0000-0D0HH40E1](#) [XHP50D-00-0000-0D0HH40E2](#) [XHP50D-00-0000-0D0HH40E3](#) [XHP50D-00-0000-0D0HH40E4](#) [XHP50D-00-0000-0D0HH40E5](#) [XHP50D-00-0000-0D0HH427G](#) [XHP50D-00-0000-0D0HH427H](#) [XHP50D-00-0000-0D0HH430G](#) [XHP50D-00-0000-0D0HH430H](#) [XHP50D-00-0000-0D0HH435G](#) [XHP50D-00-0000-0D0HH435H](#) [XHP50D-00-0000-0D0HH440G](#)

[XHP50D-00-0000-0D0HH440H](#) [XHP50D-00-0000-0D0HH445G](#) [XHP50D-00-0000-0D0HH450G](#) [XHP50D-00-0000-0D0HJ20CB](#) [XHP50D-00-0000-0D0HJ20DT](#) [XHP50D-00-0000-0D0HJ20DV](#)