

J Series® 5050 6-V, 9-V, 24-V, 30-V & 36-V LEDs

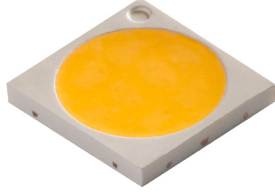

PRODUCT DESCRIPTION

J Series® LEDs extend Cree LED's industry-leading portfolio of lighting-class LEDs to a broader set of applications. The J Series 5050 LEDs deliver high-power light output, high efficacy and excellent value in a reliable package. The J Series 5050 LEDs are optimized for medium-density lighting applications where high efficacy and long lifetime are critical, such as street lights, outdoor area and indoor directional lights.

FEATURES

- Industry-compatible size: 5.0 x 5.0 x 0.7 mm
- 6-V, 9-V, 24-V, 30-V and 36-V configurations
- K Class and P Class LEDs applicable for horticulture applications
- Flux binned at 25 °C, chromaticity binned at 85 °C
- 6500 K–2700 K ANSI CCTs available
- 2200 K CCT available for H class
- 70, 80 & 90 CRI available for all CCTs
- RoHS and REACH compliant
- UL® recognized component (E495478)



J Series® Products are sold exclusively by Cree Venture LED Company Limited ("Cree Venture"), regardless of geography. Any orders for J Series Products that are submitted to Cree LED or any of its other subsidiaries will be directed to Cree Venture for acknowledgment and order fulfillment.

Cree LED / 4001 E. Hwy. 54, Suite 2000 / Durham, NC 27709 USA / +1.919.313.5330 / www.cree-led.com

PRODUCT SUMMARY

Product	Power Class	Test Temperature	Test Current	Typical Forward Voltage	4000 K, 70 CRI		3000 K, 80 CRI		Maximum Current
					Typical Flux	Typical Efficacy	Typical Flux	Typical Efficacy	
JK5050B 6-V H Class	1 W	25 °C	180 mA	5.54 V	223 lm	224 LPW	195 lm	196 LPW	1000 mA
JK5050B 24-V H Class	1 W	25 °C	45 mA	22.16 V	223 lm	224 LPW	195 lm	196 LPW	250 mA
JR5050B 6-V K Class	5 W	25 °C	400 mA	5.67 V	455 lm	201 LPW	404 lm	178 LPW	1000 mA
JR5050B 30-V K Class	5 W	25 °C	80 mA	28.35 V	455 lm	201 LPW	404 lm	178 LPW	240 mA
JR5050 6-V P Class	5 W	25 °C	400 mA	5.77 V	442 lm	192 LPW	394 lm	171 LPW	1000 mA
JR5050 9-V P Class	5 W	25 °C	260 mA	8.56 V	434 lm	195 LPW	383 lm	172 LPW	660 mA
JR5050 24-V P Class	5 W	25 °C	100 mA	23.08 V	442 lm	192 LPW	394 lm	171 LPW	240 mA
JR5050 6-V Q Class	5 W	25 °C	400 mA	5.8 V	425 lm	183 LPW	385 lm	166 LPW	1000 mA
JR5050 9-V Q Class	5 W	25 °C	260 mA	8.6 V	415 lm	186 LPW	372 lm	166 LPW	660 mA
JR5050 24-V Q Class	5 W	25 °C	100 mA	23.5 V	430 lm	183 LPW	385 lm	164 LPW	240 mA
JR5050 36-V Q Class	5 W	25 °C	65 mA	34.5 V	415 lm	185 LPW	372 lm	166 LPW	165 mA

TABLE OF CONTENTS

Order Code & Bin Code Formats	4
JK5050B 6-V H Class.....	5
JK5050B 24-V H Class.....	10
JR5050B 6-V K Class	15
JR5050B 30-V K Class.....	21
JR5050 6-V P Class	27
JR5050 9-V P Class	33
JR5050 24-V P Class	39
JR5050 6-V Q Class	45
JR5050 9-V Q Class	50
JR5050 24-V Q Class.....	55
JR5050 36-V Q Class.....	60
Relative Spectral Power Distribution	65
Typical Spatial Distribution.....	66
Performance Groups - Luminous Flux.....	67
Performance Groups - Forward Voltage.....	68
Performance Groups - Chromaticity.....	69
Reflow Soldering Characteristics.....	78
Notes	79
Mechanical Dimensions	81
Tape & Reel.....	83
Packaging.....	84

ORDER CODE & BIN CODE FORMATS

Order codes and bin codes for J Series 5050 LEDs are configured in the following manner:

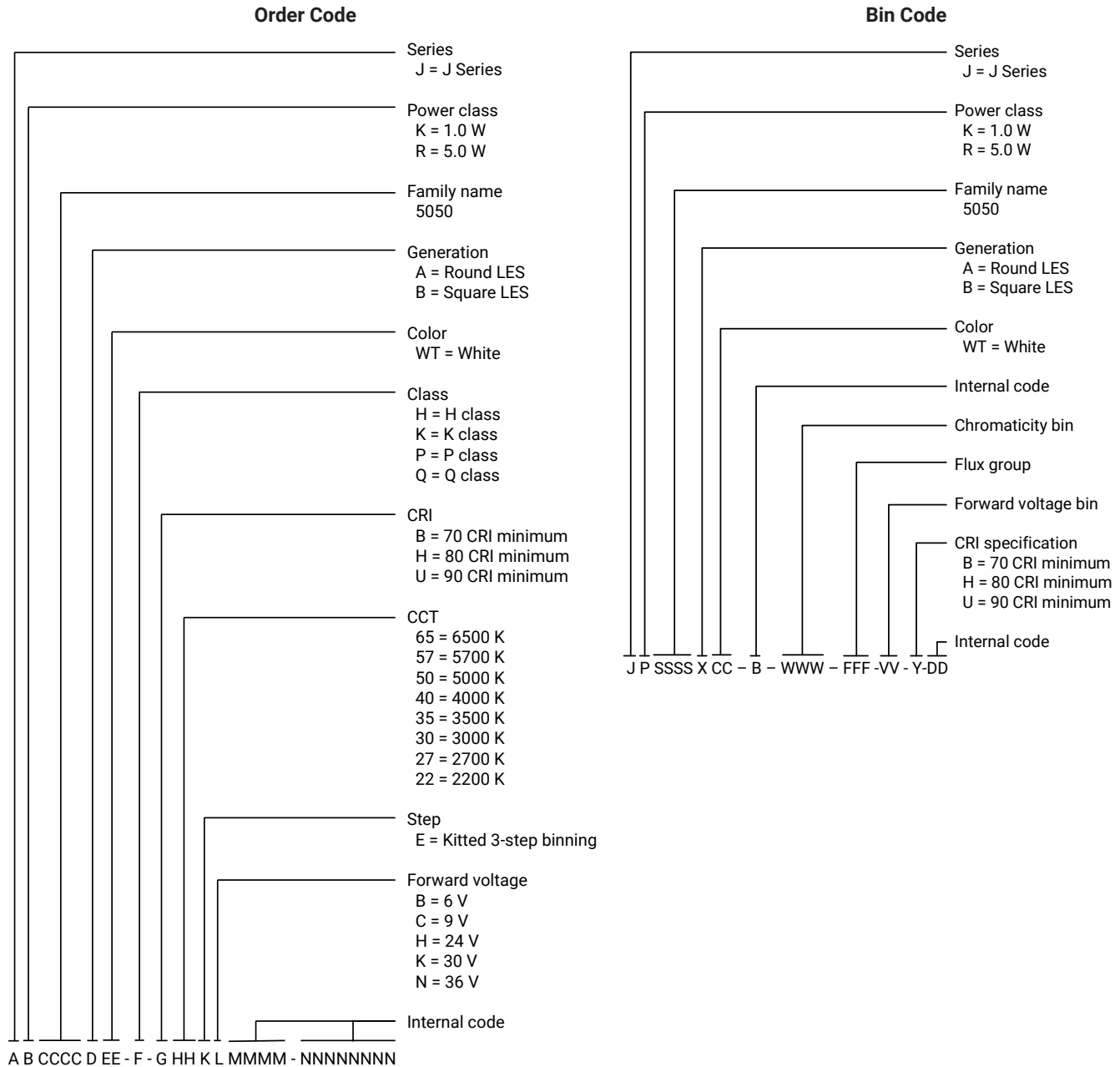

JK5050B 6-V H CLASS

CHARACTERISTICS - JK5050B 6-V H CLASS

Characteristics	Unit	Minimum	Typical	Maximum
Thermal resistance, junction to solder point ^o	°C/W		1.2	
Viewing angle (FWHM)	degrees		120	
Temperature coefficient of voltage	mV/°C		-2.0	
ESD withstand voltage (HBM per Mil-Std-883L)			Class 2	
DC forward current	mA			1000
Reverse voltage	V			5
Forward voltage (@ 180 mA, 25 °C)	V		5.54	5.8
LED junction temperature	°C			125
Operating temperature	°C	-40		105

- Note:
- ◇ Thermal resistance measurement was performed per the JEDEC JESD51-14 standard. See the [Thermal Resistance Measurement application note](#) for more details.
 - Continuous reverse voltage can cause LED damage.

OPERATING LIMITS - JK5050B 6-V H CLASS

The maximum forward current is determined by the thermal resistance between the LED junction and ambient.

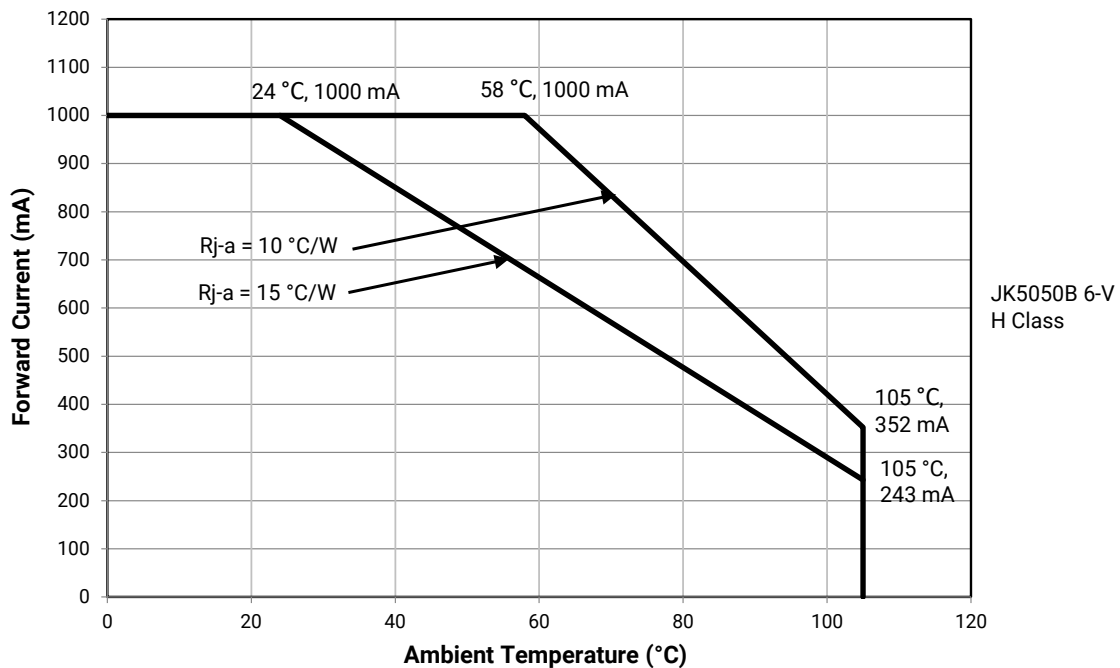

FLUX CHARACTERISTICS, ORDER CODES AND BINS - JK5050B 6-V H CLASS ($I_F = 180 \text{ mA}$, $T_j = 25 \text{ °C}$)

The following table provides order codes for J Series JK5050B 6-V H Class LEDs. For a complete description of the order code nomenclature, please see the Order Code and Bin Code Formats section (page 3). For definitions of the chromaticity kits, please see the Performance Groups - Chromaticity section (page 15).

Nominal CCT	Minimum CRI	Minimum Luminous Flux (lm) @ 25 °C	Typical Luminous Flux (lm) @ 25 °C	Typical Luminous Flux (lm) @ 85 °C*	Kitted 3-Step Order Code**
6500 K	70	210	219	204	JK5050BWT-H-B65EB0000-N0000001
	80	190	203	189	JK5050BWT-H-H65EB0000-N0000001
	90	160	171	159	JK5050BWT-H-U65EB0000-N0000001
5700 K	70	210	223	207	JK5050BWT-H-B57EB0000-N0000001
	80	190	205	191	JK5050BWT-H-H57EB0000-N0000001
	90	160	173	161	JK5050BWT-H-U57EB0000-N0000001
5000 K	70	210	223	207	JK5050BWT-H-B50EB0000-N0000001
	80	190	205	191	JK5050BWT-H-H50EB0000-N0000001
	90	160	173	161	JK5050BWT-H-U50EB0000-N0000001
4000 K	70	210	223	207	JK5050BWT-H-B40EB0000-N0000001
	80	190	205	191	JK5050BWT-H-H40EB0000-N0000001
	90	160	173	161	JK5050BWT-H-U40EB0000-N0000001
3500 K	70	200	214	199	JK5050BWT-H-B35EB0000-N0000001
	80	190	198	184	JK5050BWT-H-H35EB0000-N0000001
	90	160	168	156	JK5050BWT-H-U35EB0000-N0000001
3000 K	70	200	209	194	JK5050BWT-H-B30EB0000-N0000001
	80	180	195	181	JK5050BWT-H-H30EB0000-N0000001
	90	150	165	154	JK5050BWT-H-U30EB0000-N0000001
2700 K	70	190	197	183	JK5050BWT-H-B27EB0000-N0000001
	80	170	185	172	JK5050BWT-H-H27EB0000-N0000001
	90	140	156	145	JK5050BWT-H-U27EB0000-N0000001
2200 K	70	170	177	165	JK5050BWT-H-B22EB0000-N0000001
	80	150	166	154	JK5050BWT-H-H22EB0000-N0000001
	90	130	140	130	JK5050BWT-H-U22EB0000-N0000001

Notes:

- Cree Venture maintains a tolerance of $\pm 7\%$ on flux and power measurements, ± 0.005 on chromaticity (CCx, CCy) measurements and ± 2 on CRI measurements. See the Measurements section (page 79).
- Cree Venture J Series 5050 LED order codes specify only a minimum flux bin and not a maximum. Cree Venture may ship reels in flux bins higher than the minimum specified by the order code without advance notice. Shipments will always adhere to the chromaticity restrictions specified by the order code.
- * Flux values @ 85 °C are calculated and for reference only.
- ** Contact your Cree sales representative for kitted 3-step order code details.

RELATIVE LUMINOUS FLUX VS. CURRENT - JK5050B 6-V H CLASS

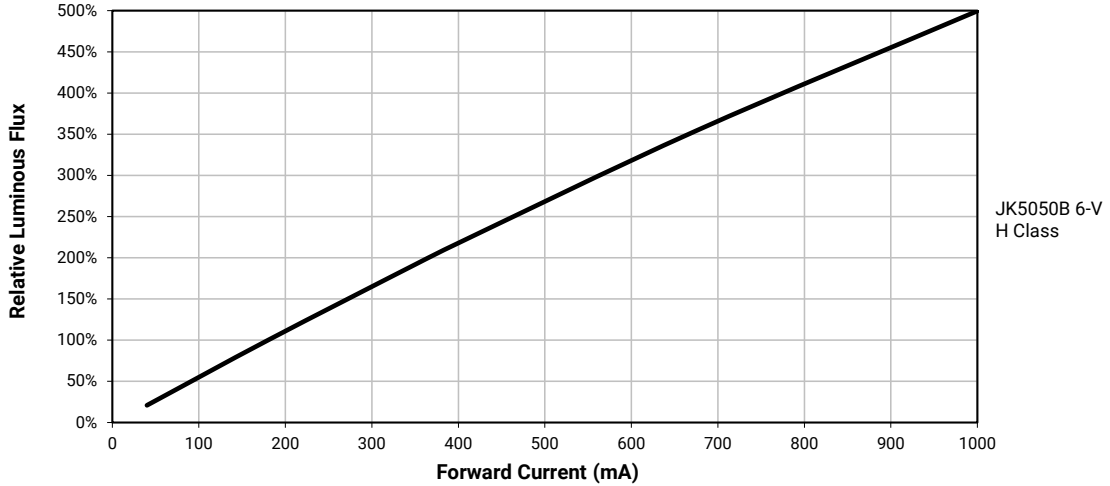

ELECTRICAL CHARACTERISTICS - JK5050B 6-V H CLASS

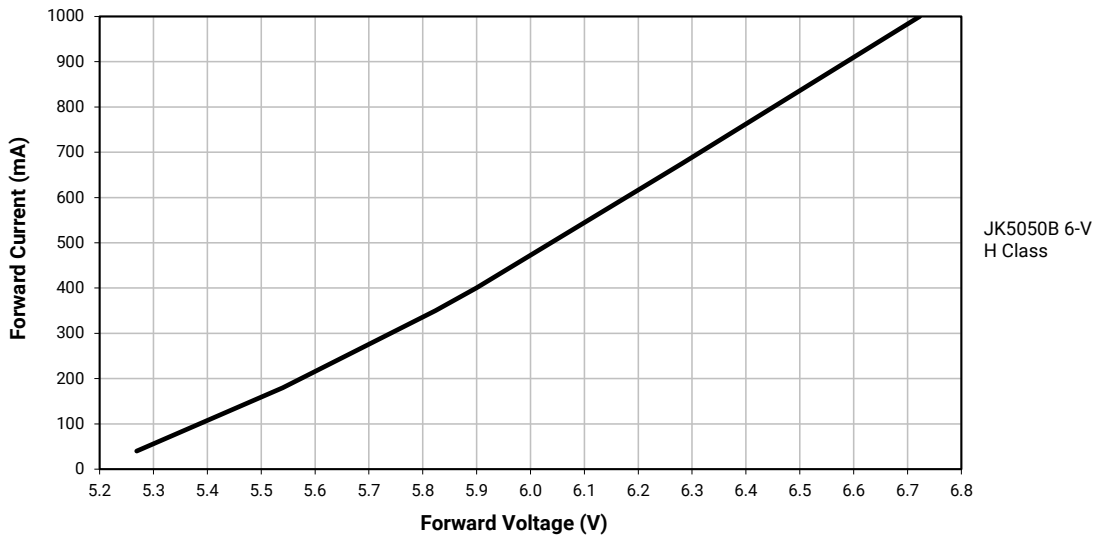

RELATIVE CHROMATICITY VS. CURRENT - JK5050B 6-V H CLASS

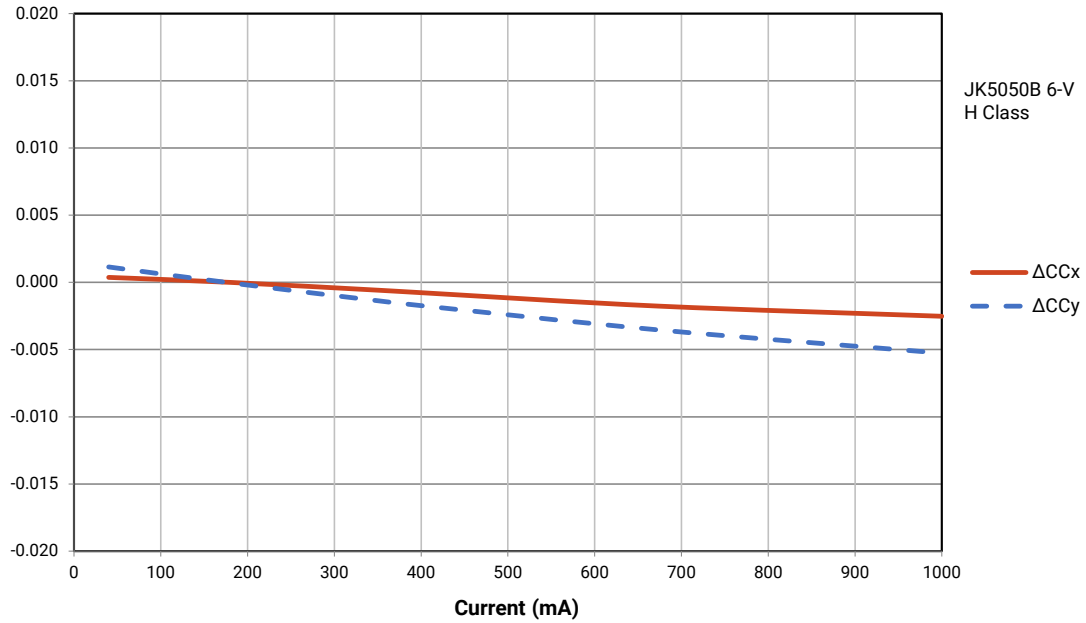

RELATIVE CHROMATICITY VS. TEMPERATURE - JK5050B 6-V H CLASS

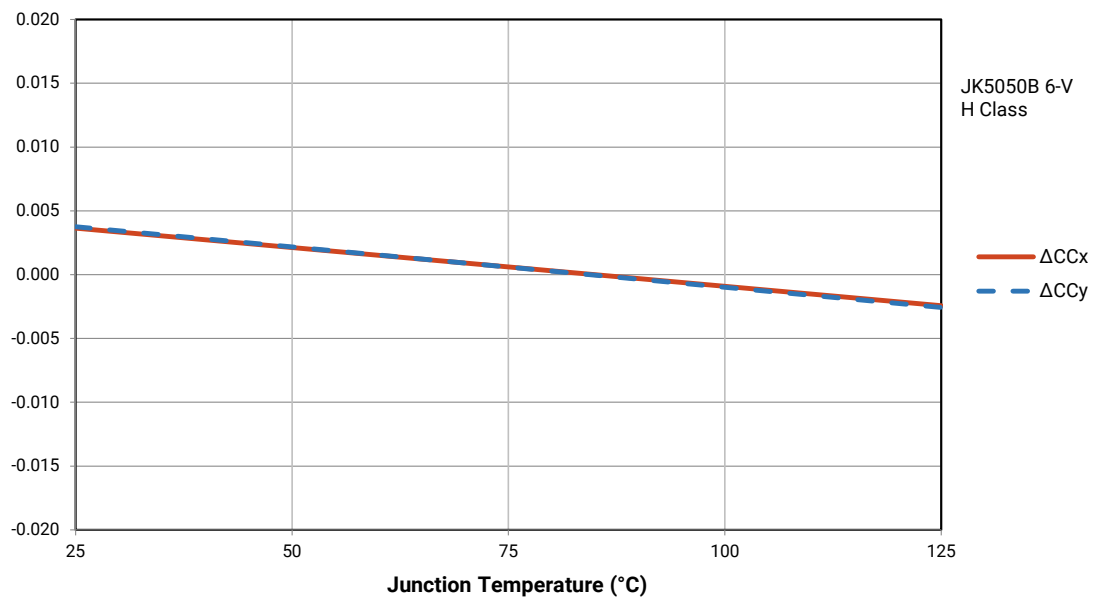

RELATIVE LUMINOUS FLUX VS. JUNCTION TEMPERATURE - JK5050B 6-V H CLASS

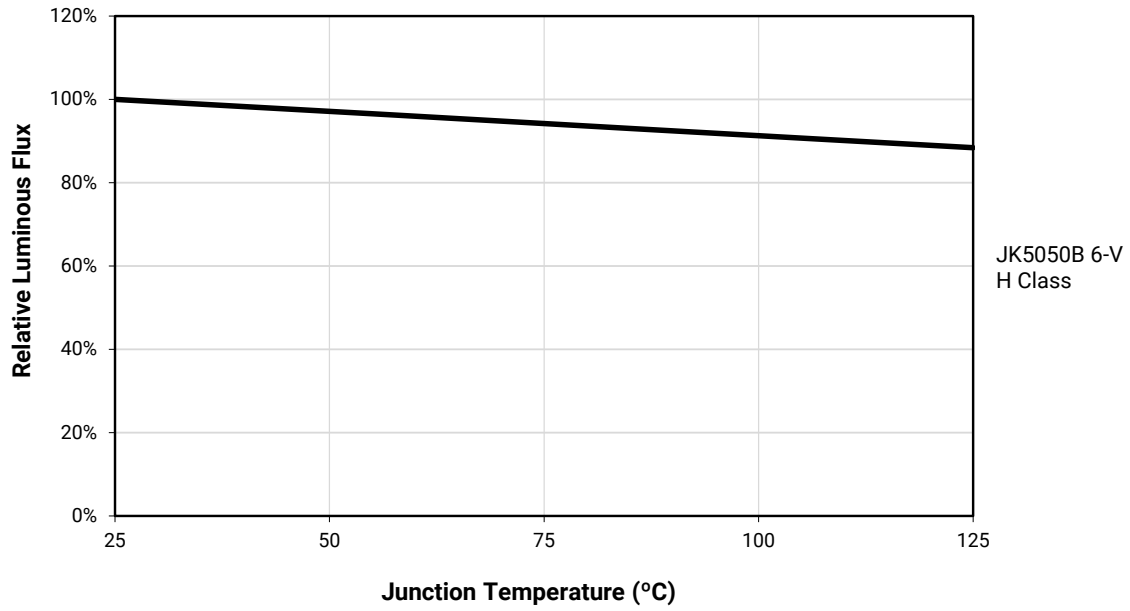

JK5050B 24-V H CLASS

CHARACTERISTICS - JK5050B 24-V H CLASS

Characteristics	Unit	Minimum	Typical	Maximum
Thermal resistance, junction to solder point ^o	°C/W		1.2	
Viewing angle (FWHM)	degrees		120	
Temperature coefficient of voltage	mV/°C		-8.0	
ESD withstand voltage (HBM per Mil-Std-883L)			Class 2	
DC forward current	mA			250
Reverse voltage	V			5
Forward voltage (@ 45 mA, 25 °C)	V		22.16	23.20
LED junction temperature	°C			125
Operating temperature	°C	-40		105

- Note:
- ◇ Thermal resistance measurement was performed per the JEDEC JESD51-14 standard. See the [Thermal Resistance Measurement application note](#) for more details.
 - Continuous reverse voltage can cause LED damage.

OPERATING LIMITS - JK5050B 24-V H CLASS

The maximum forward current is determined by the thermal resistance between the LED junction and ambient.

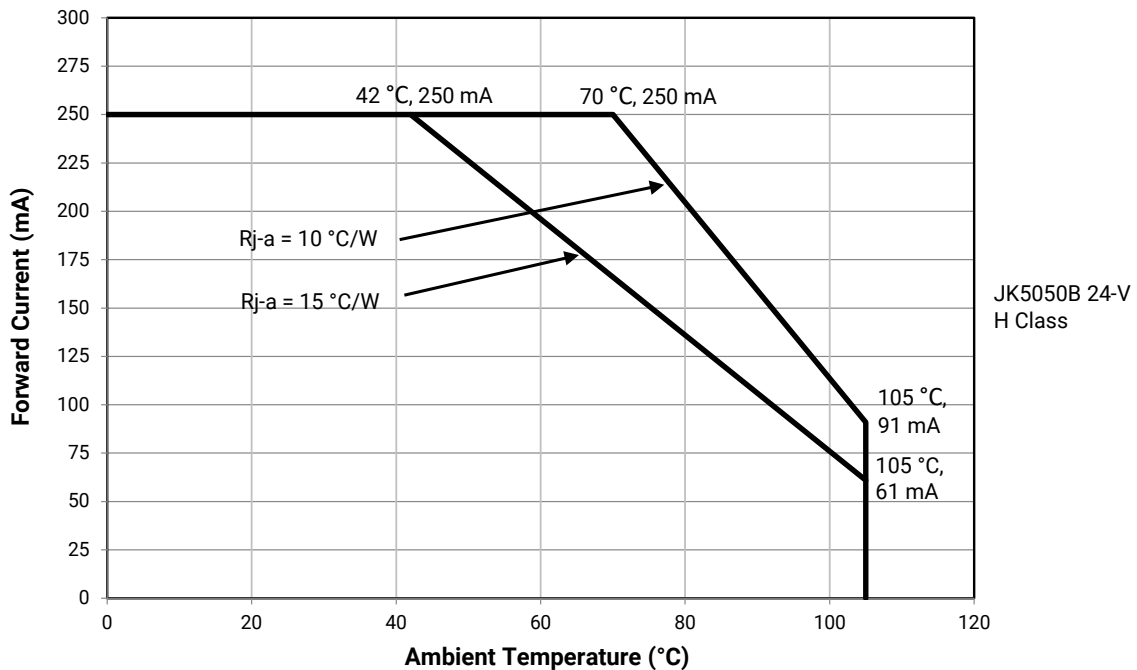

FLUX CHARACTERISTICS, ORDER CODES AND BINS - JK5050B 24-V H CLASS ($I_F = 45 \text{ mA}$, $T_j = 25 \text{ °C}$)

The following table provides order codes for J Series JK5050B 24-V H Class LEDs. For a complete description of the order code nomenclature, please see the Order Code and Bin Code Formats section (page 3). For definitions of the chromaticity kits, please see the Performance Groups - Chromaticity section (page 15).

Nominal CCT	Minimum CRI	Minimum Luminous Flux (lm) @ 25 °C	Typical Luminous Flux (lm) @ 25 °C	Typical Luminous Flux (lm) @ 85 °C*	Kitted 3-Step Order Code**
6500 K	70	210	219	204	JK5050BWT-H-B65EH0000-N0000001
	80	190	203	189	JK5050BWT-H-H65EH0000-N0000001
	90	160	171	159	JK5050BWT-H-U65EH0000-N0000001
5700 K	70	210	223	207	JK5050BWT-H-B57EH0000-N0000001
	80	190	205	191	JK5050BWT-H-H57EH0000-N0000001
	90	160	173	161	JK5050BWT-H-U57EH0000-N0000001
5000 K	70	210	223	207	JK5050BWT-H-B50EH0000-N0000001
	80	190	205	191	JK5050BWT-H-H50EH0000-N0000001
	90	160	173	161	JK5050BWT-H-U50EH0000-N0000001
4000 K	70	210	223	207	JK5050BWT-H-B40EH0000-N0000001
	80	190	205	191	JK5050BWT-H-H40EH0000-N0000001
	90	160	173	161	JK5050BWT-H-U40EH0000-N0000001
3500 K	70	200	214	199	JK5050BWT-H-B35EH0000-N0000001
	80	190	198	184	JK5050BWT-H-H35EH0000-N0000001
	90	160	168	156	JK5050BWT-H-U35EH0000-N0000001
3000 K	70	200	209	194	JK5050BWT-H-B30EH0000-N0000001
	80	180	195	181	JK5050BWT-H-H30EH0000-N0000001
	90	150	165	154	JK5050BWT-H-U30EH0000-N0000001
2700 K	70	190	197	183	JK5050BWT-H-B27EH0000-N0000001
	80	170	185	172	JK5050BWT-H-H27EH0000-N0000001
	90	140	156	145	JK5050BWT-H-U27EH0000-N0000001
2200 K	70	170	177	165	JK5050BWT-H-B22EH0000-N0000001
	80	150	166	154	JK5050BWT-H-H22EH0000-N0000001
	90	130	140	130	JK5050BWT-H-U22EH0000-N0000001

Notes:

- Cree Venture maintains a tolerance of $\pm 7\%$ on flux and power measurements, ± 0.005 on chromaticity (CCx, CCy) measurements and ± 2 on CRI measurements. See the Measurements section (page 79).
- Cree Venture J Series 5050 LED order codes specify only a minimum flux bin and not a maximum. Cree Venture may ship reels in flux bins higher than the minimum specified by the order code without advance notice. Shipments will always adhere to the chromaticity restrictions specified by the order code.
- * Flux values @ 85 °C are calculated and for reference only.
- ** Contact your Cree sales representative for kitted 3-step order code details.

RELATIVE LUMINOUS FLUX VS. CURRENT - JK5050B 24-V H CLASS

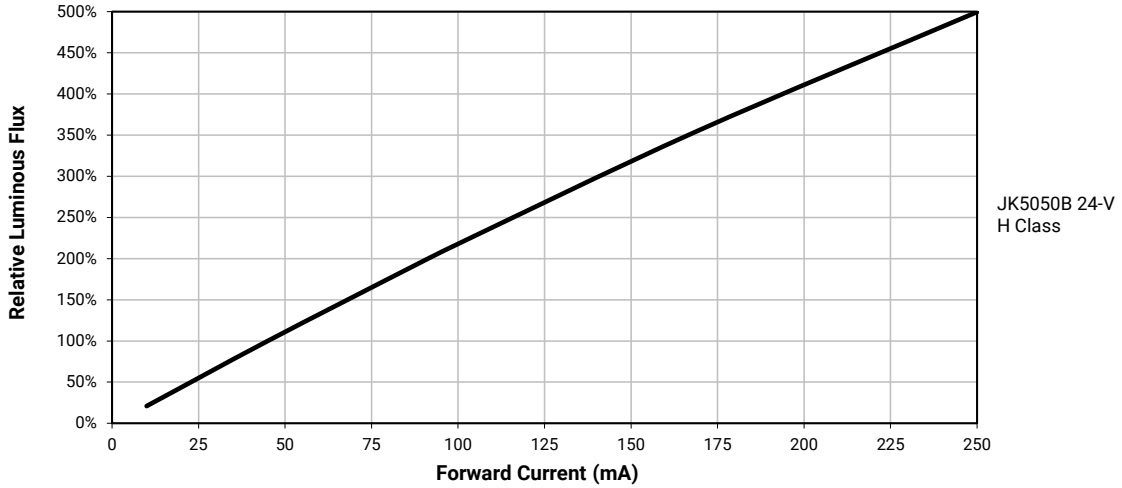

ELECTRICAL CHARACTERISTICS - JK5050B 24-V H CLASS

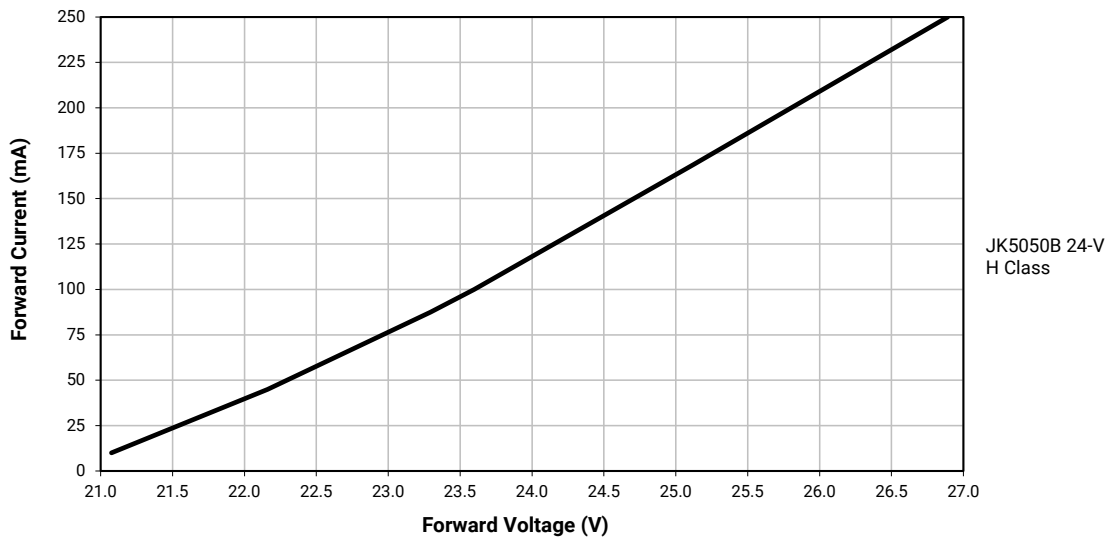

RELATIVE CHROMATICITY VS. CURRENT - JK5050B 24-V H CLASS

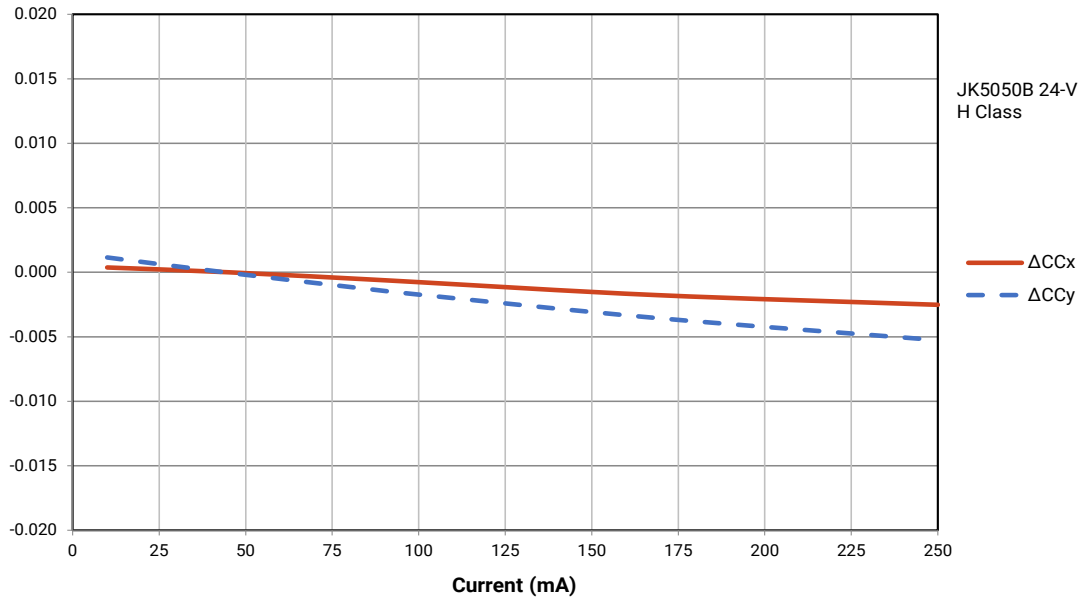

RELATIVE CHROMATICITY VS. TEMPERATURE - JK5050B 24-V H CLASS

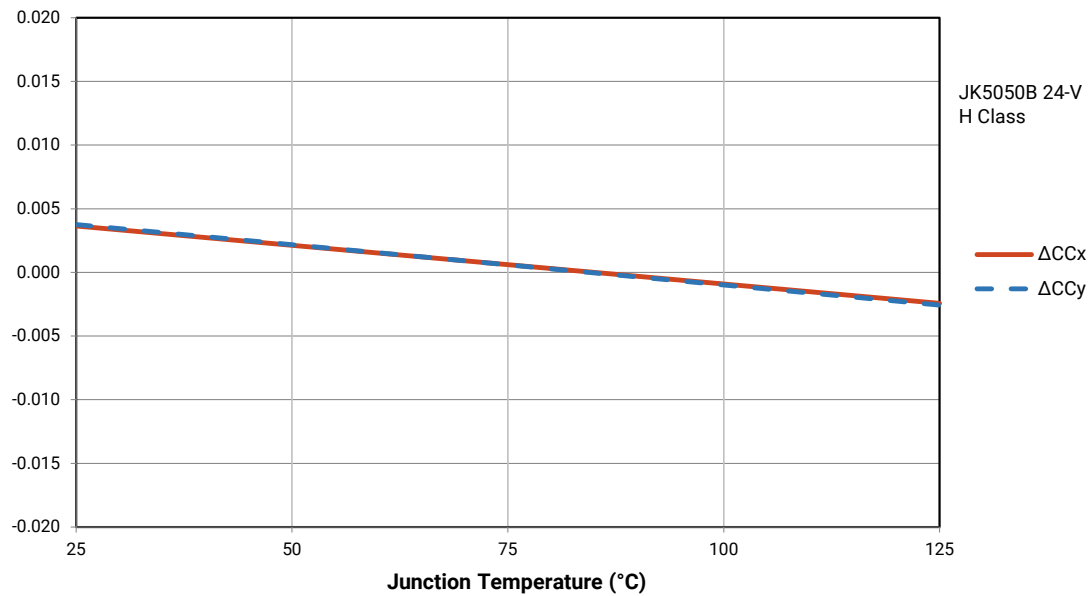

RELATIVE LUMINOUS FLUX VS. JUNCTION TEMPERATURE - JK5050B 24-V H CLASS

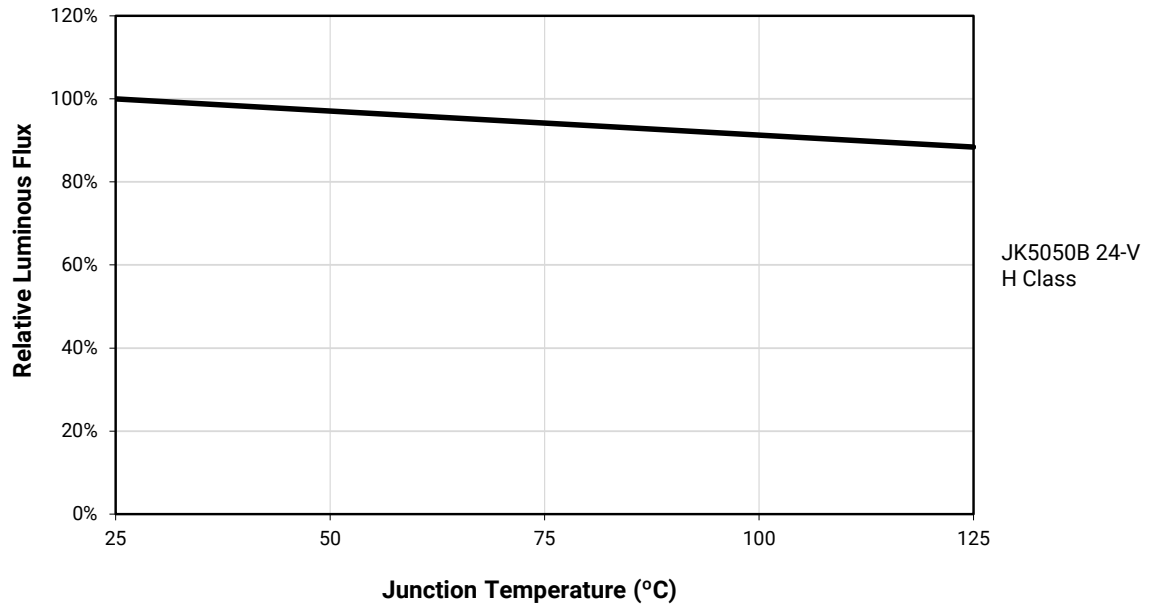

JR5050B 6-V K CLASS

CHARACTERISTICS - JR5050B 6-V K CLASS

Characteristics	Unit	Minimum	Typical	Maximum
Thermal resistance, junction to solder point ^o	°C/W		1.2	
Viewing angle (FWHM)	degrees		120	
Temperature coefficient of voltage	mV/°C		-1.9	
ESD withstand voltage (HBM per Mil-Std-883L)			Class 2	
DC forward current	mA			1000
Reverse voltage	V			5
Forward voltage (@ 400 mA, 25 °C)	V		5.67	6.0
LED junction temperature	°C			125
Operating temperature	°C	-40		105

- Note:
- ◇ Thermal resistance measurement was performed per the JEDEC JESD51-14 standard. See the [Thermal Resistance Measurement application note](#) for more details.
 - Continuous reverse voltage can cause LED damage.

OPERATING LIMITS - JR5050B 6-V K CLASS

The maximum forward current is determined by the thermal resistance between the LED junction and ambient.

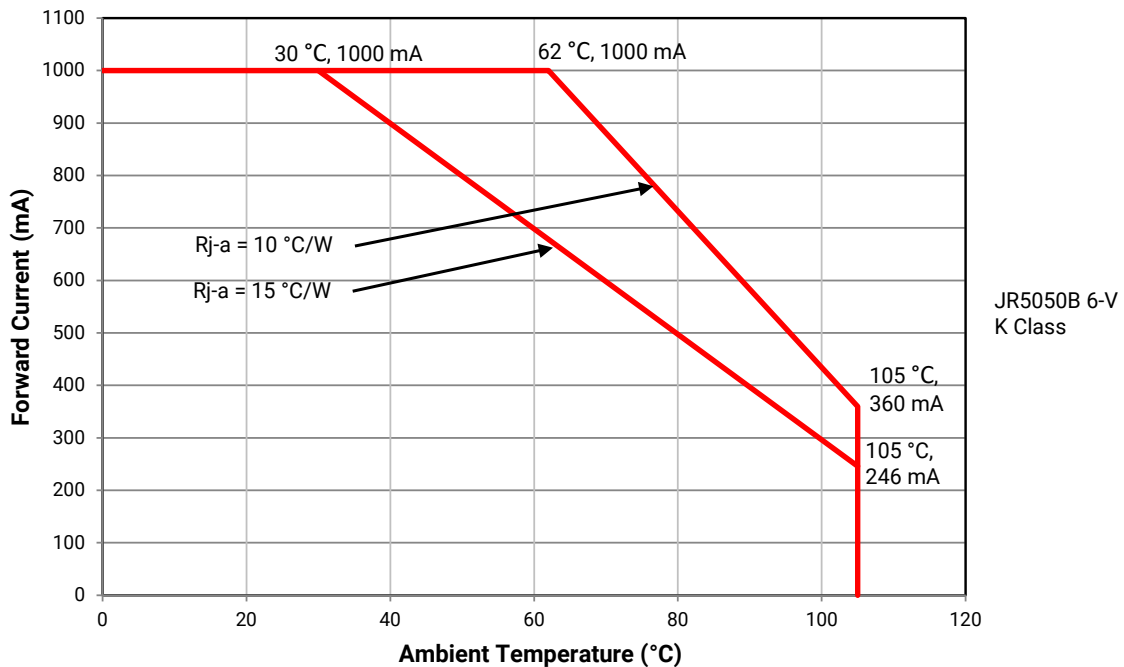

FLUX CHARACTERISTICS, ORDER CODES AND BINS - JR5050B 6-V K CLASS ($I_F = 400 \text{ mA}$, $T_J = 25 \text{ °C}$)

The following table provides order codes for J Series 5050B 6-V K Class LEDs. For a complete description of the order code nomenclature, please see the Order Code and Bin Code Formats section (page 4). For definitions of the chromaticity kits, please see the Performance Groups - Chromaticity section (page 69).

Nominal CCT	Minimum CRI	Minimum Luminous Flux (lm) @ 25 °C	Typical Luminous Flux (lm) @ 25 °C	Typical Luminous Flux (lm) @ 85 °C*	Kitted 3-Step Order Code**
6500 K	70	400	455	421	JR5050BWT-K-B65EB0000-N0000001
	80	350	425	394	JR5050BWT-K-H65EB0000-N0000001
	90	300	357	331	JR5050BWT-K-U65EB0000-N0000001
5700 K	70	400	455	421	JR5050BWT-K-B57EB0000-N0000001
	80	350	425	394	JR5050BWT-K-H57EB0000-N0000001
	90	300	357	331	JR5050BWT-K-U57EB0000-N0000001
5000 K	70	400	455	421	JR5050BWT-K-B50EB0000-N0000001
	80	350	425	394	JR5050BWT-K-H50EB0000-N0000001
	90	300	357	331	JR5050BWT-K-U50EB0000-N0000001
4000 K	70	400	455	421	JR5050BWT-K-B40EB0000-N0000001
	80	350	425	394	JR5050BWT-K-H40EB0000-N0000001
	90	300	357	331	JR5050BWT-K-U40EB0000-N0000001
3500 K	70	400	440	408	JR5050BWT-K-B35EB0000-N0000001
	80	350	415	384	JR5050BWT-K-H35EB0000-N0000001
	90	300	347	321	JR5050BWT-K-U35EB0000-N0000001
3000 K	70	350	433	401	JR5050BWT-K-B30EB0000-N0000001
	80	350	404	374	JR5050BWT-K-H30EB0000-N0000001
	90	300	337	312	JR5050BWT-K-U30EB0000-N0000001
2700 K	70	350	412	382	JR5050BWT-K-B27EB0000-N0000001
	80	350	389	360	JR5050BWT-K-H27EB0000-N0000001
	90	250	327	303	JR5050BWT-K-U27EB0000-N0000001

Notes:

- Cree Venture maintains a tolerance of $\pm 7\%$ on flux and power measurements, ± 0.005 on chromaticity (CCx, CCy) measurements and ± 2 on CRI measurements. See the Measurements section (page 79).
- Cree Venture J Series 5050 LED order codes specify only a minimum flux bin and not a maximum. Cree Venture may ship reels in flux bins higher than the minimum specified by the order code without advance notice. Shipments will always adhere to the chromaticity restrictions specified by the order code.
- * Flux values @ 85 °C are calculated and for reference only.
- ** Contact your Cree sales representative for kitted 3-step order code details.

FLUX CHARACTERISTICS, ORDER CODES AND BINS - JR5050B 6-V K CLASS FOR HORTICULTURE ($I_F = 400 \text{ mA}$, $T_j = 25 \text{ °C}$)

The following table provides order codes for J Series 5050B 6-V K Class LEDs. For a complete description of the order code nomenclature, please see the Order Code and Bin Code Formats section (page 4). For definitions of the chromaticity kits, please see the Performance Groups - Chromaticity section (page 69).

Nominal CCT	Minimum CRI	Minimum Luminous Flux (lm) @ 25 °C	Typical Luminous Flux (lm) @ 25 °C	Typical Luminous Efficacy (lm/W)	PPF* (μmol/s)	PPF/W* (μmol/J)	Kitted 3-Step Order Code**
6500 K	70	400	455	201	6.33	2.79	JR5050BWT-K-B65EB0000-N0000001
	80	350	425	187	6.18	2.72	JR5050BWT-K-H65EB0000-N0000001
	90	300	357	157	5.72	2.52	JR5050BWT-K-U65EB0000-N0000001
5700 K	70	400	455	201	6.13	2.70	JR5050BWT-K-B57EB0000-N0000001
	80	350	425	187	6.04	2.66	JR5050BWT-K-H57EB0000-N0000001
	90	300	357	157	5.56	2.45	JR5050BWT-K-U57EB0000-N0000001
5000 K	70	400	455	201	6.04	2.66	JR5050BWT-K-B50EB0000-N0000001
	80	350	425	187	5.95	2.62	JR5050BWT-K-H50EB0000-N0000001
	90	300	357	157	5.48	2.42	JR5050BWT-K-U50EB0000-N0000001
4000 K	70	400	455	201	6.06	2.67	JR5050BWT-K-B40EB0000-N0000001
	80	350	425	187	5.96	2.63	JR5050BWT-K-H40EB0000-N0000001
	90	300	357	157	5.50	2.42	JR5050BWT-K-U40EB0000-N0000001
3500 K	70	400	440	194	5.95	2.62	JR5050BWT-K-B35EB0000-N0000001
	80	350	415	183	5.91	2.61	JR5050BWT-K-H35EB0000-N0000001
	90	300	347	153	5.42	2.39	JR5050BWT-K-U35EB0000-N0000001
3000 K	70	350	433	191	5.94	2.62	JR5050BWT-K-B30EB0000-N0000001
	80	350	404	178	5.84	2.57	JR5050BWT-K-H30EB0000-N0000001
	90	300	337	149	5.33	2.35	JR5050BWT-K-U30EB0000-N0000001
2700 K	70	350	412	182	5.73	2.53	JR5050BWT-K-B27EB0000-N0000001
	80	350	389	172	5.70	2.51	JR5050BWT-K-H27EB0000-N0000001
	90	250	327	144	5.23	2.31	JR5050BWT-K-U27EB0000-N0000001

Notes:

- Cree Venture maintains a tolerance of ±7% on flux and power measurements, ±0.005 on chromaticity (CCx, CCy) measurements and ±2 on CRI measurements. See the Measurements section (page 79).
- Cree Venture J Series 5050 LED order codes specify only a minimum flux bin and not a maximum. Cree Venture may ship reels in flux bins higher than the minimum specified by the order code without advance notice. Shipments will always adhere to the chromaticity restrictions specified by the order code.
- * PPF values are calculated from luminous flux values and are for reference only.
- ** Contact your Cree LED sales representative for kitted 3-step order code details.

RELATIVE LUMINOUS FLUX VS. CURRENT - JR5050B 6-V K CLASS

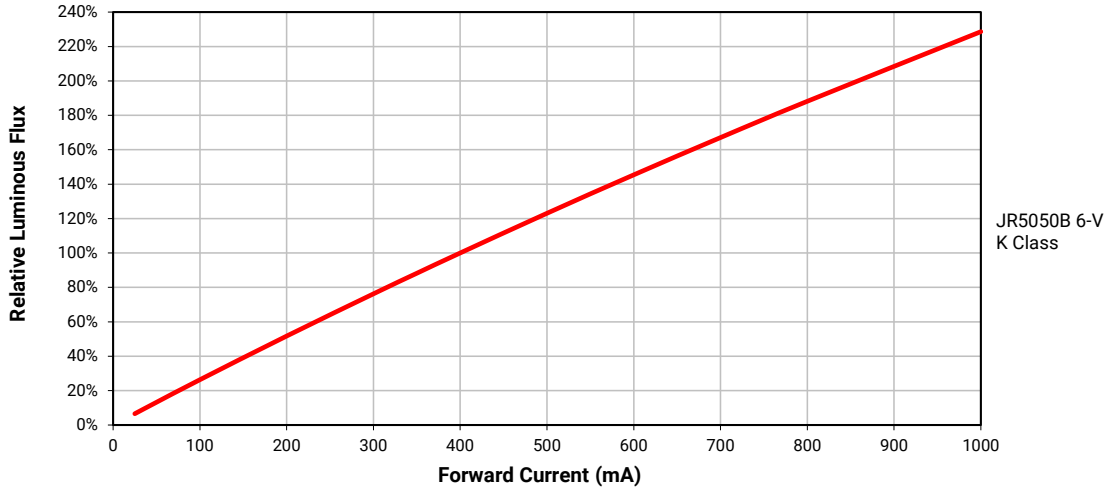

ELECTRICAL CHARACTERISTICS - JR5050B 6-V K CLASS

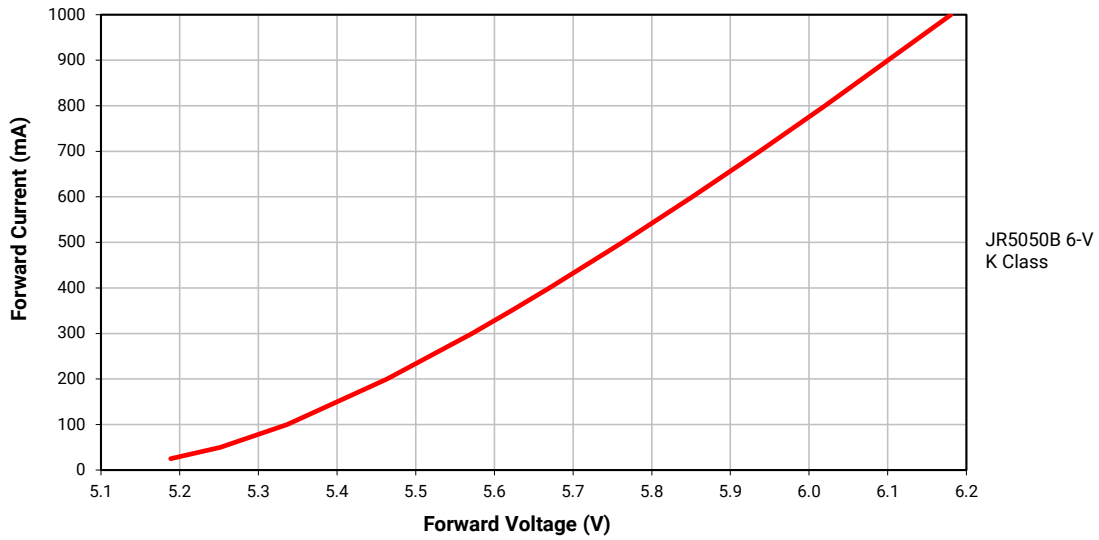

RELATIVE CHROMATICITY VS. CURRENT - JR5050B 6-V K CLASS

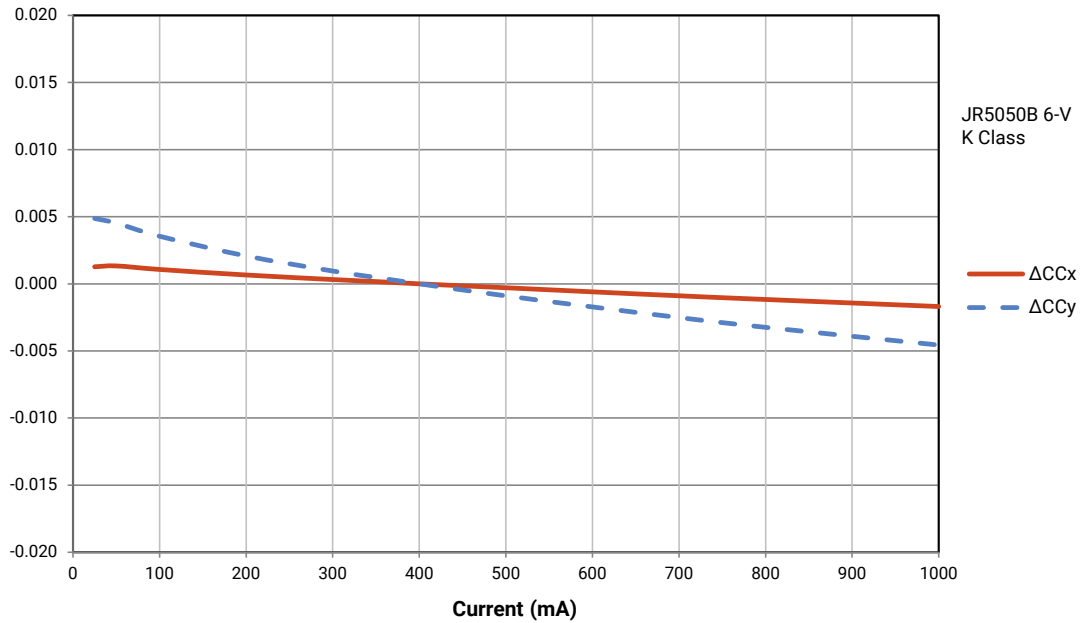

RELATIVE CHROMATICITY VS. TEMPERATURE - JR5050B 6-V K CLASS

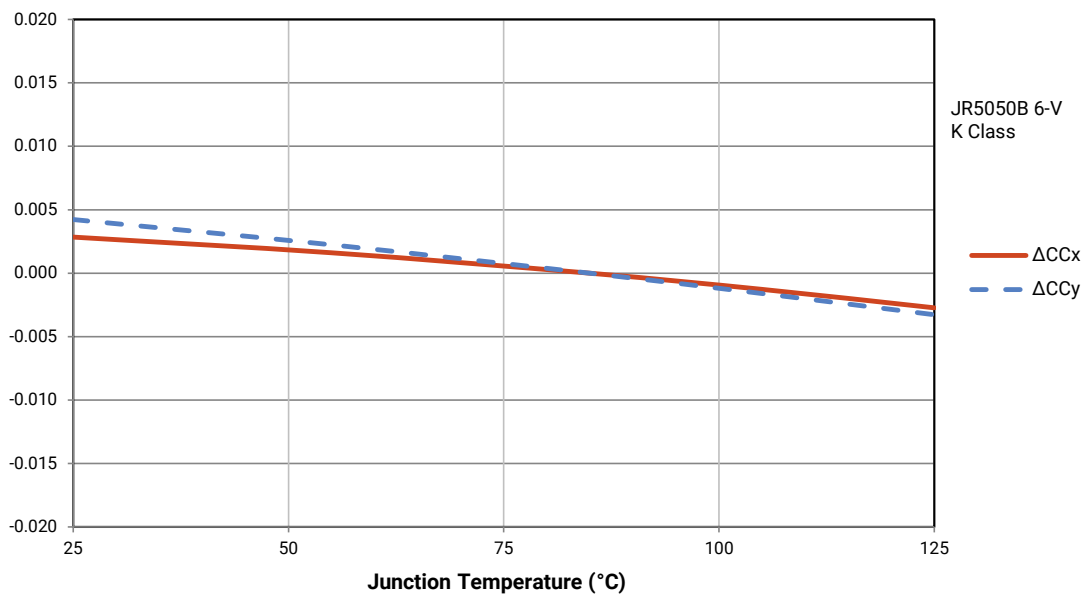

RELATIVE LUMINOUS FLUX VS. JUNCTION TEMPERATURE - JR5050B 6-V K CLASS

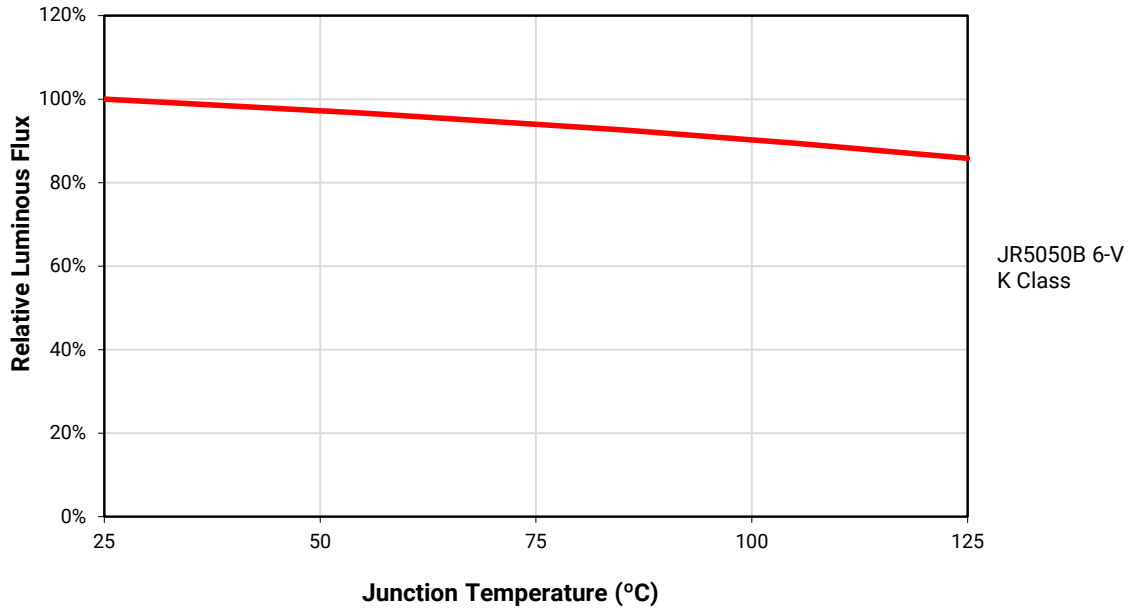

JR5050B 30-V K CLASS

CHARACTERISTICS - JR5050B 30-V K CLASS

Characteristics	Unit	Minimum	Typical	Maximum
Thermal resistance, junction to solder point ^o	°C/W		1.2	
Viewing angle (FWHM)	degrees		120	
Temperature coefficient of voltage	mV/°C		-9.6	
ESD withstand voltage (HBM per Mil-Std-883L)			Class 2	
DC forward current	mA			240
Reverse voltage	V			5
Forward voltage (@ 80 mA, 25 °C)	V		28.35	30.00
LED junction temperature	°C			125
Operating temperature	°C	-40		105

- Note:
- ◇ Thermal resistance measurement was performed per the JEDEC JESD51-14 standard. See the [Thermal Resistance Measurement application note](#) for more details.
 - Continuous reverse voltage can cause LED damage.

OPERATING LIMITS - JR5050B 30-V K CLASS

The maximum forward current is determined by the thermal resistance between the LED junction and ambient.

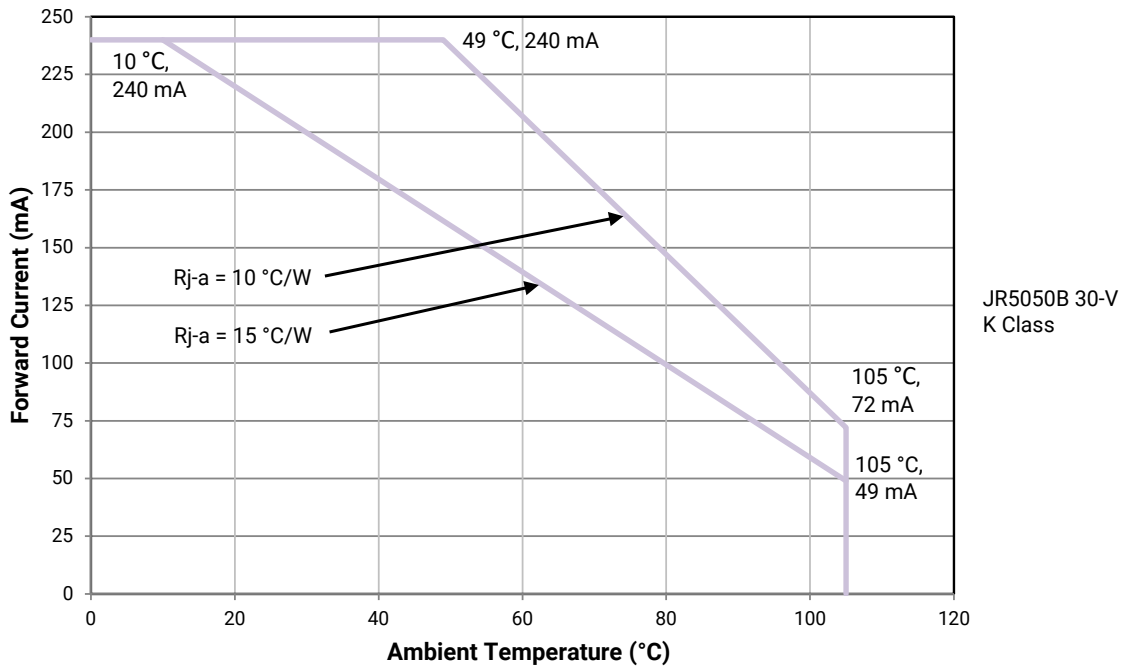

FLUX CHARACTERISTICS, ORDER CODES AND BINS - JR5050B 30-V K CLASS ($I_F = 80 \text{ mA}$, $T_J = 25 \text{ °C}$)

The following table provides order codes for J Series 5050B 30-V K Class LEDs. For a complete description of the order code nomenclature, please see the Order Code and Bin Code Formats section (page 4). For definitions of the chromaticity kits, please see the Performance Groups - Chromaticity section (page 69).

Nominal CCT	Minimum CRI	Minimum Luminous Flux (lm) @ 25 °C	Typical Luminous Flux (lm) @ 25 °C	Typical Luminous Flux (lm) @ 85 °C*	Kitted 3-Step Order Code**
6500 K	70	400	455	421	JR5050BWT-K-B65EK0000-N0000001
	80	350	425	394	JR5050BWT-K-H65EK0000-N0000001
	90	300	357	331	JR5050BWT-K-U65EK0000-N0000001
5700 K	70	400	455	421	JR5050BWT-K-B57EK0000-N0000001
	80	350	425	394	JR5050BWT-K-H57EK0000-N0000001
	90	300	357	331	JR5050BWT-K-U57EK0000-N0000001
5000 K	70	400	455	421	JR5050BWT-K-B50EK0000-N0000001
	80	350	425	394	JR5050BWT-K-H50EK0000-N0000001
	90	300	357	331	JR5050BWT-K-U50EK0000-N0000001
4000 K	70	400	455	421	JR5050BWT-K-B40EK0000-N0000001
	80	350	425	394	JR5050BWT-K-H40EK0000-N0000001
	90	300	357	331	JR5050BWT-K-U40EK0000-N0000001
3500 K	70	400	440	408	JR5050BWT-K-B35EK0000-N0000001
	80	350	415	384	JR5050BWT-K-H35EK0000-N0000001
	90	300	347	321	JR5050BWT-K-U35EK0000-N0000001
3000 K	70	350	433	401	JR5050BWT-K-B30EK0000-N0000001
	80	350	404	374	JR5050BWT-K-H30EK0000-N0000001
	90	300	337	312	JR5050BWT-K-U30EK0000-N0000001
2700 K	70	350	412	382	JR5050BWT-K-B27EK0000-N0000001
	80	350	389	360	JR5050BWT-K-H27EK0000-N0000001
	90	250	327	303	JR5050BWT-K-U27EK0000-N0000001

Notes:

- Cree Venture maintains a tolerance of $\pm 7\%$ on flux and power measurements, ± 0.005 on chromaticity (CCx, CCy) measurements and ± 2 on CRI measurements. See the Measurements section (page 79).
- Cree Venture J Series 5050 LED order codes specify only a minimum flux bin and not a maximum. Cree Venture may ship reels in flux bins higher than the minimum specified by the order code without advance notice. Shipments will always adhere to the chromaticity restrictions specified by the order code.
- * Flux values @ 85 °C are calculated and for reference only.
- ** Contact your Cree sales representative for kitted 3-step order code details.

FLUX CHARACTERISTICS, ORDER CODES AND BINS - JR5050B 30-V K CLASS FOR HORTICULTURE (I_F = 80 mA, T_J = 25 °C)

The following table provides order codes for J Series 5050B 30-V K Class LEDs. For a complete description of the order code nomenclature, please see the Order Code and Bin Code Formats section (page 4). For definitions of the chromaticity kits, please see the Performance Groups - Chromaticity section (page 69).

Nominal CCT	Minimum CRI	Minimum Luminous Flux (lm) @ 25 °C	Typical Luminous Flux (lm) @ 25 °C	Typical Luminous Efficacy (lm/W)	PPF* (μmol/s)	PPF/W* (μmol/J)	Kitted 3-Step Order Code**
6500 K	70	400	455	201	6.33	2.79	JR5050BWT-K-B65EK0000-N0000001
	80	350	425	187	6.18	2.72	JR5050BWT-K-H65EK0000-N0000001
	90	300	357	157	5.72	2.52	JR5050BWT-K-U65EK0000-N0000001
5700 K	70	400	455	201	6.13	2.70	JR5050BWT-K-B57EK0000-N0000001
	80	350	425	187	6.04	2.66	JR5050BWT-K-H57EK0000-N0000001
	90	300	357	157	5.56	2.45	JR5050BWT-K-U57EK0000-N0000001
5000 K	70	400	455	201	6.04	2.66	JR5050BWT-K-B50EK0000-N0000001
	80	350	425	187	5.95	2.62	JR5050BWT-K-H50EK0000-N0000001
	90	300	357	157	5.48	2.42	JR5050BWT-K-U50EK0000-N0000001
4000 K	70	400	455	201	6.06	2.67	JR5050BWT-K-B40EK0000-N0000001
	80	350	425	187	5.96	2.63	JR5050BWT-K-H40EK0000-N0000001
	90	300	357	157	5.50	2.42	JR5050BWT-K-U40EK0000-N0000001
3500 K	70	400	440	194	5.95	2.62	JR5050BWT-K-B35EK0000-N0000001
	80	350	415	183	5.91	2.61	JR5050BWT-K-H35EK0000-N0000001
	90	300	347	153	5.42	2.39	JR5050BWT-K-U35EK0000-N0000001
3000 K	70	350	433	191	5.94	2.62	JR5050BWT-K-B30EK0000-N0000001
	80	350	404	178	5.84	2.57	JR5050BWT-K-H30EK0000-N0000001
	90	300	337	149	5.33	2.35	JR5050BWT-K-U30EK0000-N0000001
2700 K	70	350	412	182	5.73	2.53	JR5050BWT-K-B27EK0000-N0000001
	80	350	389	172	5.70	2.51	JR5050BWT-K-H27EK0000-N0000001
	90	250	327	144	5.23	2.31	JR5050BWT-K-U27EK0000-N0000001

Notes:

- Cree Venture maintains a tolerance of ±7% on flux and power measurements, ±0.005 on chromaticity (CCx, CCy) measurements and ±2 on CRI measurements. See the Measurements section (page 79).
- Cree Venture J Series 5050 LED order codes specify only a minimum flux bin and not a maximum. Cree Venture may ship reels in flux bins higher than the minimum specified by the order code without advance notice. Shipments will always adhere to the chromaticity restrictions specified by the order code.
- * PPF values are calculated from luminous flux values and are for reference only.
- ** Contact your Cree LED sales representative for kitted 3-step order code details.

RELATIVE LUMINOUS FLUX VS. CURRENT - JR5050B 30-V K CLASS

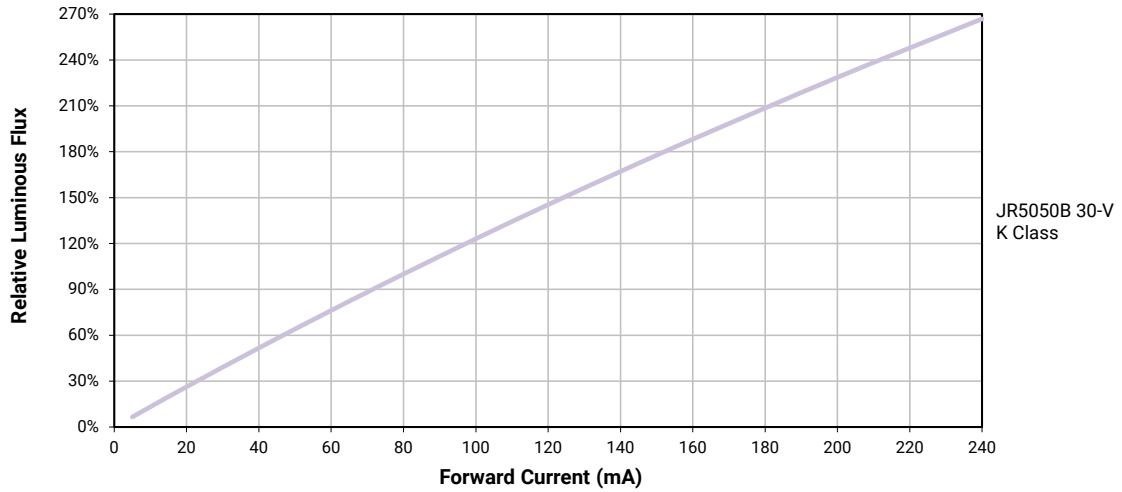

ELECTRICAL CHARACTERISTICS - JR5050B 30-V K CLASS

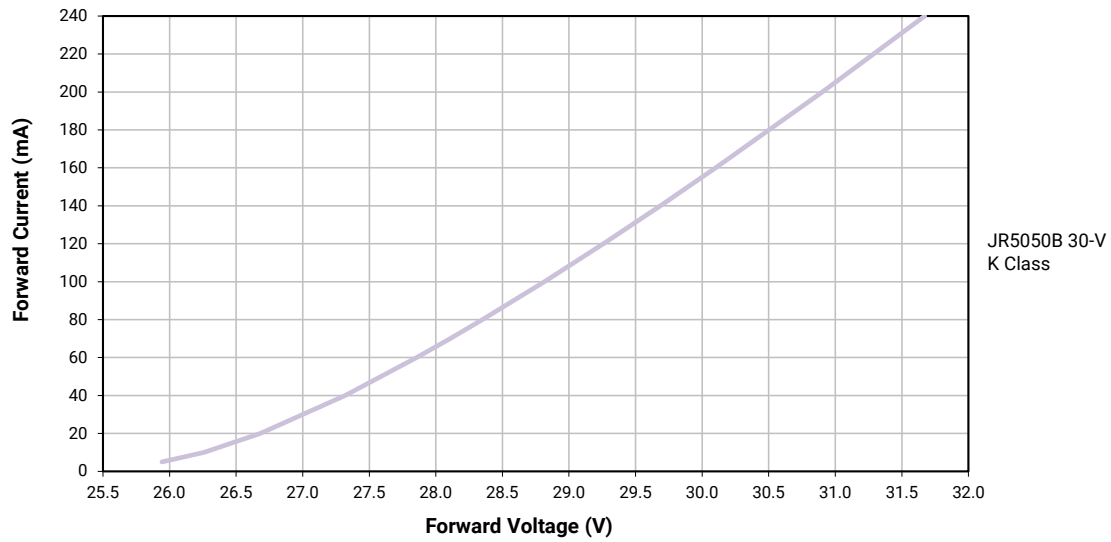

RELATIVE CHROMATICITY VS. CURRENT - JR5050B 30-V K CLASS

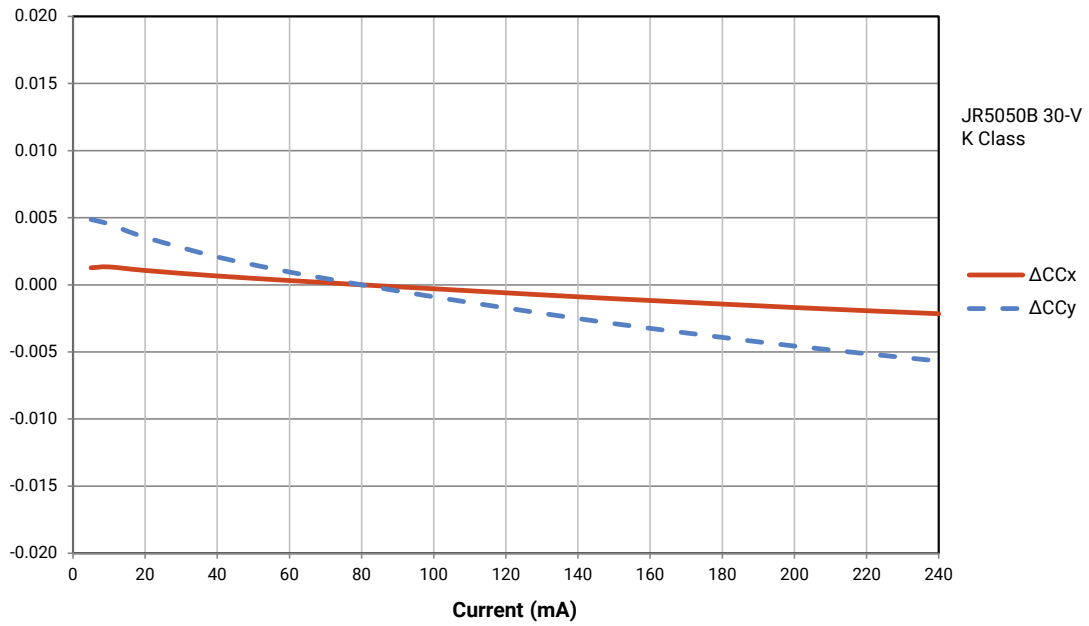

RELATIVE CHROMATICITY VS. TEMPERATURE - JR5050B 30-V K CLASS

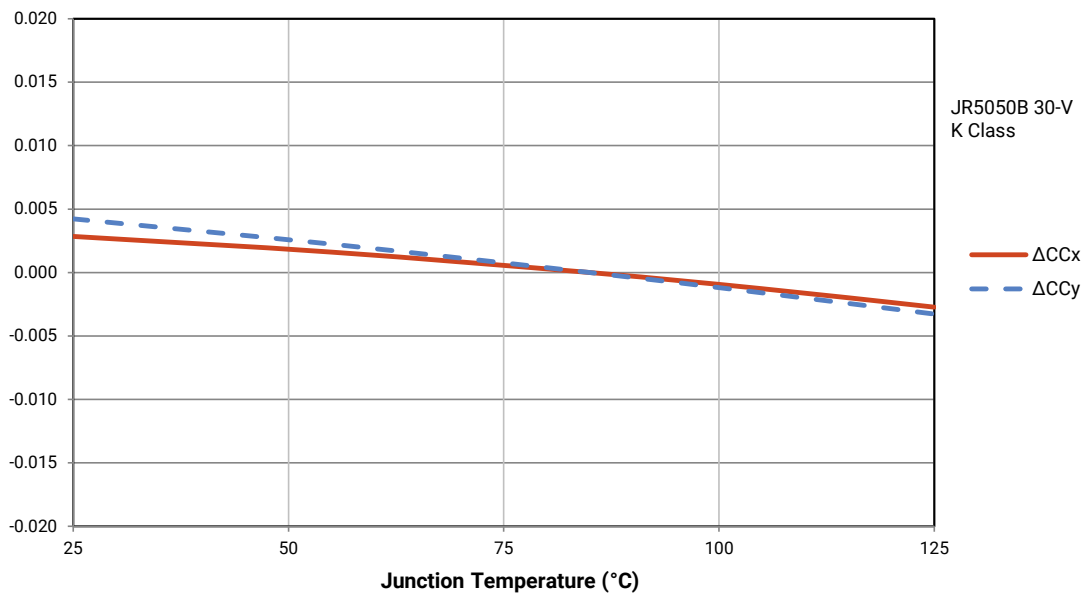

RELATIVE LUMINOUS FLUX VS. JUNCTION TEMPERATURE - JR5050B 30-V K CLASS

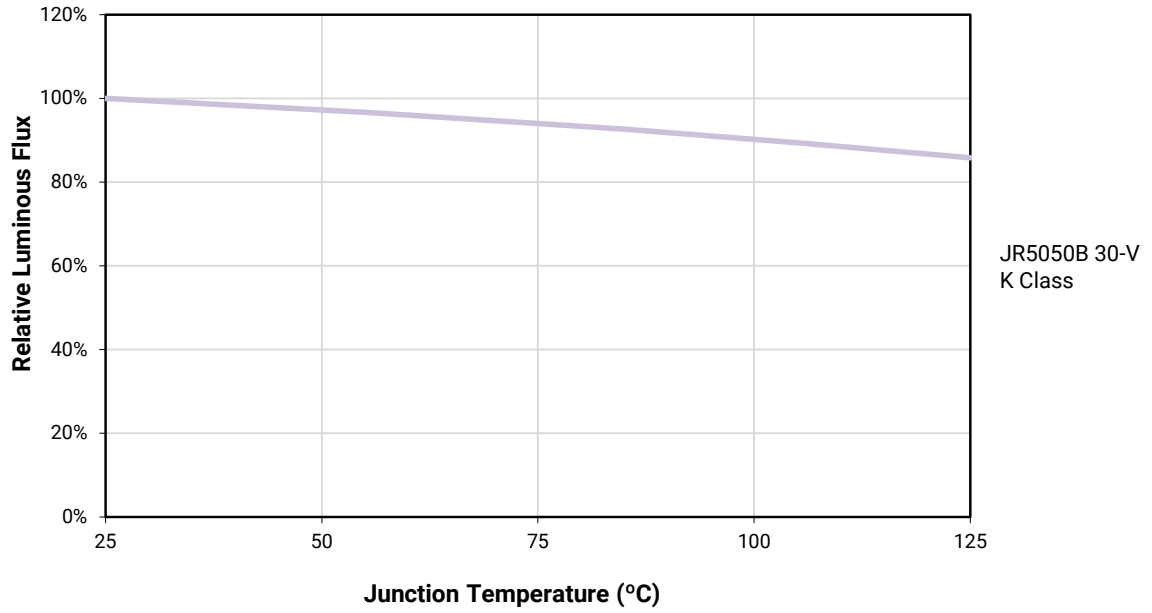

JR5050 6-V P CLASS

CHARACTERISTICS - JR5050 6-V P CLASS

Characteristics	Unit	Minimum	Typical	Maximum
Thermal resistance, junction to solder point ^o	°C/W		1.2	
Viewing angle (FWHM)	degrees		120	
Temperature coefficient of voltage	mV/°C		-1.8	
ESD withstand voltage (HBM per Mil-Std-883L)			Class 2	
DC forward current	mA			1000
Reverse voltage	V			5
Forward voltage (@ 400 mA, 25 °C)	V		5.77	6.0
LED junction temperature	°C			125
Operating temperature	°C	-40		105

- Note:
- ◊ Thermal resistance measurement was performed per the JEDEC JESD51-14 standard. See the [Thermal Resistance Measurement application note](#) for more details.
 - Continuous reverse voltage can cause LED damage.

OPERATING LIMITS - JR5050 6-V P CLASS

The maximum forward current is determined by the thermal resistance between the LED junction and ambient.

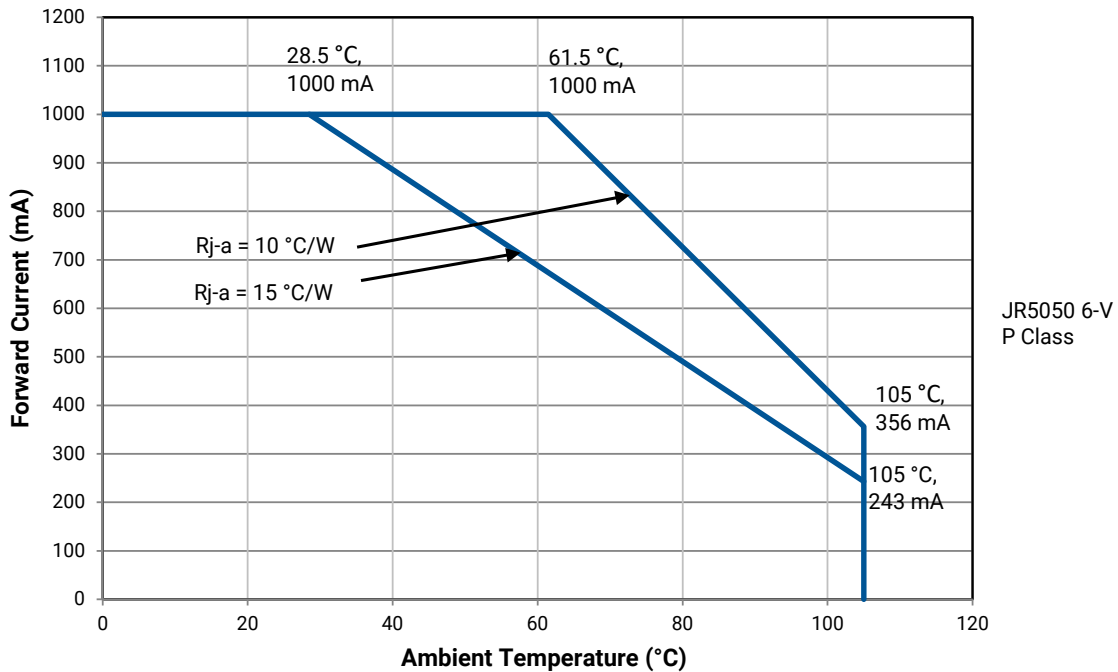

FLUX CHARACTERISTICS, ORDER CODES AND BINS - JR5050 6-V P CLASS ($I_F = 400\text{ mA}$, $T_j = 25\text{ °C}$)

The following table provides order codes for J Series 5050 6-V P Class LEDs. For a complete description of the order code nomenclature, please see the Order Code and Bin Code Formats section (page 4). For definitions of the chromaticity kits, please see the Performance Groups - Chromaticity section (page 69).

Nominal CCT	Minimum CRI	Minimum Luminous Flux (lm) @ 25 °C	Typical Luminous Flux (lm) @ 25 °C	Typical Luminous Flux (lm) @ 85 °C*	Kitted 3-Step Order Code**
6500 K	70	400	442	405	JR5050AWT-P-B65EB0000-N0000001
	80	350	414	380	JR5050AWT-P-H65EB0000-N0000001
	90	300	351	322	JR5050AWT-P-U65EB0000-N0000001
5700 K	70	400	442	405	JR5050AWT-P-B57EB0000-N0000001
	80	350	414	380	JR5050AWT-P-H57EB0000-N0000001
	90	300	351	322	JR5050AWT-P-U57EB0000-N0000001
5000 K	70	400	442	405	JR5050AWT-P-B50EB0000-N0000001
	80	350	414	380	JR5050AWT-P-H50EB0000-N0000001
	90	300	351	322	JR5050AWT-P-U50EB0000-N0000001
4000 K	70	400	442	405	JR5050AWT-P-B40EB0000-N0000001
	80	350	414	380	JR5050AWT-P-H40EB0000-N0000001
	90	300	351	322	JR5050AWT-P-U40EB0000-N0000001
3500 K	70	350	427	392	JR5050AWT-P-B35EB0000-N0000001
	80	350	404	371	JR5050AWT-P-H35EB0000-N0000001
	90	300	341	313	JR5050AWT-P-U35EB0000-N0000001
3000 K	70	350	417	383	JR5050AWT-P-B30EB0000-N0000001
	80	350	394	361	JR5050AWT-P-H30EB0000-N0000001
	90	300	331	304	JR5050AWT-P-U30EB0000-N0000001
2700 K	70	350	402	369	JR5050AWT-P-B27EB0000-N0000001
	80	350	379	348	JR5050AWT-P-H27EB0000-N0000001
	90	250	321	294	JR5050AWT-P-U27EB0000-N0000001

Notes:

- Cree Venture maintains a tolerance of $\pm 7\%$ on flux and power measurements, ± 0.005 on chromaticity (CCx, CCy) measurements and ± 2 on CRI measurements. See the Measurements section (page 79).
- Cree Venture J Series 5050 LED order codes specify only a minimum flux bin and not a maximum. Cree Venture may ship reels in flux bins higher than the minimum specified by the order code without advance notice. Shipments will always adhere to the chromaticity restrictions specified by the order code.
- * Flux values @ 85 °C are calculated and for reference only.
- ** Contact your Cree sales representative for kitted 3-step order code details.

FLUX CHARACTERISTICS, ORDER CODES AND BINS - JR5050 6-V P CLASS FOR HORTICULTURE (I_F = 400 mA, T_J = 25 °C)

The following table provides order codes for J Series 5050 6-V P Class LEDs. For a complete description of the order code nomenclature, please see the Order Code and Bin Code Formats section (page 4). For definitions of the chromaticity kits, please see the Performance Groups - Chromaticity section (page 69).

Nominal CCT	Minimum CRI	Minimum Luminous Flux (lm) @ 25 °C	Typical Luminous Flux (lm) @ 25 °C	Typical Luminous Efficacy (lm/W)	PPF* (μmol/s)	PPF/W* (μmol/J)	Kitted 3-Step Order Code**
6500 K	70	400	442	192	6.15	2.67	JR5050AWT-P-B65EB0000-N0000001
	80	350	414	179	6.02	2.61	JR5050AWT-P-H65EB0000-N0000001
	90	300	351	152	5.62	2.43	JR5050AWT-P-U65EB0000-N0000001
5700 K	70	400	442	192	5.96	2.58	JR5050AWT-P-B57EB0000-N0000001
	80	350	414	179	5.88	2.55	JR5050AWT-P-H57EB0000-N0000001
	90	300	351	152	5.47	2.37	JR5050AWT-P-U57EB0000-N0000001
5000 K	70	400	442	192	5.86	2.54	JR5050AWT-P-B50EB0000-N0000001
	80	350	414	179	5.79	2.51	JR5050AWT-P-H50EB0000-N0000001
	90	300	351	152	5.39	2.34	JR5050AWT-P-U50EB0000-N0000001
4000 K	70	400	442	192	5.88	2.55	JR5050AWT-P-B40EB0000-N0000001
	80	350	414	179	5.81	2.52	JR5050AWT-P-H40EB0000-N0000001
	90	300	351	152	5.41	2.34	JR5050AWT-P-U40EB0000-N0000001
3500 K	70	350	427	185	5.77	2.50	JR5050AWT-P-B35EB0000-N0000001
	80	350	404	175	5.75	2.49	JR5050AWT-P-H35EB0000-N0000001
	90	300	341	148	5.32	2.31	JR5050AWT-P-U35EB0000-N0000001
3000 K	70	350	417	181	5.72	2.48	JR5050AWT-P-B30EB0000-N0000001
	80	350	394	171	5.69	2.47	JR5050AWT-P-H30EB0000-N0000001
	90	300	331	143	5.24	2.27	JR5050AWT-P-U30EB0000-N0000001
2700 K	70	350	402	174	5.59	2.42	JR5050AWT-P-B27EB0000-N0000001
	80	350	379	164	5.55	2.40	JR5050AWT-P-H27EB0000-N0000001
	90	250	321	139	5.14	2.23	JR5050AWT-P-U27EB0000-N0000001

Notes:

- Cree Venture maintains a tolerance of ±7% on flux and power measurements, ±0.005 on chromaticity (CCx, CCy) measurements and ±2 on CRI measurements. See the Measurements section (page 79).
- Cree Venture J Series 5050 LED order codes specify only a minimum flux bin and not a maximum. Cree Venture may ship reels in flux bins higher than the minimum specified by the order code without advance notice. Shipments will always adhere to the chromaticity restrictions specified by the order code.
- * PPF values are calculated from luminous flux values and are for reference only.
- ** Contact your Cree LED sales representative for kitted 3-step order code details.

RELATIVE LUMINOUS FLUX VS. CURRENT - JR5050 6-V P CLASS

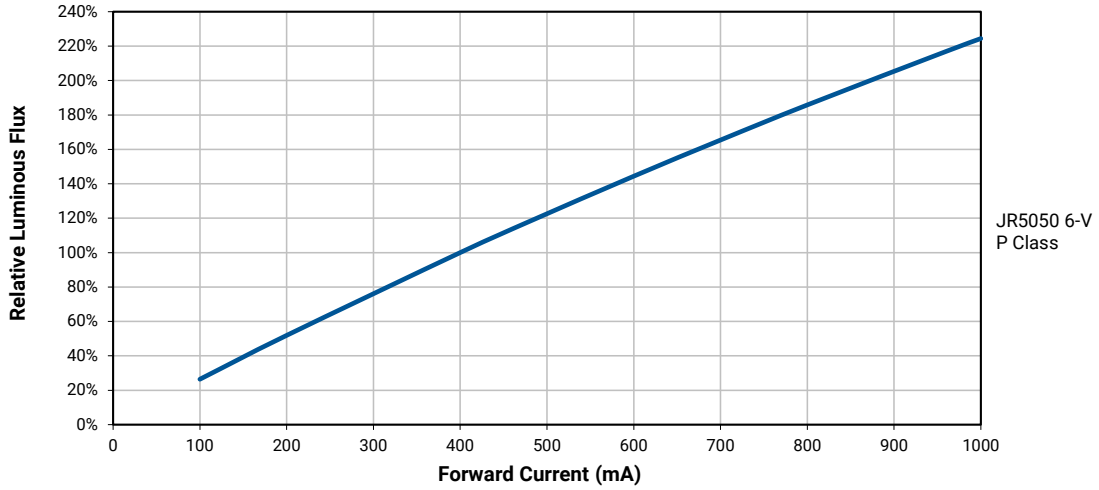

ELECTRICAL CHARACTERISTICS - JR5050 6-V P CLASS

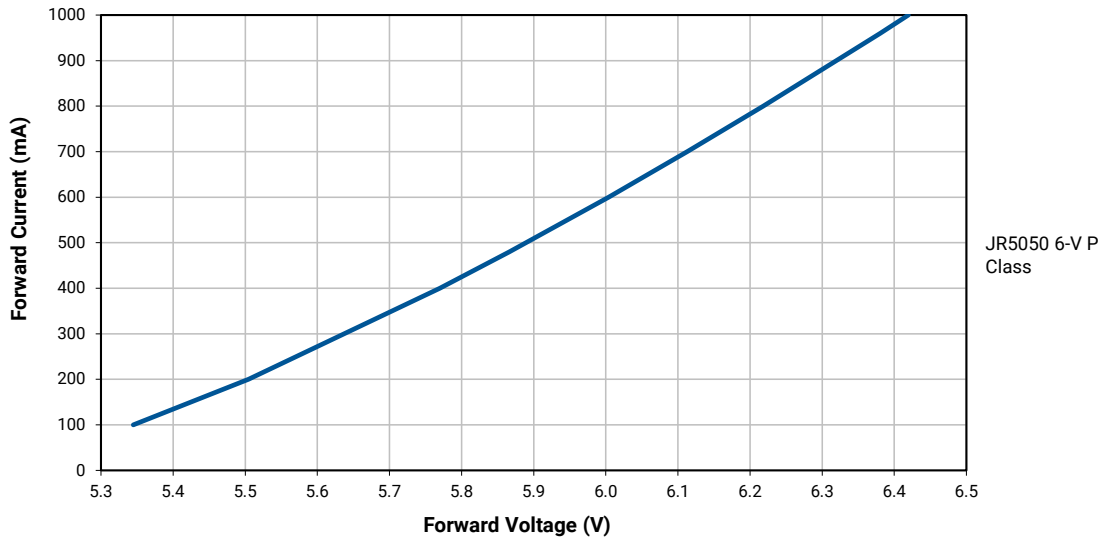

RELATIVE CHROMATICITY VS. CURRENT - JR5050 6-V P CLASS

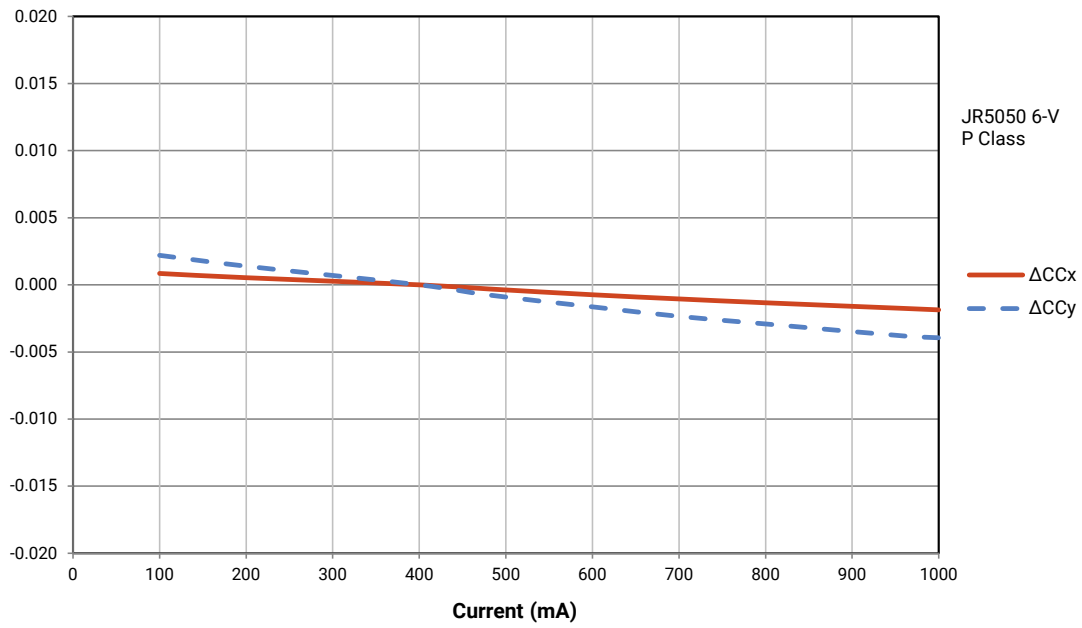

RELATIVE CHROMATICITY VS. TEMPERATURE - JR5050 6-V P CLASS

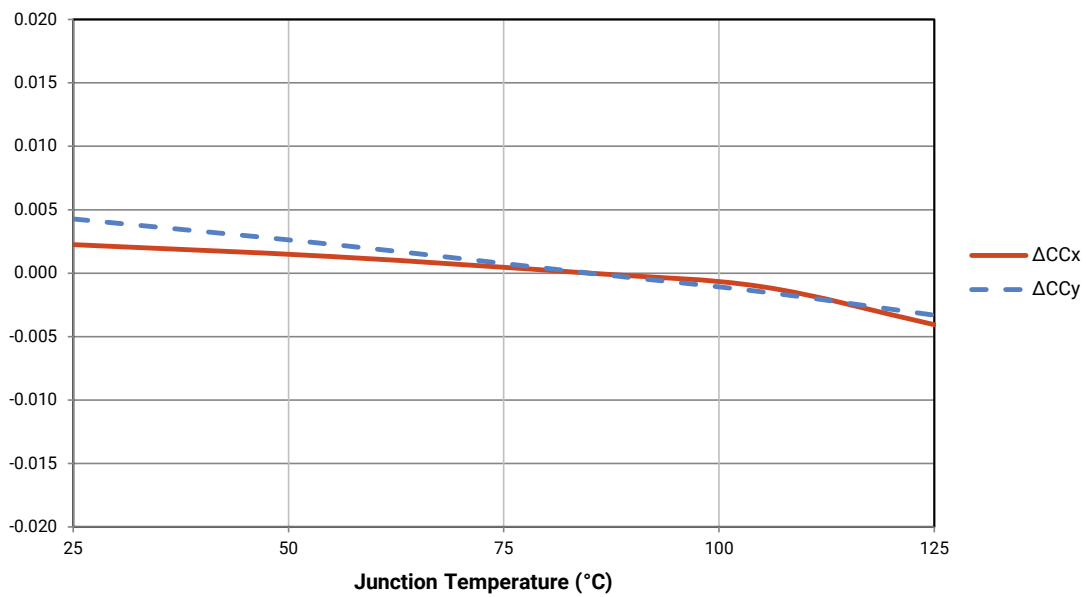

RELATIVE LUMINOUS FLUX VS. JUNCTION TEMPERATURE - JR5050 6-V P CLASS

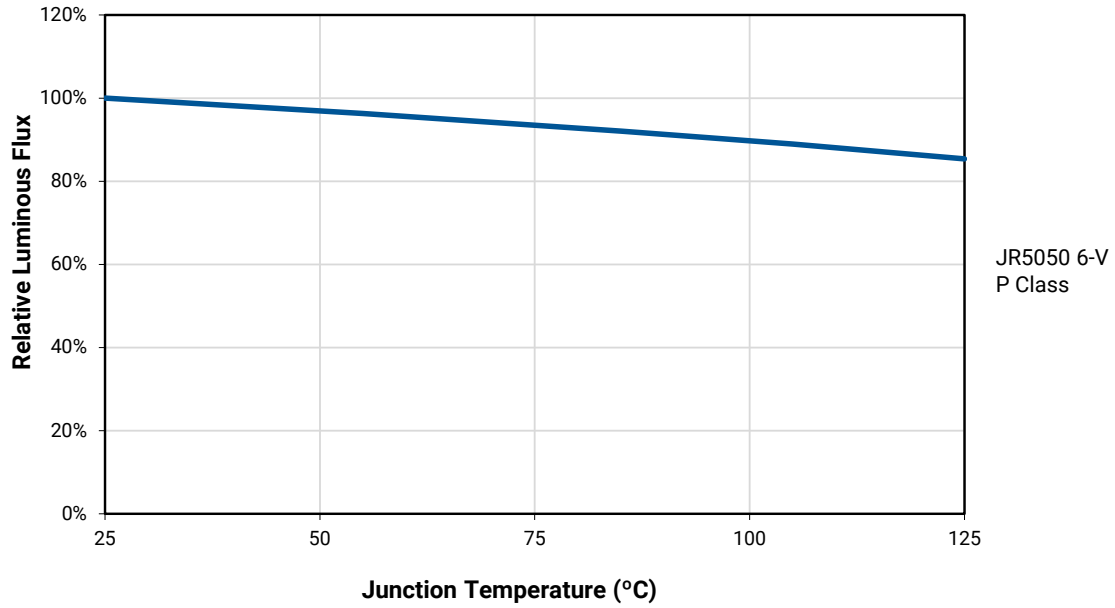

JR5050 9-V P CLASS

CHARACTERISTICS - JR5050 9-V P CLASS

Characteristics	Unit	Minimum	Typical	Maximum
Thermal resistance, junction to solder point ^o	°C/W		1.2	
Viewing angle (FWHM)	degrees		120	
Temperature coefficient of voltage	mV/°C		-3.5	
ESD withstand voltage (HBM per Mil-Std-883L)			Class 2	
DC forward current	mA			660
Reverse voltage	V			5
Forward voltage (@ 260 mA, 25 °C)	V		8.56	9.0
LED junction temperature	°C			125
Operating temperature	°C	-40		105

- Note:
- ◇ Thermal resistance measurement was performed per the JEDEC JESD51-14 standard. See the [Thermal Resistance Measurement application note](#) for more details.
 - Continuous reverse voltage can cause LED damage.

OPERATING LIMITS - JR5050 9-V P CLASS

The maximum forward current is determined by the thermal resistance between the LED junction and ambient.

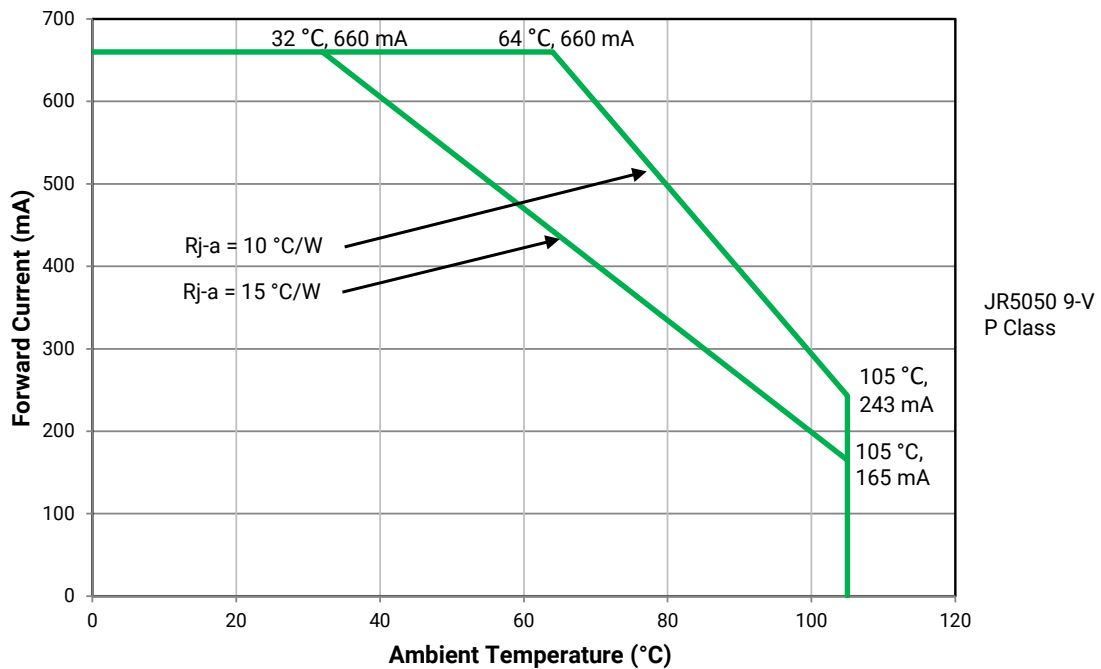

FLUX CHARACTERISTICS, ORDER CODES AND BINS - JR5050 9-V P CLASS ($I_F = 260 \text{ mA}$, $T_j = 25 \text{ °C}$)

The following table provides order codes for J Series 5050 9-V P Class LEDs. For a complete description of the order code nomenclature, please see the Order Code and Bin Code Formats section (page 4). For definitions of the chromaticity kits, please see the Performance Groups - Chromaticity section (page 69).

Nominal CCT	Minimum CRI	Minimum Luminous Flux (lm) @ 25 °C	Typical Luminous Flux (lm) @ 25 °C	Typical Luminous Flux (lm) @ 85 °C*	Kitted 3-Step Order Code**
6500 K	70	350	434	398	JR5050AWT-P-B65EC0000-N0000001
	80	350	403	369	JR5050AWT-P-H65EC0000-N0000001
	90	250	342	314	JR5050AWT-P-U65EC0000-N0000001
5700 K	70	350	434	398	JR5050AWT-P-B57EC0000-N0000001
	80	350	403	369	JR5050AWT-P-H57EC0000-N0000001
	90	300	342	314	JR5050AWT-P-U57EC0000-N0000001
5000 K	70	350	434	398	JR5050AWT-P-B50EC0000-N0000001
	80	350	403	369	JR5050AWT-P-H50EC0000-N0000001
	90	300	342	314	JR5050AWT-P-U50EC0000-N0000001
4000 K	70	350	434	398	JR5050AWT-P-B40EC0000-N0000001
	80	350	403	369	JR5050AWT-P-H40EC0000-N0000001
	90	300	342	314	JR5050AWT-P-U40EC0000-N0000001
3500 K	70	350	421	386	JR5050AWT-P-B35EC0000-N0000001
	80	350	393	360	JR5050AWT-P-H35EC0000-N0000001
	90	250	320	293	JR5050AWT-P-U35EC0000-N0000001
3000 K	70	350	412	378	JR5050AWT-P-B30EC0000-N0000001
	80	300	383	351	JR5050AWT-P-H30EC0000-N0000001
	90	250	315	289	JR5050AWT-P-U30EC0000-N0000001
2700 K	70	350	395	362	JR5050AWT-P-B27EC0000-N0000001
	80	300	366	336	JR5050AWT-P-H27EC0000-N0000001
	90	250	298	273	JR5050AWT-P-U27EC0000-N0000001

Notes:

- Cree Venture maintains a tolerance of $\pm 7\%$ on flux and power measurements, ± 0.005 on chromaticity (CCx, CCy) measurements and ± 2 on CRI measurements. See the Measurements section (page 79).
- Cree Venture J Series 5050 LED order codes specify only a minimum flux bin and not a maximum. Cree Venture may ship reels in flux bins higher than the minimum specified by the order code without advance notice. Shipments will always adhere to the chromaticity restrictions specified by the order code.
- * Flux values @ 85 °C are calculated and for reference only.
- ** Contact your Cree sales representative for kitted 3-step order code details.

FLUX CHARACTERISTICS, ORDER CODES AND BINS - JR5050 9-V P CLASS FOR HORTICULTURE (I_F = 260 mA, T_J = 25 °C)

The following table provides order codes for J Series 5050 9-V P Class LEDs. For a complete description of the order code nomenclature, please see the Order Code and Bin Code Formats section (page 4). For definitions of the chromaticity kits, please see the Performance Groups - Chromaticity section (page 69).

Nominal CCT	Minimum CRI	Minimum Luminous Flux (lm) @ 25 °C	Typical Luminous Flux (lm) @ 25 °C	Typical Luminous Efficacy (lm/W)	PPF* (μmol/s)	PPF/W* (μmol/J)	Kitted 3-Step Order Code**
6500 K	70	350	434	195	6.04	2.71	JR5050AWT-P-B65EC0000-N0000001
	80	350	403	181	5.86	2.63	JR5050AWT-P-H65EC0000-N0000001
	90	250	342	154	5.48	2.46	JR5050AWT-P-U65EC0000-N0000001
5700 K	70	350	434	195	5.85	2.63	JR5050AWT-P-B57EC0000-N0000001
	80	350	403	181	5.73	2.57	JR5050AWT-P-H57EC0000-N0000001
	90	300	342	154	5.33	2.39	JR5050AWT-P-U57EC0000-N0000001
5000 K	70	350	434	195	5.76	2.59	JR5050AWT-P-B50EC0000-N0000001
	80	350	403	181	5.64	2.53	JR5050AWT-P-H50EC0000-N0000001
	90	300	342	154	5.25	2.36	JR5050AWT-P-U50EC0000-N0000001
4000 K	70	350	434	195	5.78	2.60	JR5050AWT-P-B40EC0000-N0000001
	80	350	403	181	5.66	2.54	JR5050AWT-P-H40EC0000-N0000001
	90	300	342	154	5.27	2.37	JR5050AWT-P-U40EC0000-N0000001
3500 K	70	350	421	189	5.69	2.56	JR5050AWT-P-B35EC0000-N0000001
	80	350	393	177	5.60	2.52	JR5050AWT-P-H35EC0000-N0000001
	90	250	320	144	5.00	2.24	JR5050AWT-P-U35EC0000-N0000001
3000 K	70	350	412	185	5.66	2.54	JR5050AWT-P-B30EC0000-N0000001
	80	300	383	172	5.54	2.49	JR5050AWT-P-H30EC0000-N0000001
	90	250	315	142	4.98	2.24	JR5050AWT-P-U30EC0000-N0000001
2700 K	70	350	395	177	5.50	2.47	JR5050AWT-P-B27EC0000-N0000001
	80	300	366	164	5.36	2.41	JR5050AWT-P-H27EC0000-N0000001
	90	250	298	134	4.77	2.14	JR5050AWT-P-U27EC0000-N0000001

Notes:

- Cree Venture maintains a tolerance of ±7% on flux and power measurements, ±0.005 on chromaticity (CCx, CCy) measurements and ±2 on CRI measurements. See the Measurements section (page 79).
- Cree Venture J Series 5050 LED order codes specify only a minimum flux bin and not a maximum. Cree Venture may ship reels in flux bins higher than the minimum specified by the order code without advance notice. Shipments will always adhere to the chromaticity restrictions specified by the order code.
- * PPF values are calculated from luminous flux values and are for reference only.
- ** Contact your Cree LED sales representative for kitted 3-step order code details.

RELATIVE LUMINOUS FLUX VS. CURRENT - JR5050 9-V P CLASS

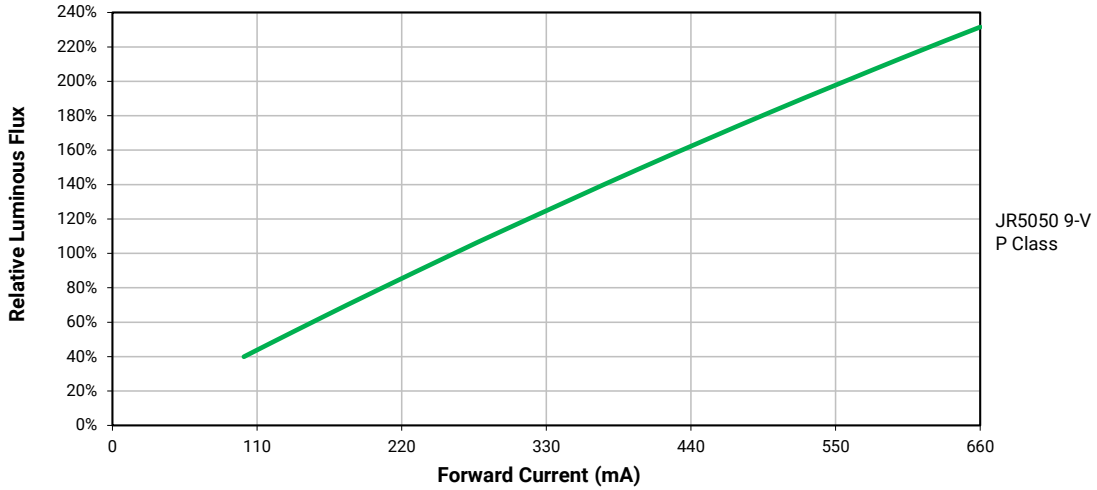

ELECTRICAL CHARACTERISTICS - JR5050 9-V P CLASS

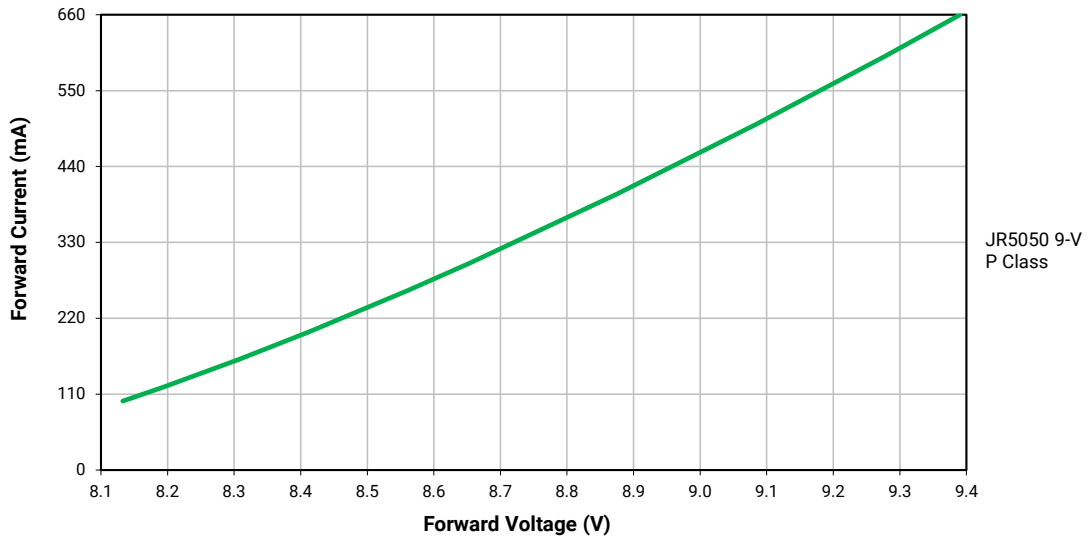

RELATIVE CHROMATICITY VS. CURRENT - JR5050 9-V P CLASS

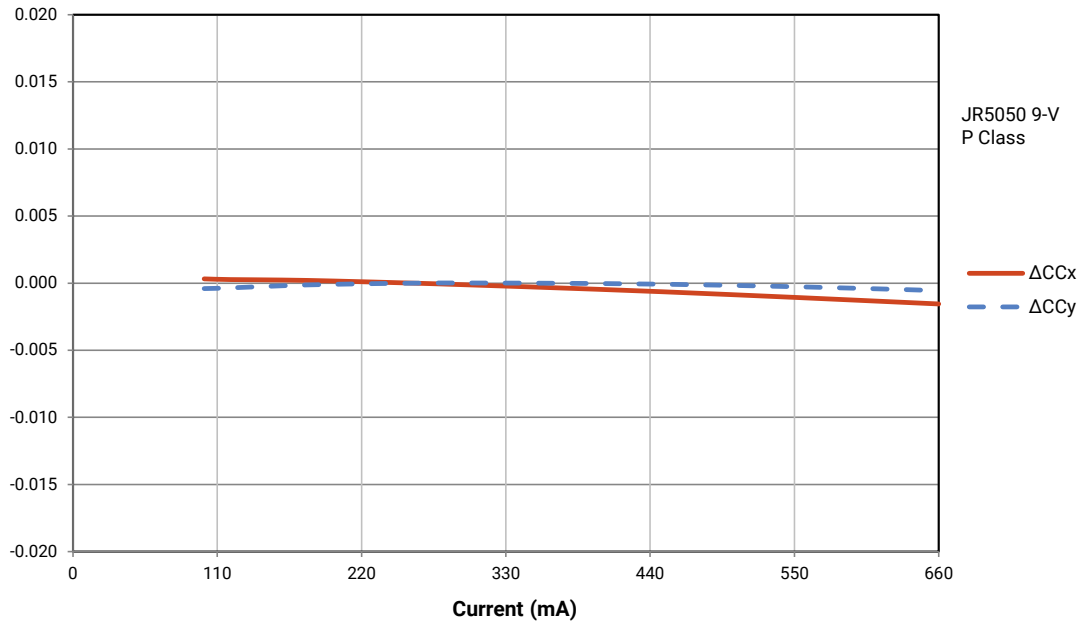

RELATIVE CHROMATICITY VS. TEMPERATURE - JR5050 9-V P CLASS

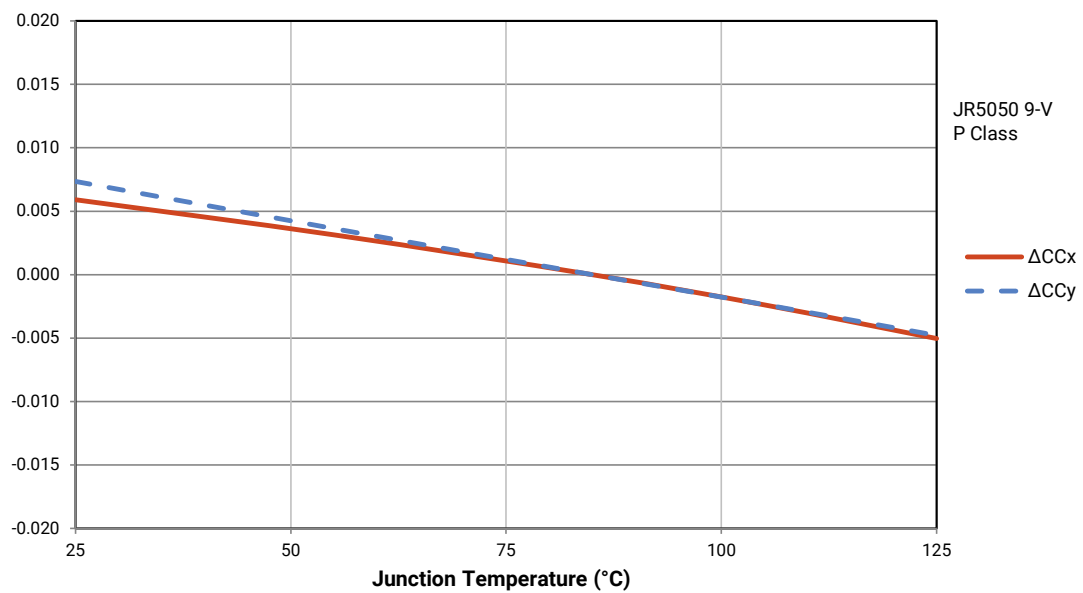

RELATIVE LUMINOUS FLUX VS. JUNCTION TEMPERATURE - JR5050 9-V P CLASS

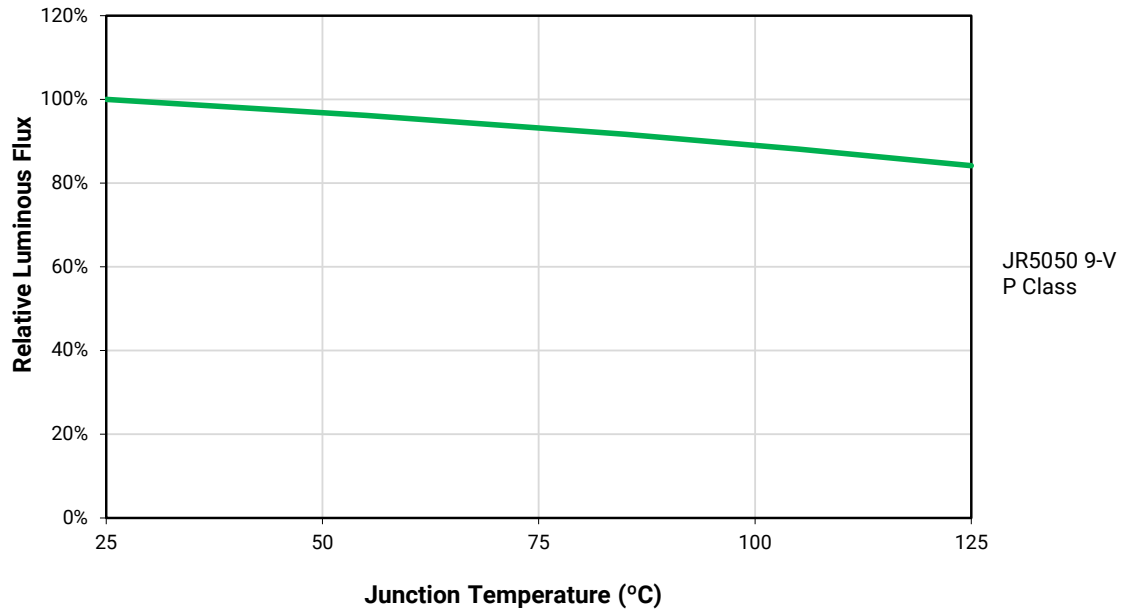

JR5050 24-V P CLASS

CHARACTERISTICS - JR5050 24-V P CLASS

Characteristics	Unit	Minimum	Typical	Maximum
Thermal resistance, junction to solder point ^o	°C/W		1.2	
Viewing angle (FWHM)	degrees		120	
Temperature coefficient of voltage	mV/°C		-8.5	
ESD withstand voltage (HBM per Mil-Std-883L)			Class 2	
DC forward current	mA			240
Reverse voltage	V			5
Forward voltage (@ 100 mA, 25 °C)	V		23.08	24.5
LED junction temperature	°C			125
Operating temperature	°C	-40		105

- Note:
- ◊ Thermal resistance measurement was performed per the JEDEC JESD51-14 standard. See the [Thermal Resistance Measurement application note](#) for more details.
 - Continuous reverse voltage can cause LED damage.

OPERATING LIMITS - JR5050 24-V P CLASS

The maximum forward current is determined by the thermal resistance between the LED junction and ambient.

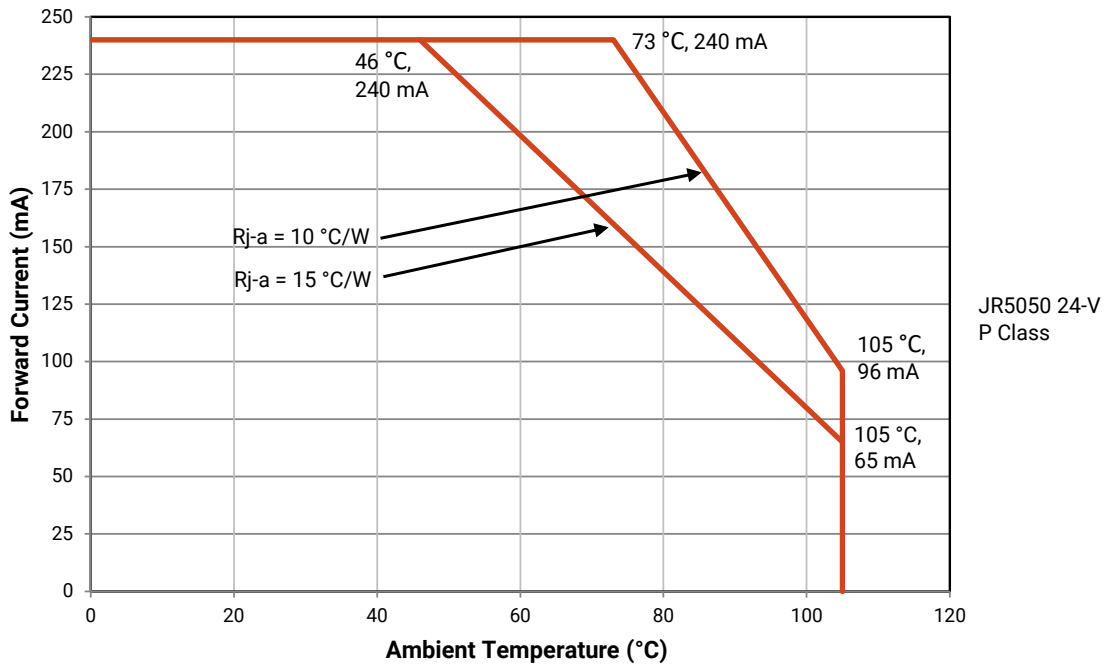

FLUX CHARACTERISTICS, ORDER CODES AND BINS - JR5050 24-V P CLASS ($I_F = 100 \text{ mA}$, $T_j = 25 \text{ }^\circ\text{C}$)

The following table provides order codes for J Series 5050 24-V P Class LEDs. For a complete description of the order code nomenclature, please see the Order Code and Bin Code Formats section (page 4). For definitions of the chromaticity kits, please see the Performance Groups - Chromaticity section (page 69).

Nominal CCT	Minimum CRI	Minimum Luminous Flux (lm) @ 25 °C	Typical Luminous Flux (lm) @ 25 °C	Typical Luminous Flux (lm) @ 85 °C*	Kitted 3-Step Order Code**
6500 K	70	400	442	405	JR5050AWT-P-B65EH0000-N0000001
	80	350	414	380	JR5050AWT-P-H65EH0000-N0000001
	90	300	351	322	JR5050AWT-P-U65EH0000-N0000001
5700 K	70	400	442	405	JR5050AWT-P-B57EH0000-N0000001
	80	350	414	380	JR5050AWT-P-H57EH0000-N0000001
	90	300	351	322	JR5050AWT-P-U57EH0000-N0000001
5000 K	70	400	442	405	JR5050AWT-P-B50EH0000-N0000001
	80	350	414	380	JR5050AWT-P-H50EH0000-N0000001
	90	300	351	322	JR5050AWT-P-U50EH0000-N0000001
4000 K	70	400	442	405	JR5050AWT-P-B40EH0000-N0000001
	80	350	414	380	JR5050AWT-P-H40EH0000-N0000001
	90	300	351	322	JR5050AWT-P-U40EH0000-N0000001
3500 K	70	350	427	392	JR5050AWT-P-B35EH0000-N0000001
	80	350	404	371	JR5050AWT-P-H35EH0000-N0000001
	90	300	341	313	JR5050AWT-P-U35EH0000-N0000001
3000 K	70	350	417	383	JR5050AWT-P-B30EH0000-N0000001
	80	350	394	361	JR5050AWT-P-H30EH0000-N0000001
	90	300	331	304	JR5050AWT-P-U30EH0000-N0000001
2700 K	70	350	402	369	JR5050AWT-P-B27EH0000-N0000001
	80	350	379	348	JR5050AWT-P-H27EH0000-N0000001
	90	250	321	294	JR5050AWT-P-U27EH0000-N0000001

Notes:

- Cree Venture maintains a tolerance of $\pm 7\%$ on flux and power measurements, ± 0.005 on chromaticity (CCx, CCy) measurements and ± 2 on CRI measurements. See the Measurements section (page 79).
- Cree Venture J Series 5050 LED order codes specify only a minimum flux bin and not a maximum. Cree Venture may ship reels in flux bins higher than the minimum specified by the order code without advance notice. Shipments will always adhere to the chromaticity restrictions specified by the order code.
- * Flux values @ 85 °C are calculated and for reference only.
- ** Contact your Cree sales representative for kitted 3-step order code details.

FLUX CHARACTERISTICS, ORDER CODES AND BINS - JR5050 24-V P CLASS FOR HORTICULTURE ($I_f = 100 \text{ mA}$, $T_j = 25 \text{ °C}$)

The following table provides order codes for J Series 5050 24-V P Class LEDs. For a complete description of the order code nomenclature, please see the Order Code and Bin Code Formats section (page 4). For definitions of the chromaticity kits, please see the Performance Groups - Chromaticity section (page 69).

Nominal CCT	Minimum CRI	Minimum Luminous Flux (lm) @ 25 °C	Typical Luminous Flux (lm) @ 25 °C	Typical Luminous Efficacy (lm/W)	PPF* (μmol/s)	PPF/W* (μmol/J)	Kitted 3-Step Order Code**
6500 K	70	400	442	192	6.15	2.67	JR5050AWT-P-B65EH0000-N0000001
	80	350	414	179	6.02	2.61	JR5050AWT-P-H65EH0000-N0000001
	90	300	351	152	5.62	2.43	JR5050AWT-P-U65EH0000-N0000001
5700 K	70	400	442	192	5.96	2.58	JR5050AWT-P-B57EH0000-N0000001
	80	350	414	179	5.88	2.55	JR5050AWT-P-H57EH0000-N0000001
	90	300	351	152	5.47	2.37	JR5050AWT-P-U57EH0000-N0000001
5000 K	70	400	442	192	5.86	2.54	JR5050AWT-P-B50EH0000-N0000001
	80	350	414	179	5.79	2.51	JR5050AWT-P-H50EH0000-N0000001
	90	300	351	152	5.39	2.34	JR5050AWT-P-U50EH0000-N0000001
4000 K	70	400	442	192	5.88	2.55	JR5050AWT-P-B40EH0000-N0000001
	80	350	414	179	5.81	2.52	JR5050AWT-P-H40EH0000-N0000001
	90	300	351	152	5.41	2.34	JR5050AWT-P-U40EH0000-N0000001
3500 K	70	350	427	185	5.77	2.50	JR5050AWT-P-B35EH0000-N0000001
	80	350	404	175	5.75	2.49	JR5050AWT-P-H35EH0000-N0000001
	90	300	341	148	5.32	2.31	JR5050AWT-P-U35EH0000-N0000001
3000 K	70	350	417	181	5.72	2.48	JR5050AWT-P-B30EH0000-N0000001
	80	350	394	171	5.69	2.47	JR5050AWT-P-H30EH0000-N0000001
	90	300	331	143	5.24	2.27	JR5050AWT-P-U30EH0000-N0000001
2700 K	70	350	402	174	5.59	2.42	JR5050AWT-P-B27EH0000-N0000001
	80	350	379	164	5.55	2.40	JR5050AWT-P-H27EH0000-N0000001
	90	250	321	139	5.14	2.23	JR5050AWT-P-U27EH0000-N0000001

Notes:

- Cree Venture maintains a tolerance of ±7% on flux and power measurements, ±0.005 on chromaticity (CCx, CCy) measurements and ±2 on CRI measurements. See the Measurements section (page 79).
- Cree Venture J Series 5050 LED order codes specify only a minimum flux bin and not a maximum. Cree Venture may ship reels in flux bins higher than the minimum specified by the order code without advance notice. Shipments will always adhere to the chromaticity restrictions specified by the order code.
- * PPF values are calculated from luminous flux values and are for reference only.
- ** Contact your Cree LED sales representative for kitted 3-step order code details.

RELATIVE LUMINOUS FLUX VS. CURRENT - JR5050 24-V P CLASS

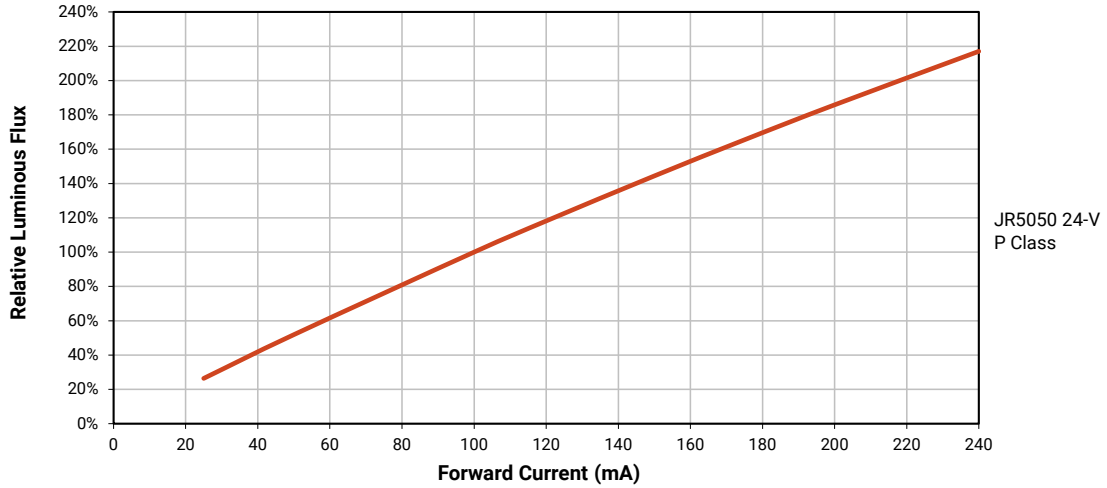

ELECTRICAL CHARACTERISTICS - JR5050 24-V P CLASS

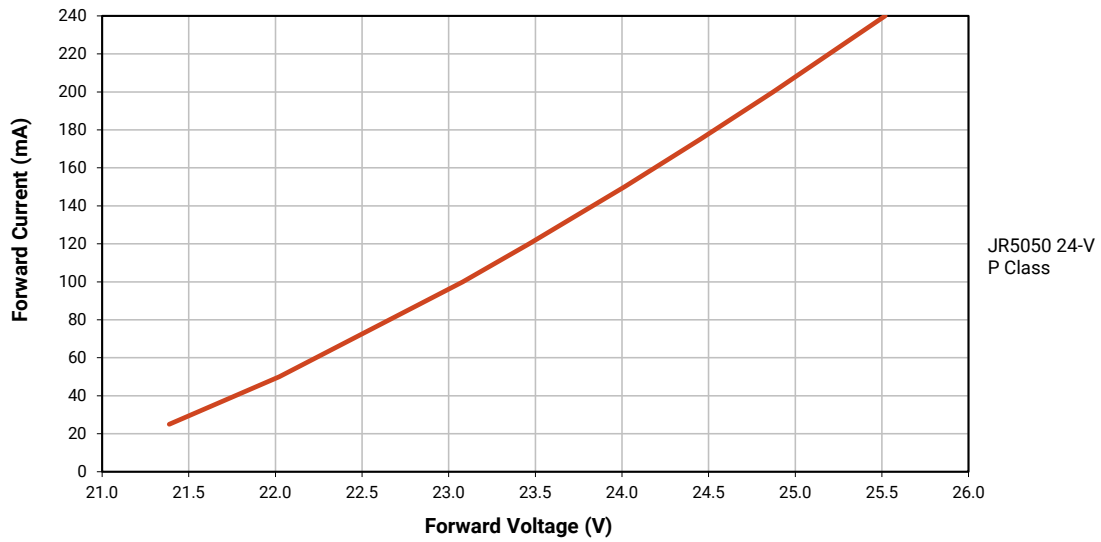

RELATIVE CHROMATICITY VS. CURRENT - JR5050 24-V P CLASS

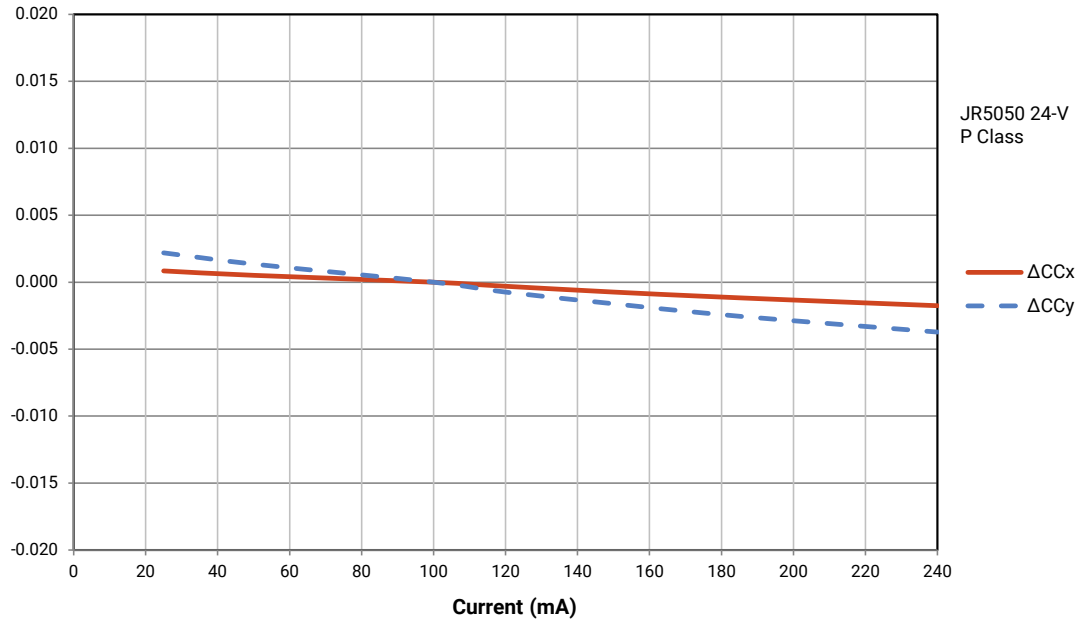

RELATIVE CHROMATICITY VS. TEMPERATURE - JR5050 24-V P CLASS

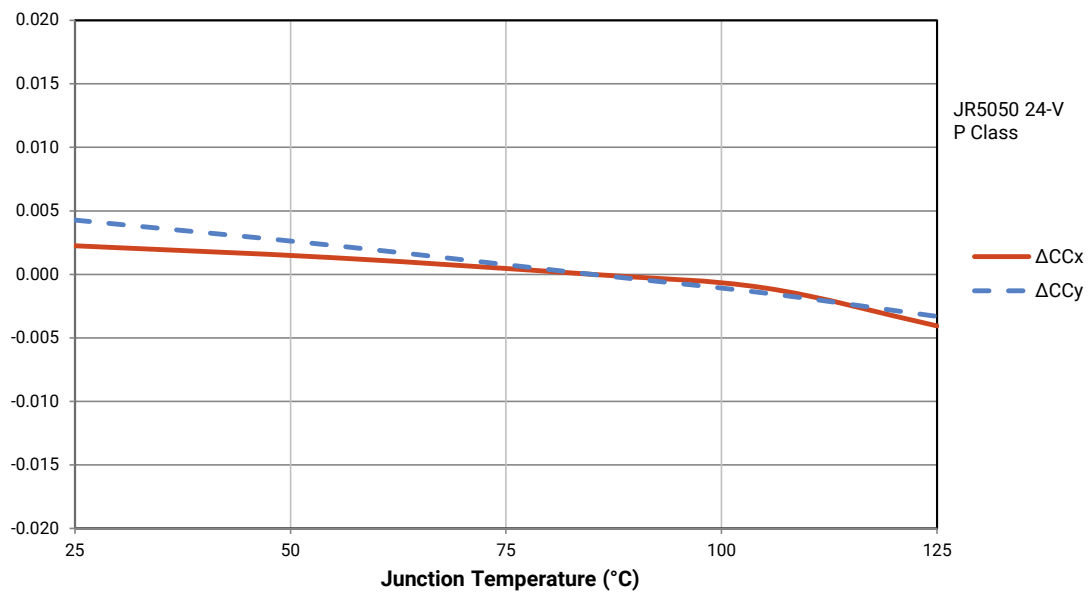

RELATIVE LUMINOUS FLUX VS. JUNCTION TEMPERATURE - JR5050 24-V P CLASS

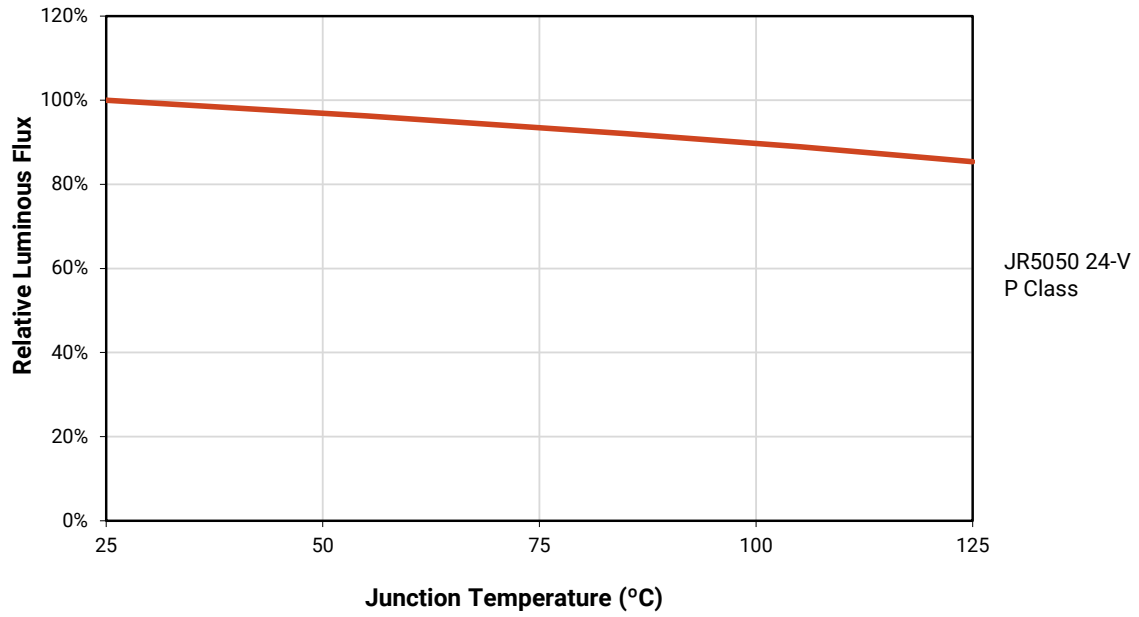

JR5050 6-V Q CLASS

CHARACTERISTICS - JR5050 6-V Q CLASS

Characteristics	Unit	Minimum	Typical	Maximum
Thermal resistance, junction to solder point ^o	°C/W		1.2	
Viewing angle (FWHM)	degrees		120	
Temperature coefficient of voltage	mV/°C		-2	
ESD withstand voltage (HBM per Mil-Std-883L)			Class 2	
DC forward current	mA			1000
Reverse voltage	V			5
Forward voltage (@ 400 mA, 25 °C)	V		5.8	6.0
LED junction temperature	°C			125
Operating temperature	°C	-40		105

- Note:
- ◇ Thermal resistance measurement was performed per the JEDEC JESD51-14 standard. See the [Thermal Resistance Measurement application note](#) for more details.
 - Continuous reverse voltage can cause LED damage.

OPERATING LIMITS - JR5050 6-V Q CLASS

The maximum forward current is determined by the thermal resistance between the LED junction and ambient.

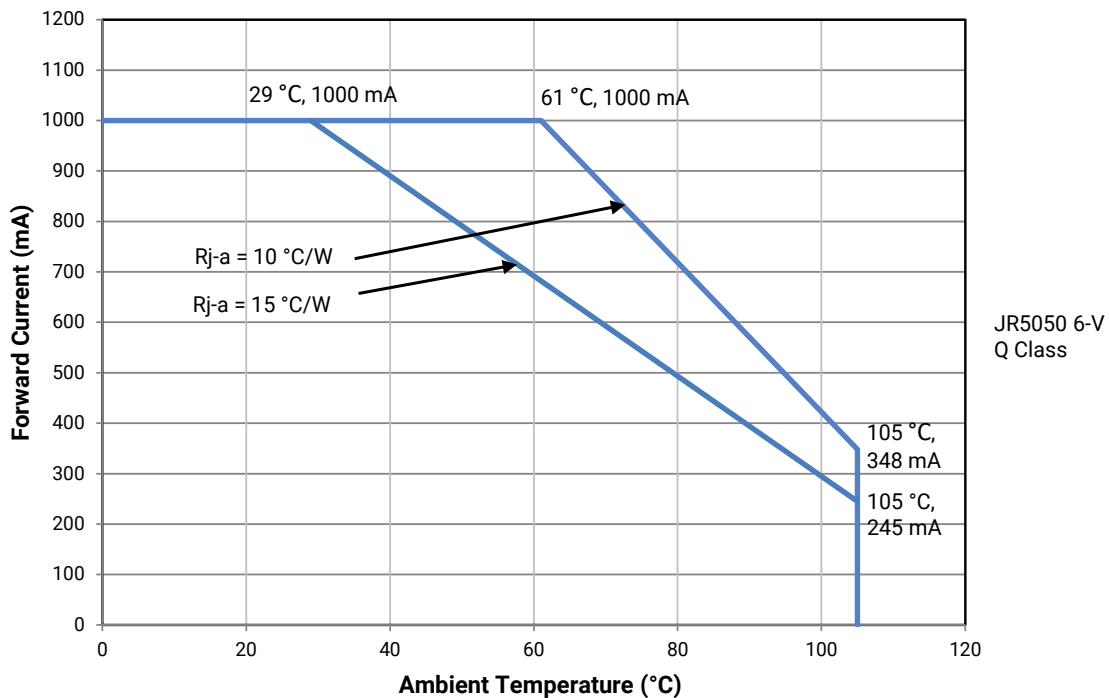

FLUX CHARACTERISTICS, ORDER CODES AND BINS - JR5050 6-V Q CLASS ($I_F = 400 \text{ mA}$, $T_J = 25 \text{ °C}$)

The following table provides order codes for J Series 5050 6-V Q Class LEDs. For a complete description of the order code nomenclature, please see the Order Code and Bin Code Formats section (page 4). For definitions of the chromaticity kits, please see the Performance Groups - Chromaticity section (page 69).

Nominal CCT	Minimum CRI ⁰	Minimum Luminous Flux (lm) @ 25 °C	Typical Luminous Flux (lm) @ 25 °C	Typical Luminous Flux (lm) @ 85 °C*	Kitted 3-Step Order Code**
6500 K	70	350	415	376	JR5050AWT-Q-B65EB0000-N0000001
	80	350	395	358	JR5050AWT-Q-H65EB0000-N0000001
	90	300	335	304	JR5050AWT-Q-U65EB0000-N0000001
5700 K	70	350	425	385	JR5050AWT-Q-B57EB0000-N0000001
	80	350	405	367	JR5050AWT-Q-H57EB0000-N0000001
	90	300	345	313	JR5050AWT-Q-U57EB0000-N0000001
5000 K	70	350	425	385	JR5050AWT-Q-B50EB0000-N0000001
	80	350	405	367	JR5050AWT-Q-H50EB0000-N0000001
	90	300	345	313	JR5050AWT-Q-U50EB0000-N0000001
4000 K	70	350	425	385	JR5050AWT-Q-B40EB0000-N0000001
	80	350	405	367	JR5050AWT-Q-H40EB0000-N0000001
	90	300	345	313	JR5050AWT-Q-U40EB0000-N0000001
3500 K	70	350	410	372	JR5050AWT-Q-B35EB0000-N0000001
	80	350	395	358	JR5050AWT-Q-H35EB0000-N0000001
	90	300	330	299	JR5050AWT-Q-U35EB0000-N0000001
3000 K	70	350	405	367	JR5050AWT-Q-B30EB0000-N0000001
	80	350	385	349	JR5050AWT-Q-H30EB0000-N0000001
	90	250	320	290	JR5050AWT-Q-U30EB0000-N0000001
2700 K	70	350	385	349	JR5050AWT-Q-B27EB0000-N0000001
	80	300	365	331	JR5050AWT-Q-H27EB0000-N0000001
	90	250	305	277	JR5050AWT-Q-U27EB0000-N0000001

Notes:

- Cree Venture maintains a tolerance of $\pm 7\%$ on flux and power measurements, ± 0.005 on chromaticity (CCx, CCy) measurements and ± 2 on CRI measurements. See the Measurements section (page 79).
- Cree Venture J Series 5050 LED order codes specify only a minimum flux bin and not a maximum. Cree Venture may ship reels in flux bins higher than the minimum specified by the order code without advance notice. Shipments will always adhere to the chromaticity restrictions specified by the order code.
- * Flux values @ 85 °C are calculated and for reference only.
- ** Contact your Cree sales representative for kitted 3-step order code details.

RELATIVE LUMINOUS FLUX VS. CURRENT - JR5050 6-V Q CLASS

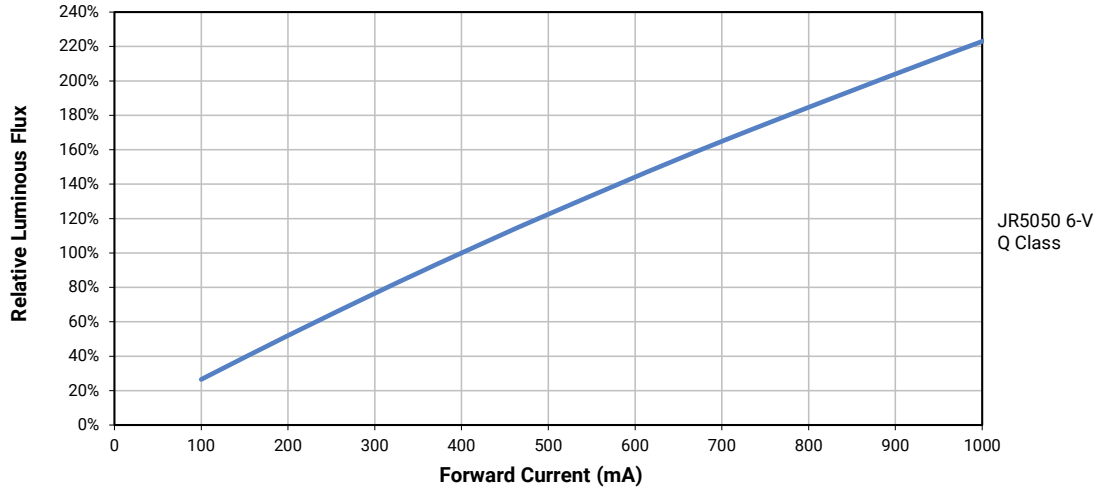

ELECTRICAL CHARACTERISTICS - JR5050 6-V Q CLASS

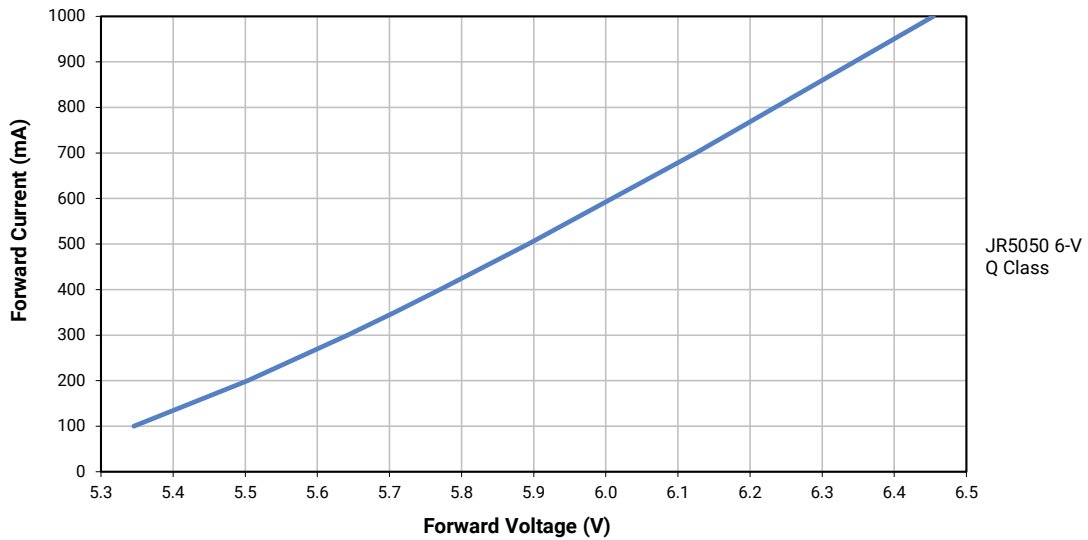

RELATIVE CHROMATICITY VS. CURRENT - JR5050 6-V Q CLASS

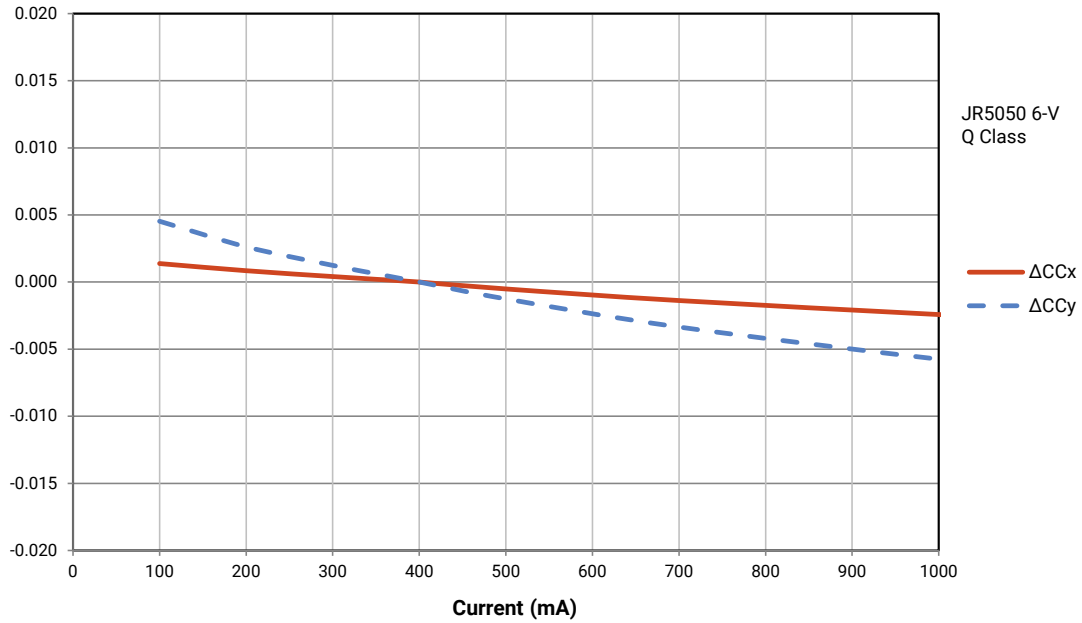

RELATIVE CHROMATICITY VS. TEMPERATURE - JR5050 6-V Q CLASS

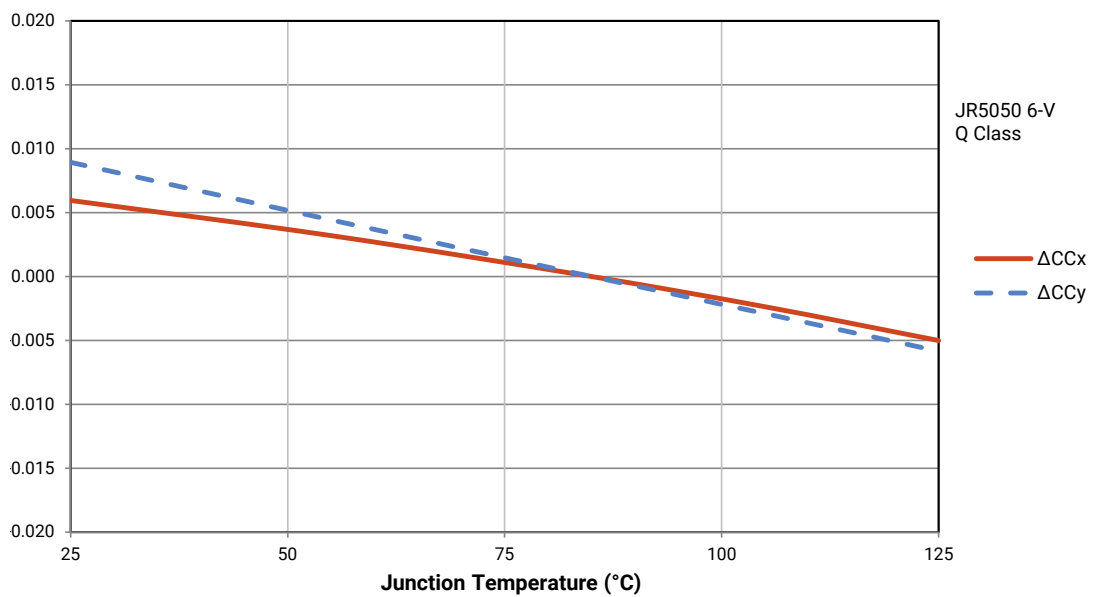

RELATIVE LUMINOUS FLUX VS. JUNCTION TEMPERATURE - JR5050 6-V Q CLASS

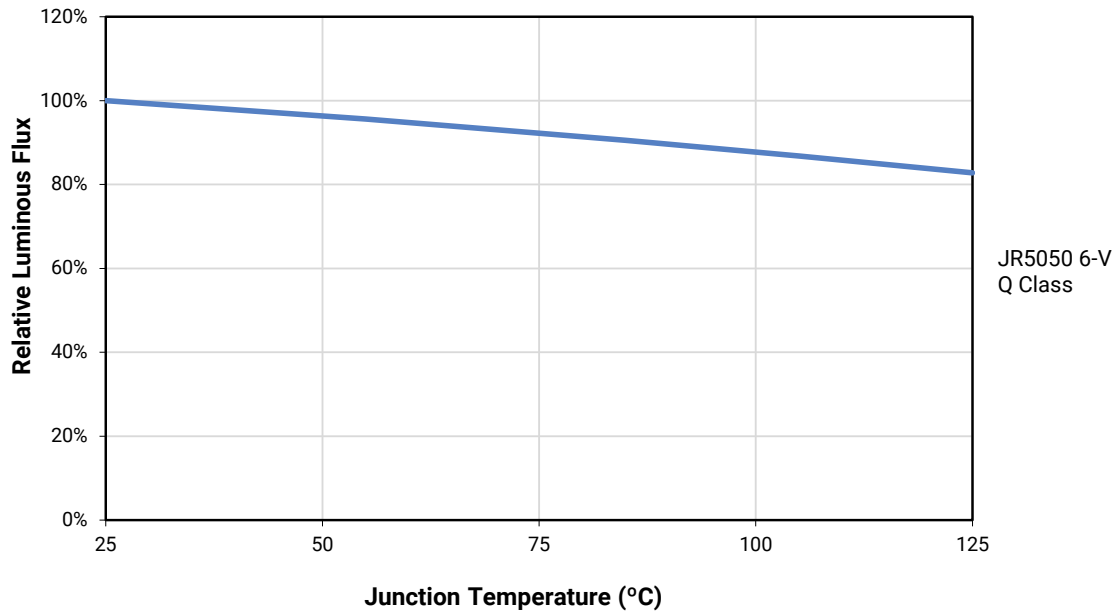

JR5050 9-V Q CLASS

CHARACTERISTICS - JR5050 9-V Q CLASS

Characteristics	Unit	Minimum	Typical	Maximum
Thermal resistance, junction to solder point ^o	°C/W		1.2	
Viewing angle (FWHM)	degrees		120	
Temperature coefficient of voltage	mV/°C		-2.7	
ESD withstand voltage (HBM per Mil-Std-883L)			Class 2	
DC forward current	mA			660
Reverse voltage	V			5
Forward voltage (@ 260 mA, 25 °C)	V		8.6	9.5
LED junction temperature	°C			125
Operating temperature	°C	-40		105

- Note:
- ◇ Thermal resistance measurement was performed per the JEDEC JESD51-14 standard. See the [Thermal Resistance Measurement application note](#) for more details.
 - Continuous reverse voltage can cause LED damage.

OPERATING LIMITS - JR5050 9-V Q CLASS

The maximum forward current is determined by the thermal resistance between the LED junction and ambient.

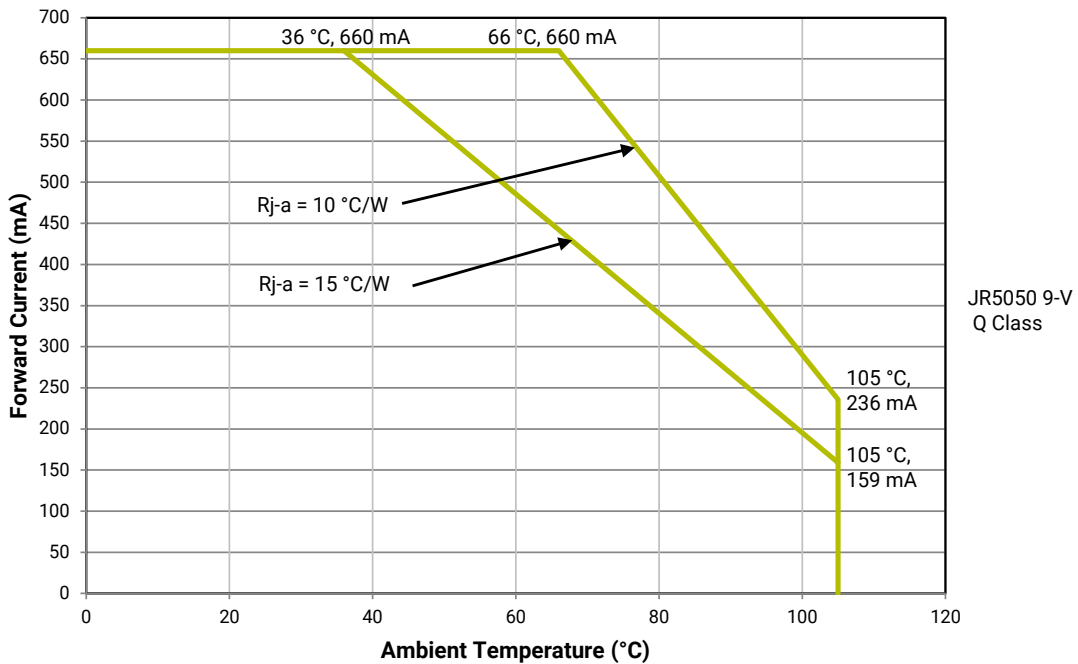

FLUX CHARACTERISTICS, ORDER CODES AND BINS - JR5050 9-V Q CLASS ($I_f = 260 \text{ mA}$, $T_j = 25 \text{ °C}$)

The following table provides order codes for J Series 5050 9-V Q Class LEDs. For a complete description of the order code nomenclature, please see the Order Code and Bin Code Formats section (page 4). For definitions of the chromaticity kits, please see the Performance Groups - Chromaticity section (page 69).

Nominal CCT	Minimum CRI	Minimum Luminous Flux (lm) @ 25 °C	Typical Luminous Flux (lm) @ 25 °C	Typical Luminous Flux (lm) @ 85 °C*	Kitted 3-Step Order Code**
6500 K	70	350	405	368	JR5050AWT-Q-B65EC0000-N0000001
	80	300	380	345	JR5050AWT-Q-H65EC0000-N0000001
	90	250	322	293	JR5050AWT-Q-U65EC0000-N0000001
5700 K	70	350	415	377	JR5050AWT-Q-B57EC0000-N0000001
	80	300	390	355	JR5050AWT-Q-H57EC0000-N0000001
	90	250	332	302	JR5050AWT-Q-U57EC0000-N0000001
5000 K	70	350	415	377	JR5050AWT-Q-B50EC0000-N0000001
	80	300	390	355	JR5050AWT-Q-H50EC0000-N0000001
	90	250	332	302	JR5050AWT-Q-U50EC0000-N0000001
4000 K	70	350	415	377	JR5050AWT-Q-B40EC0000-N0000001
	80	300	390	355	JR5050AWT-Q-H40EC0000-N0000001
	90	250	332	302	JR5050AWT-Q-U40EC0000-N0000001
3500 K	70	350	405	368	JR5050AWT-Q-B35EC0000-N0000001
	80	300	380	345	JR5050AWT-Q-H35EC0000-N0000001
	90	250	322	293	JR5050AWT-Q-U35EC0000-N0000001
3000 K	70	350	395	359	JR5050AWT-Q-B30EC0000-N0000001
	80	300	372	338	JR5050AWT-Q-H30EC0000-N0000001
	90	250	317	288	JR5050AWT-Q-U30EC0000-N0000001
2700 K	70	300	375	341	JR5050AWT-Q-B27EC0000-N0000001
	80	300	355	323	JR5050AWT-Q-H27EC0000-N0000001
	90	250	300	273	JR5050AWT-Q-U27EC0000-N0000001

Notes:

- Cree Venture maintains a tolerance of $\pm 7\%$ on flux and power measurements, ± 0.005 on chromaticity (CCx, CCy) measurements and ± 2 on CRI measurements. See the Measurements section (page 79).
- Cree Venture J Series 5050 LED order codes specify only a minimum flux bin and not a maximum. Cree Venture may ship reels in flux bins higher than the minimum specified by the order code without advance notice. Shipments will always adhere to the chromaticity restrictions specified by the order code.
- * Flux values @ 85 °C are calculated and for reference only.
- ** Contact your Cree sales representative for kitted 3-step order code details.

RELATIVE LUMINOUS FLUX VS. CURRENT - JR5050 9-V Q CLASS

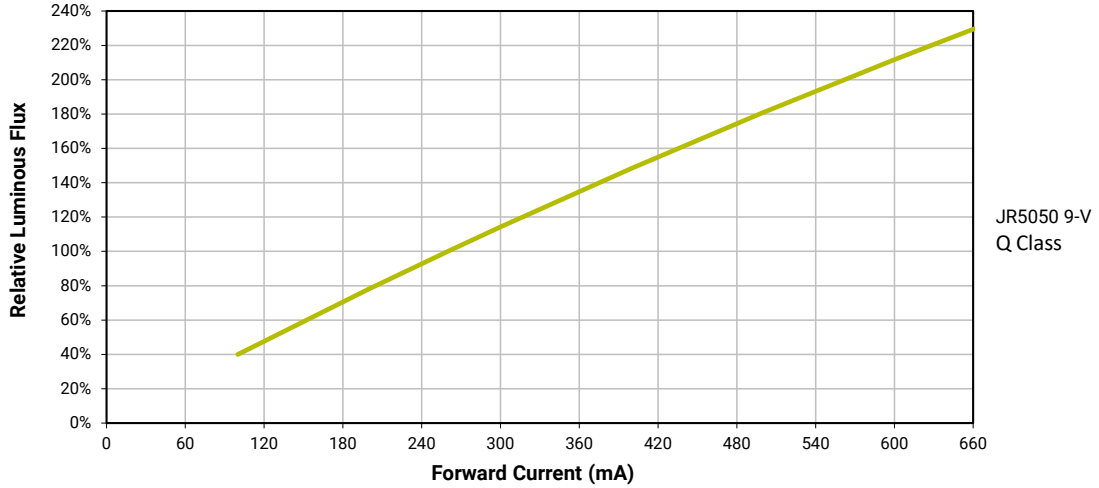

ELECTRICAL CHARACTERISTICS - JR5050 9-V Q CLASS

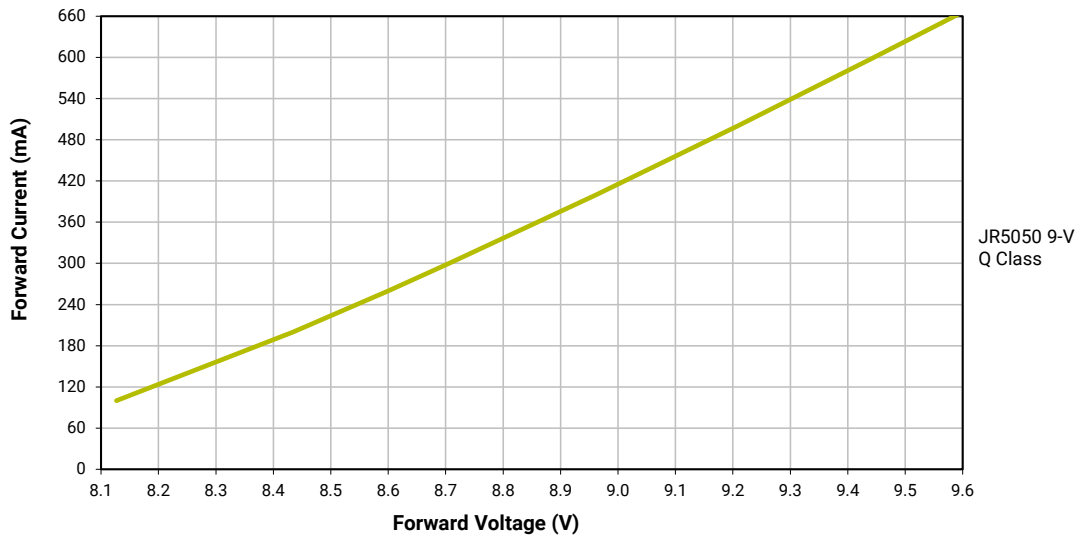

RELATIVE CHROMATICITY VS. CURRENT - JR5050 9-V Q CLASS

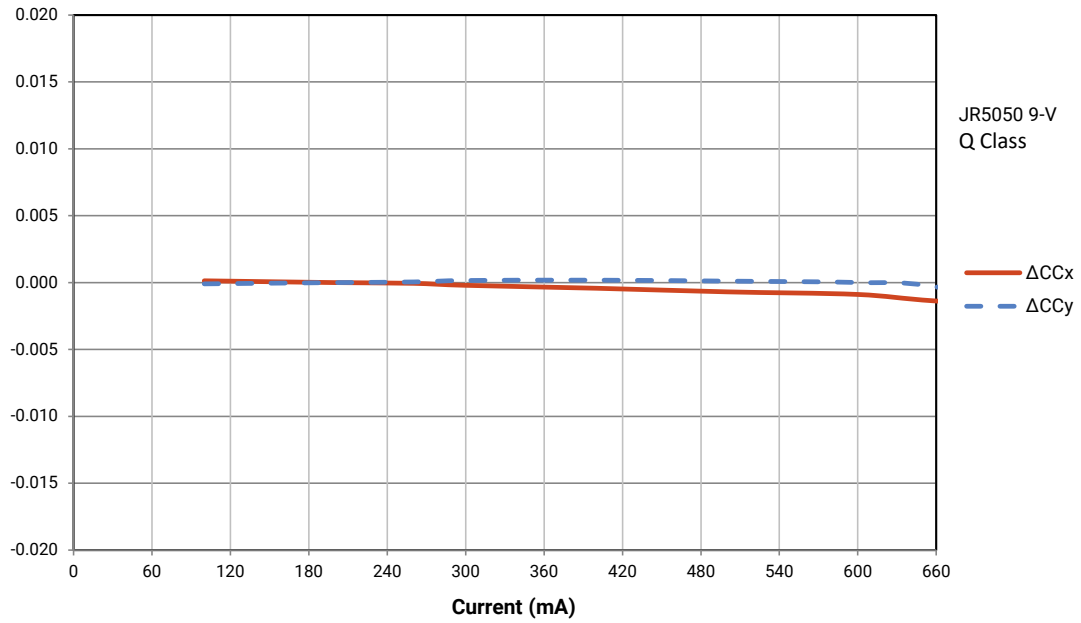

RELATIVE CHROMATICITY VS. TEMPERATURE - JR5050 9-V Q CLASS

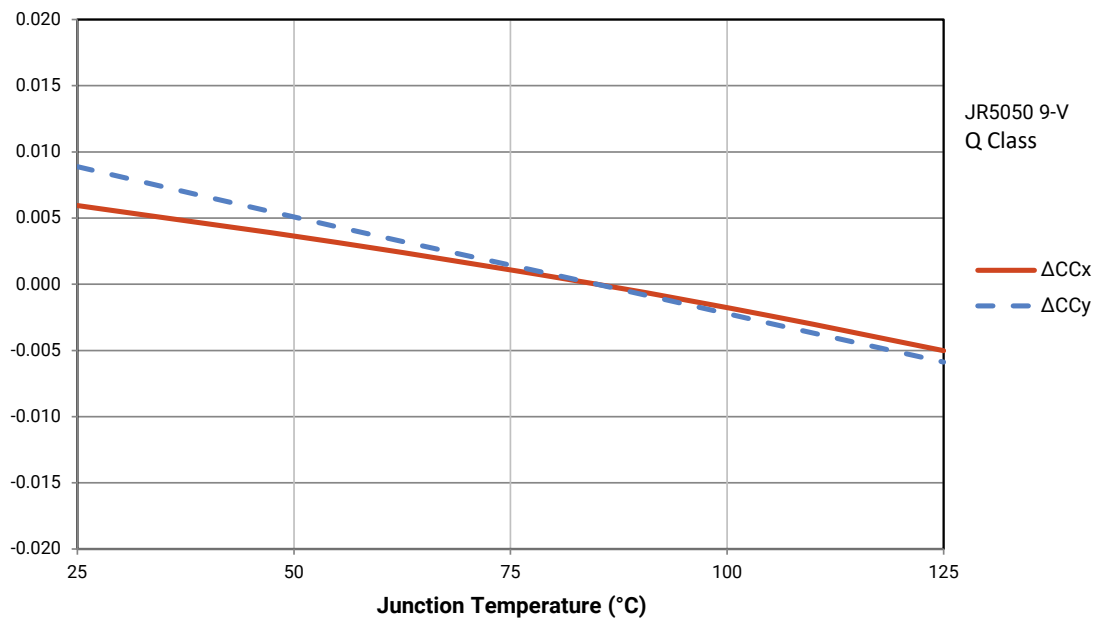

RELATIVE LUMINOUS FLUX VS. JUNCTION TEMPERATURE - JR5050 9-V Q CLASS

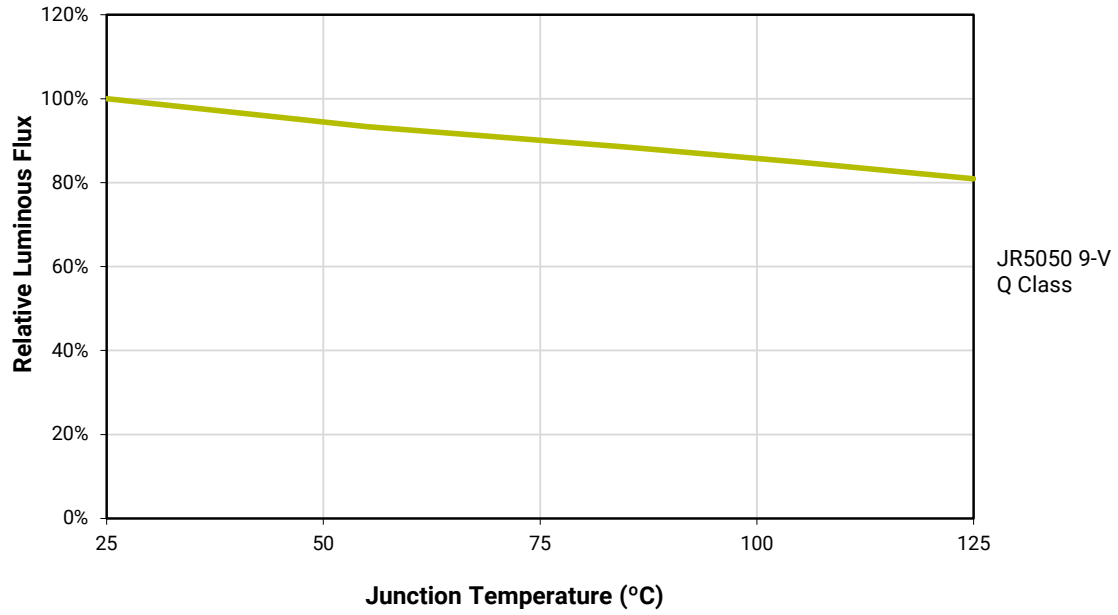

JR5050 24-V Q CLASS

CHARACTERISTICS - JR5050 24-V Q CLASS

Characteristics	Unit	Minimum	Typical	Maximum
Thermal resistance, junction to solder point ^o	°C/W		1.2	
Viewing angle (FWHM)	degrees		120	
Temperature coefficient of voltage	mV/°C		-6.7	
ESD withstand voltage (HBM per Mil-Std-883L)			Class 2	
DC forward current	mA			240
Reverse voltage	V			5
Forward voltage (@ 100 mA, 25 °C)	V		23.5	24.5
LED junction temperature	°C			125
Operating temperature	°C	-40		105

- Note:
- ◇ Thermal resistance measurement was performed per the JEDEC JESD51-14 standard. See the [Thermal Resistance Measurement application note](#) for more details.
 - Continuous reverse voltage can cause LED damage.

OPERATING LIMITS - JR5050 24-V Q CLASS

The maximum forward current is determined by the thermal resistance between the LED junction and ambient.

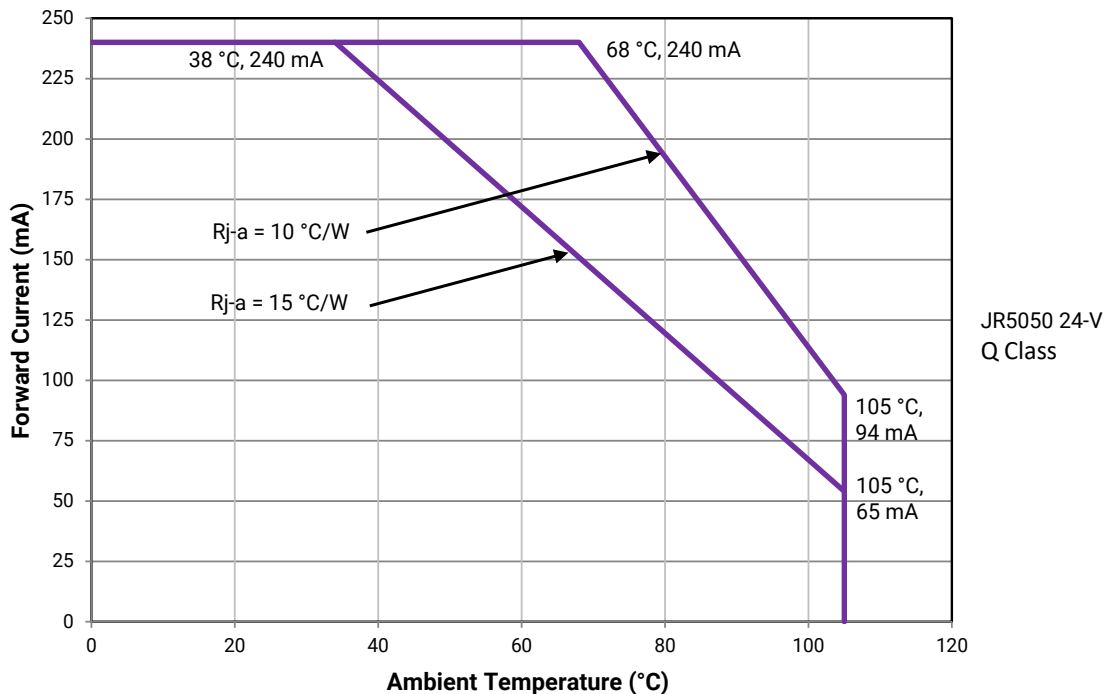

FLUX CHARACTERISTICS, ORDER CODES AND BINS - JR5050 24-V Q CLASS ($I_F = 100 \text{ mA}$, $T_J = 25 \text{ °C}$)

The following table provides order codes for J Series 5050 24-V Q Class LEDs. For a complete description of the order code nomenclature, please see the Order Code and Bin Code Formats section (page 4). For definitions of the chromaticity kits, please see the Performance Groups - Chromaticity section (page 69).

Nominal CCT	Minimum CRI	Minimum Luminous Flux (lm) @ 25 °C	Typical Luminous Flux (lm) @ 25 °C	Typical Luminous Flux (lm) @ 85 °C*	Kitted 3-Step Order Code**
6500 K	70	350	430	392	JR5050AWT-Q-B65EH0000-N0000001
	80	350	405	369	JR5050AWT-Q-H65EH0000-N0000001
	90	300	345	315	JR5050AWT-Q-U65EH0000-N0000001
5700 K	70	350	430	392	JR5050AWT-Q-B57EH0000-N0000001
	80	350	405	369	JR5050AWT-Q-H57EH0000-N0000001
	90	300	345	315	JR5050AWT-Q-U57EH0000-N0000001
5000 K	70	350	430	392	JR5050AWT-Q-B50EH0000-N0000001
	80	350	405	369	JR5050AWT-Q-H50EH0000-N0000001
	90	300	345	315	JR5050AWT-Q-U50EH0000-N0000001
4000 K	70	350	430	392	JR5050AWT-Q-B40EH0000-N0000001
	80	350	405	369	JR5050AWT-Q-H40EH0000-N0000001
	90	300	345	315	JR5050AWT-Q-U40EH0000-N0000001
3500 K	70	350	420	383	JR5050AWT-Q-B35EH0000-N0000001
	80	350	395	360	JR5050AWT-Q-H35EH0000-N0000001
	90	300	335	305	JR5050AWT-Q-U35EH0000-N0000001
3000 K	70	350	410	374	JR5050AWT-Q-B30EH0000-N0000001
	80	300	385	351	JR5050AWT-Q-H30EH0000-N0000001
	90	250	325	296	JR5050AWT-Q-U30EH0000-N0000001
2700 K	70	350	395	360	JR5050AWT-Q-B27EH0000-N0000001
	80	300	370	337	JR5050AWT-Q-H27EH0000-N0000001
	90	250	315	287	JR5050AWT-Q-U27EH0000-N0000001

Notes:

- Cree Venture maintains a tolerance of $\pm 7\%$ on flux and power measurements, ± 0.005 on chromaticity (CCx, CCy) measurements and ± 2 on CRI measurements. See the Measurements section (page 79).
- Cree Venture J Series 5050 LED order codes specify only a minimum flux bin and not a maximum. Cree Venture may ship reels in flux bins higher than the minimum specified by the order code without advance notice. Shipments will always adhere to the chromaticity restrictions specified by the order code.
- * Flux values @ 85 °C are calculated and for reference only.
- ** Contact your Cree sales representative for kitted 3-step order code details.

RELATIVE LUMINOUS FLUX VS. CURRENT - JR5050 24-V Q CLASS

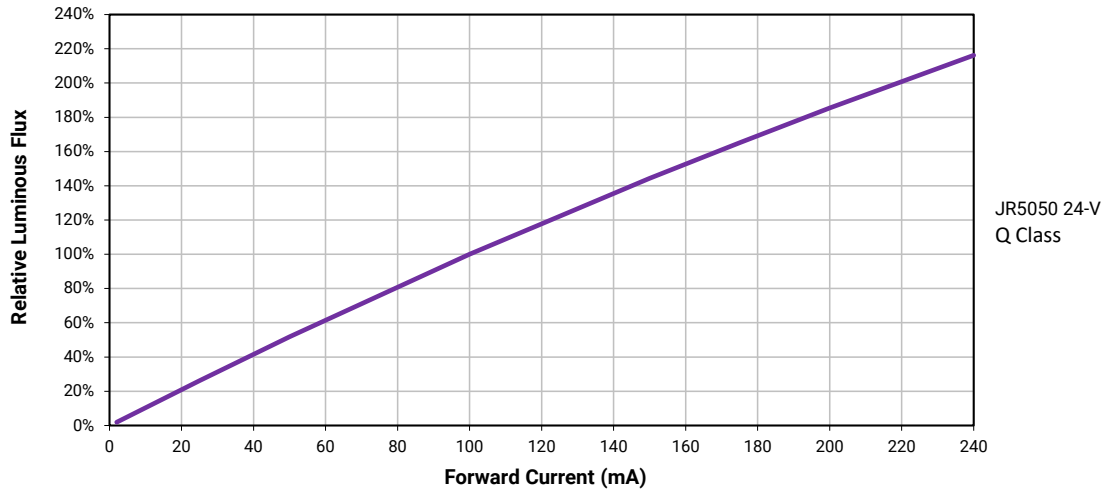

ELECTRICAL CHARACTERISTICS - JR5050 24-V Q CLASS

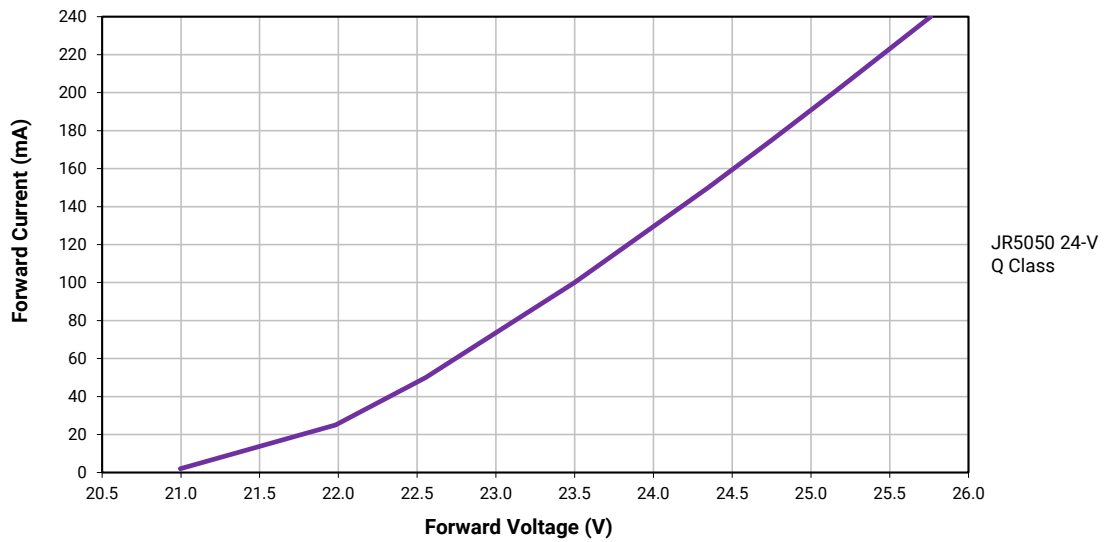

RELATIVE CHROMATICITY VS. CURRENT - JR5050 24-V Q CLASS

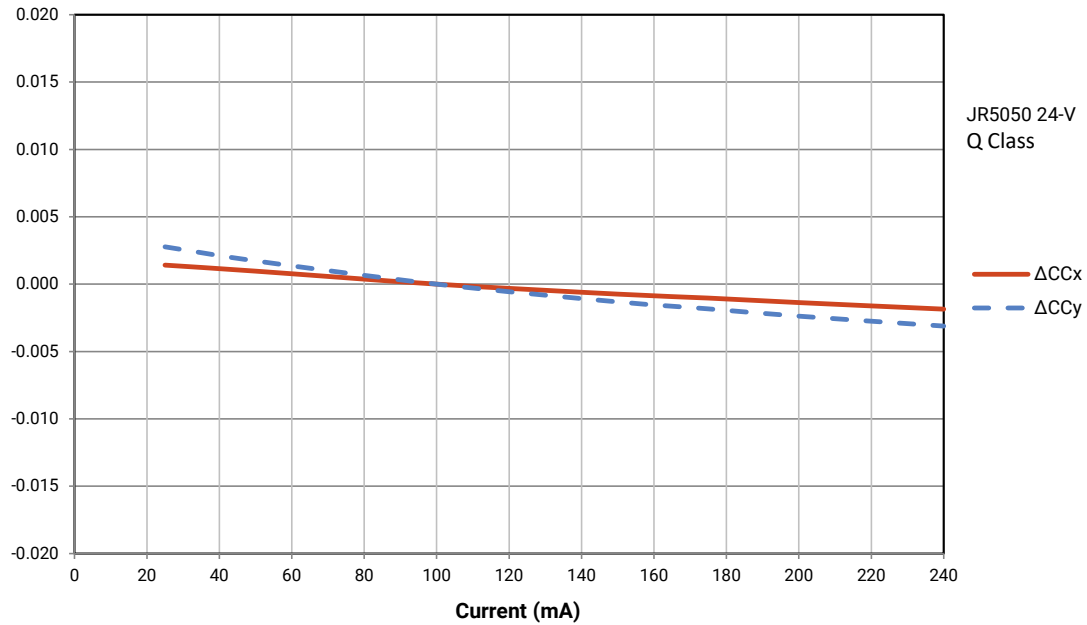

RELATIVE CHROMATICITY VS. TEMPERATURE - JR5050 24-V Q CLASS

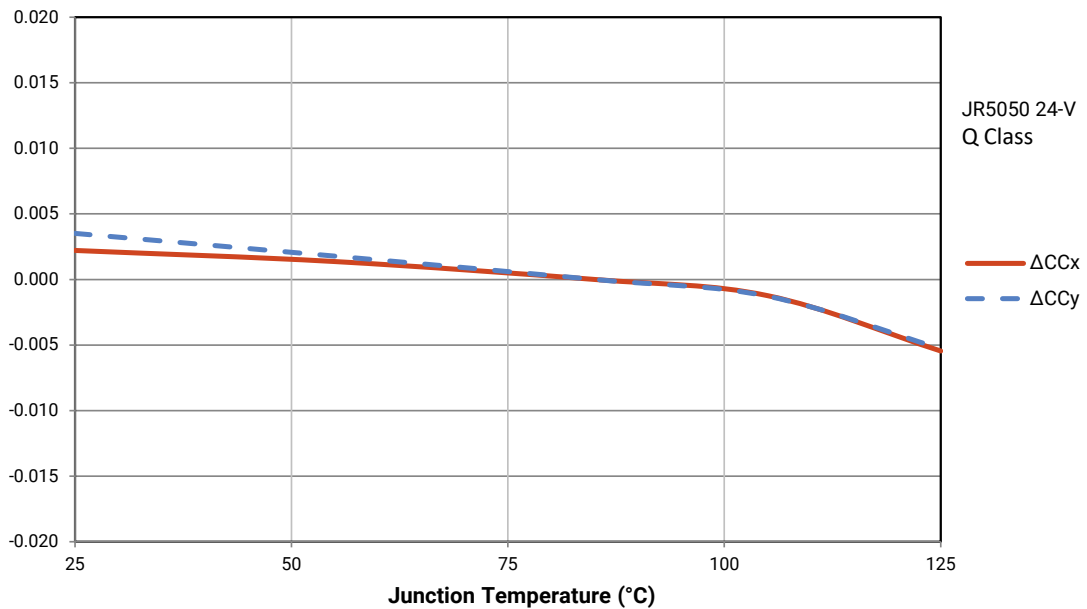

RELATIVE LUMINOUS FLUX VS. JUNCTION TEMPERATURE - JR5050 24-V Q CLASS

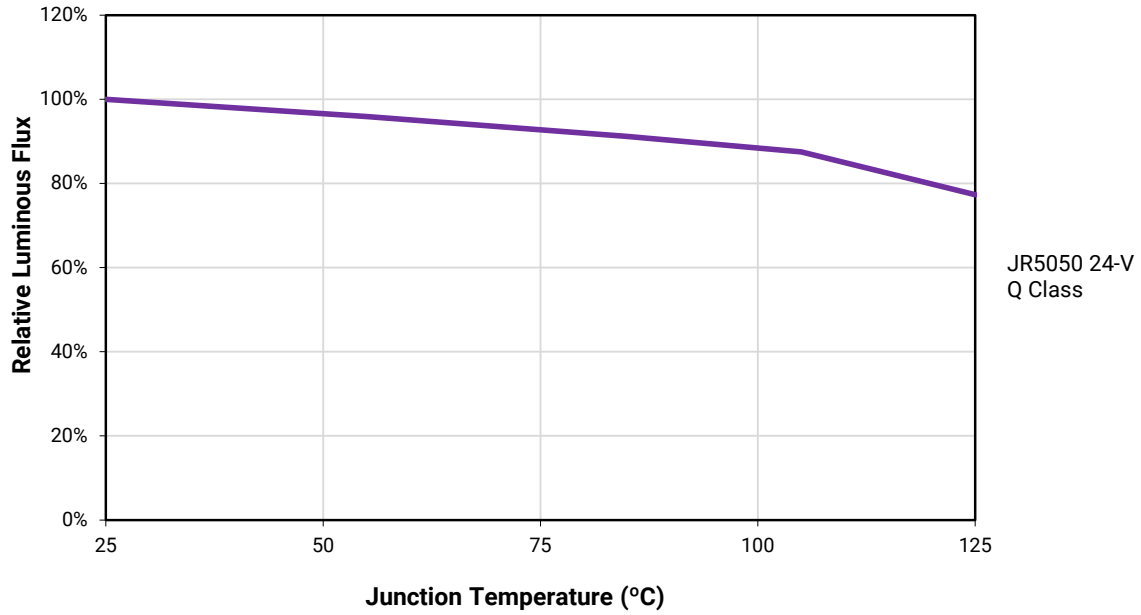

JR5050 36-V Q CLASS

CHARACTERISTICS - JR5050 36-V Q CLASS

Characteristics	Unit	Minimum	Typical	Maximum
Thermal resistance, junction to solder point ^o	°C/W		1.2	
Viewing angle (FWHM)	degrees		120	
Temperature coefficient of voltage	mV/°C		-10	
ESD withstand voltage (HBM per Mil-Std-883L)			Class 2	
DC forward current	mA			165
Reverse voltage	V			5
Forward voltage (@ 65 mA, 25 °C)	V		34.5	36.0
LED junction temperature	°C			125
Operating temperature	°C	-40		105

- Note:
- ◇ Thermal resistance measurement was performed per the JEDEC JESD51-14 standard. See the [Thermal Resistance Measurement application note](#) for more details.
 - Continuous reverse voltage can cause LED damage.

OPERATING LIMITS - JR5050 36-V Q CLASS

The maximum forward current is determined by the thermal resistance between the LED junction and ambient.

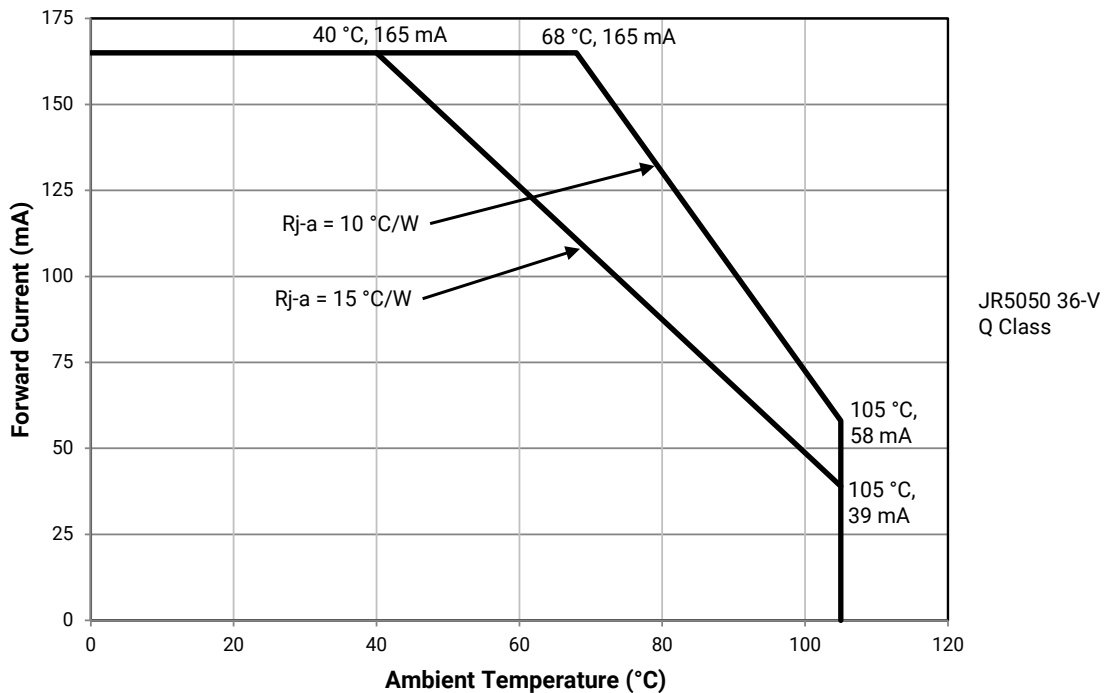

FLUX CHARACTERISTICS, ORDER CODES AND BINS - JR5050 36-V Q CLASS ($I_F = 65 \text{ mA}$, $T_J = 25 \text{ °C}$)

The following table provides order codes for J Series 5050 36-V Q Class LEDs. For a complete description of the order code nomenclature, please see the Order Code and Bin Code Formats section (page 4). For definitions of the chromaticity kits, please see the Performance Groups - Chromaticity section (page 69).

Nominal CCT	Minimum CRI ⁰	Minimum Luminous Flux (lm) @ 25 °C	Typical Luminous Flux (lm) @ 25 °C	Typical Luminous Flux (lm) @ 85 °C*	Kitted 3-Step Order Code**
6500 K	70	350	405	368	JR5050AWT-Q-B65EN0000-N0000001
	80	300	380	345	JR5050AWT-Q-H65EN0000-N0000001
	90	250	322	293	JR5050AWT-Q-U65EN0000-N0000001
5700 K	70	350	415	377	JR5050AWT-Q-B57EN0000-N0000001
	80	300	390	355	JR5050AWT-Q-H57EN0000-N0000001
	90	250	332	302	JR5050AWT-Q-U57EN0000-N0000001
5000 K	70	350	415	377	JR5050AWT-Q-B50EN0000-N0000001
	80	300	390	355	JR5050AWT-Q-H50EN0000-N0000001
	90	250	332	302	JR5050AWT-Q-U50EN0000-N0000001
4000 K	70	350	415	377	JR5050AWT-Q-B40EN0000-N0000001
	80	300	390	355	JR5050AWT-Q-H40EN0000-N0000001
	90	250	332	302	JR5050AWT-Q-U40EN0000-N0000001
3500 K	70	350	405	368	JR5050AWT-Q-B35EN0000-N0000001
	80	300	380	345	JR5050AWT-Q-H35EN0000-N0000001
	90	250	322	293	JR5050AWT-Q-U35EN0000-N0000001
3000 K	70	350	395	359	JR5050AWT-Q-B30EN0000-N0000001
	80	300	372	338	JR5050AWT-Q-H30EN0000-N0000001
	90	250	317	288	JR5050AWT-Q-U30EN0000-N0000001
2700 K	70	300	375	341	JR5050AWT-Q-B27EN0000-N0000001
	80	300	355	323	JR5050AWT-Q-H27EN0000-N0000001
	90	250	300	273	JR5050AWT-Q-U27EN0000-N0000001

Notes:

- Cree Venture maintains a tolerance of $\pm 7\%$ on flux and power measurements, ± 0.005 on chromaticity (CCx, CCy) measurements and ± 2 on CRI measurements. See the Measurements section (page 79).
- Cree Venture J Series 5050 LED order codes specify only a minimum flux bin and not a maximum. Cree Venture may ship reels in flux bins higher than the minimum specified by the order code without advance notice. Shipments will always adhere to the chromaticity restrictions specified by the order code.
- * Flux values @ 85 °C are calculated and for reference only.
- ** Contact your Cree sales representative for kitted 3-step order code details.

RELATIVE LUMINOUS FLUX VS. CURRENT - JR5050 36-V Q CLASS

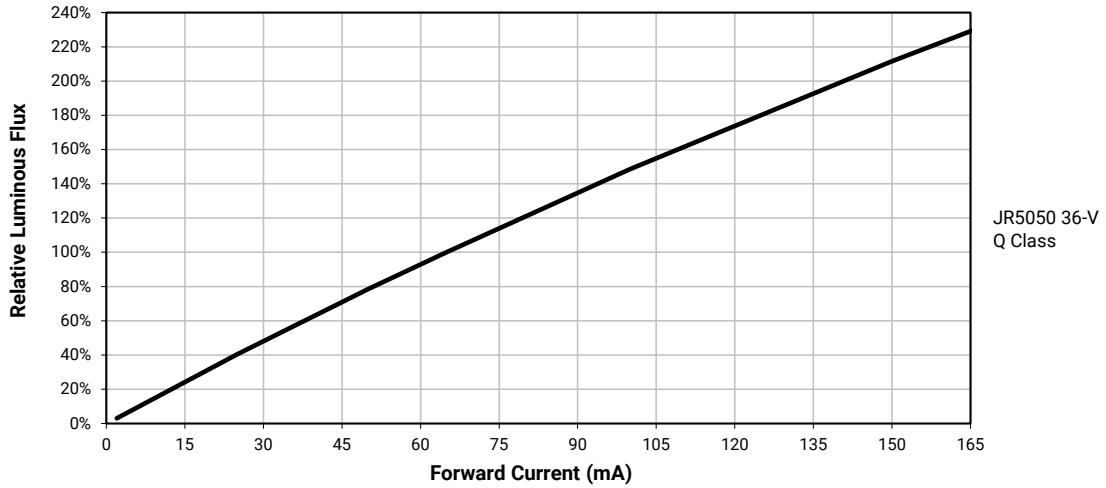

ELECTRICAL CHARACTERISTICS - JR5050 36-V Q CLASS

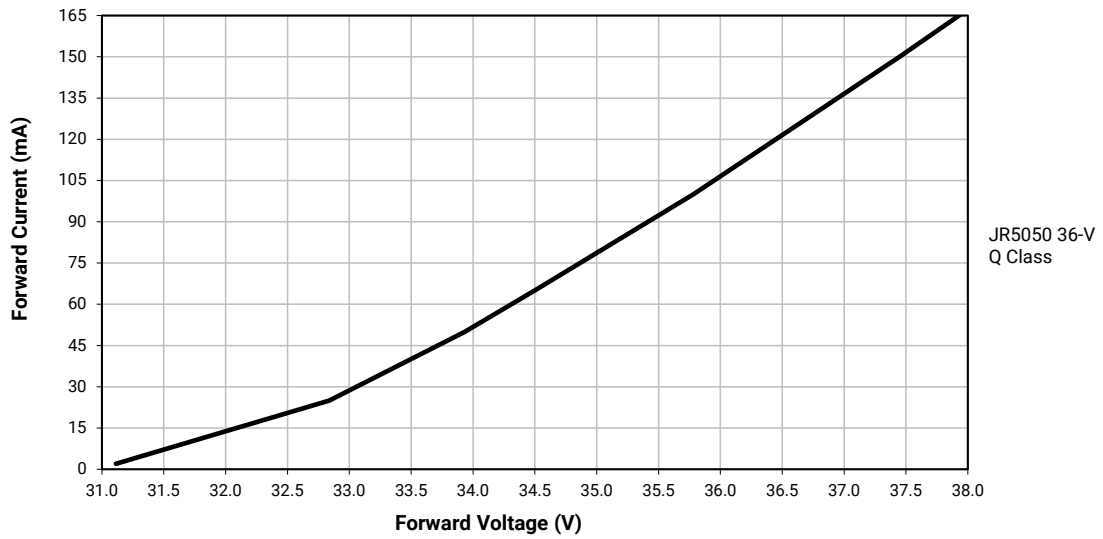

RELATIVE CHROMATICITY VS. CURRENT - JR5050 36-V Q CLASS

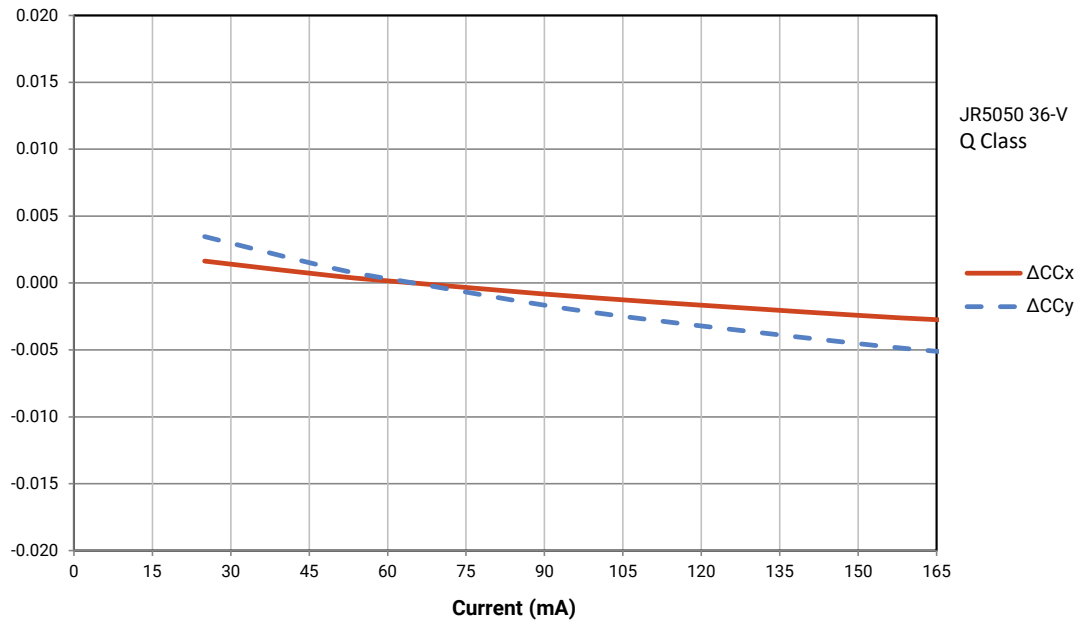

RELATIVE CHROMATICITY VS. TEMPERATURE - JR5050 36-V Q CLASS

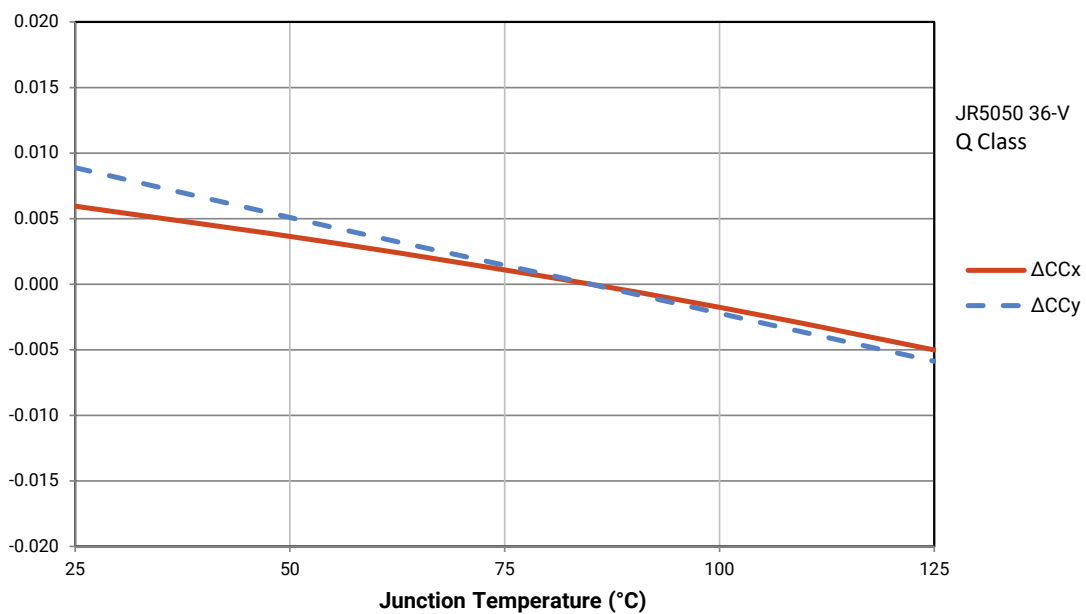

RELATIVE LUMINOUS FLUX VS. JUNCTION TEMPERATURE - JR5050 36-V Q CLASS

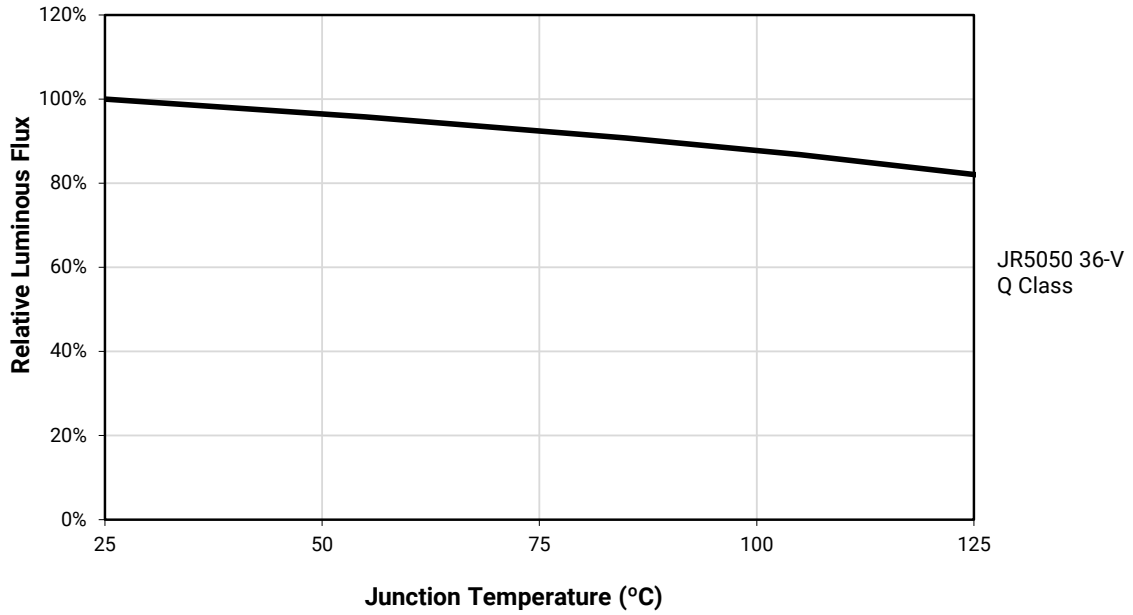

RELATIVE SPECTRAL POWER DISTRIBUTION

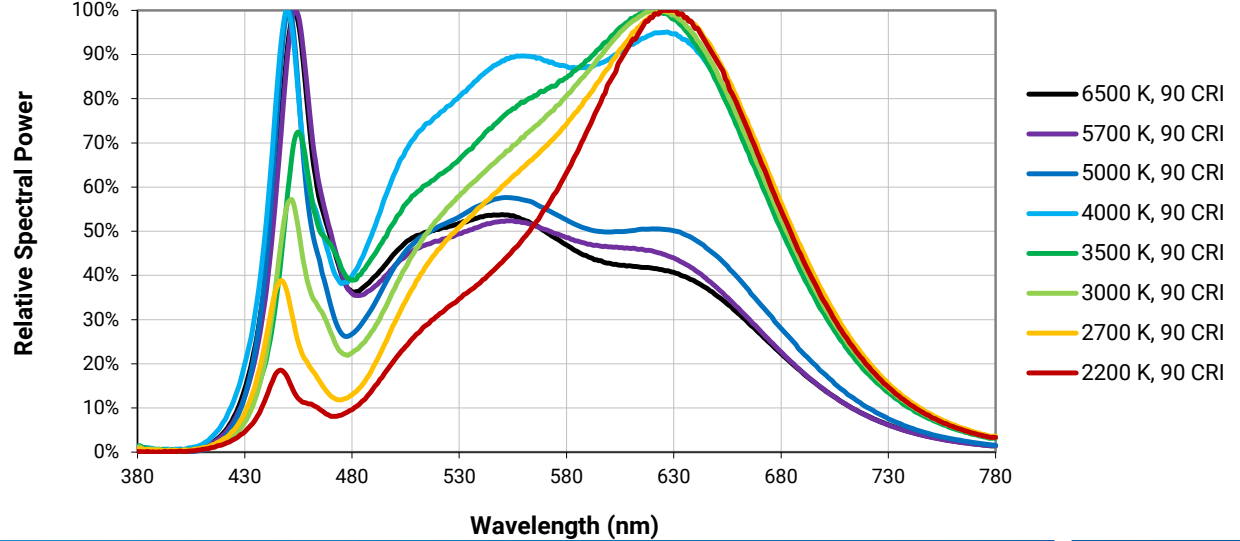
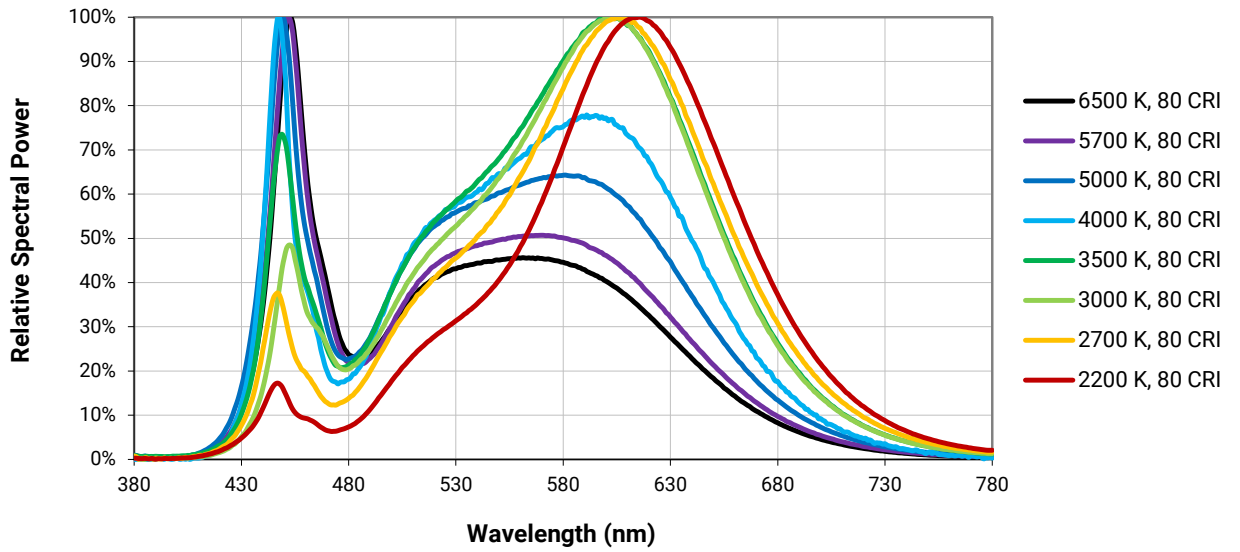
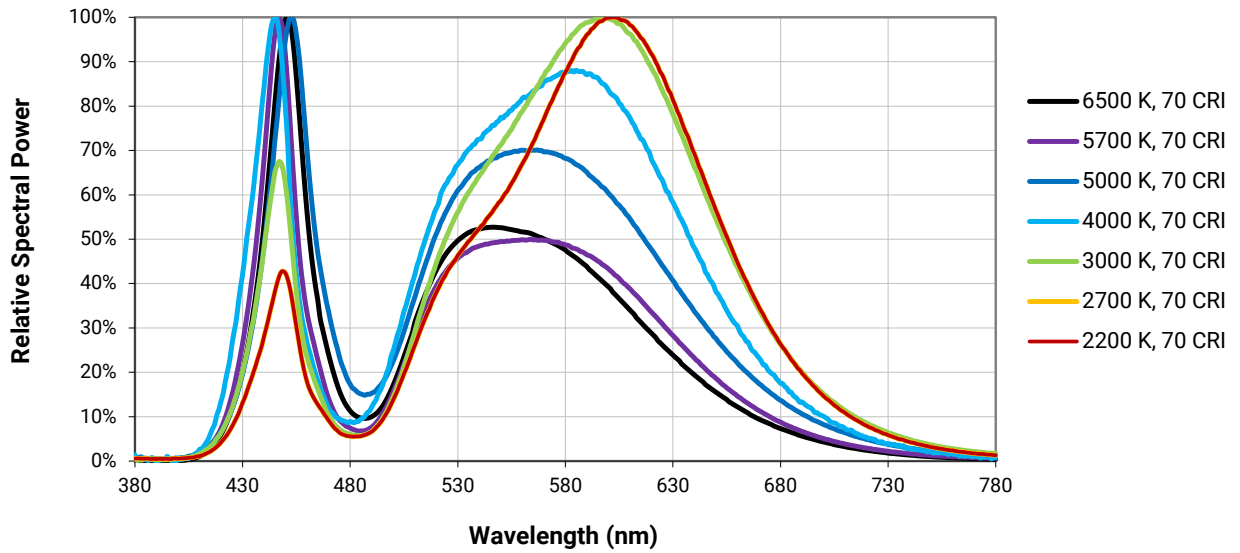

TYPICAL SPATIAL DISTRIBUTION

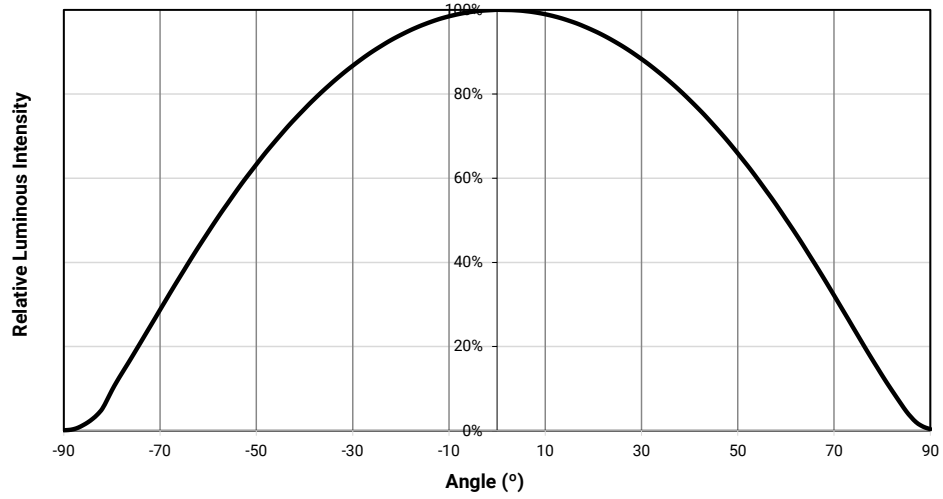

PERFORMANCE GROUPS - LUMINOUS FLUX (T_j = 25 °C)

J Series 5050 LEDs are tested for luminous flux at the following current levels.

JK5050 LED	Tested For Luminous Flux At
6 V	180 mA
24 V	45 mA

JR5050 LED	Tested For Luminous Flux At
6 V	400 mA
9 V	260 mA
24 V	100 mA
30 V	80 mA
36 V	65 mA

Once tested, J Series JK5050 LEDs are placed into one of the following luminous-flux groups.

Group Code	Minimum Luminous Flux (lm)	Maximum Luminous Flux (lm)
G1	130	140
G3	140	150
G5	150	160
H1	160	170
H3	170	180
H5	180	190
J1	190	200
J3	200	210
J5	210	220
K1	220	230
K3	230	240

Once tested, J Series JR5050 LEDs are placed into one of the following luminous-flux groups.

Group Code	Minimum Luminous Flux (lm)	Maximum Luminous Flux (lm)
P4	250	300
Q2	300	350
Q4	350	400
R2	400	450
R4	450	500
S2	500	550

PERFORMANCE GROUPS - FORWARD VOLTAGE ($T_j = 25\text{ }^\circ\text{C}$)

J Series 5050 LEDs are tested for forward voltage and placed into one of the following voltage bins.

The following voltage bins are indicated in the Forward Voltage Bin field in the bin code for JR5050 and JR5050B 6-V LEDs.

Voltage Bin	Minimum Forward Voltage (V)	Maximum Forward Voltage (V)
BM	5.4	5.6
BN	5.6	5.8
BP	5.8	6.0
BQ	6.0	6.2

The following voltage bins are indicated in the Forward Voltage Bin field in the bin code for JR5050 9-V LEDs.

Voltage Bin	Minimum Forward Voltage (V)	Maximum Forward Voltage (V)
CT	8.0	8.5
CU	8.5	9.0
CV	9.0	9.5

The following voltage bins are indicated in the Forward Voltage Bin field in the bin code for JK5050B 24-V LEDs.

Voltage Bin	Minimum Forward Voltage (V)	Maximum Forward Voltage (V)
HL	20.8	21.6
HM	21.6	22.4
HN	22.4	23.2

The following voltage bins are indicated in the Forward Voltage Bin field in the bin code for JR5050 and JR5050B 24-V LEDs.

Voltage Bin	Minimum Forward Voltage (V)	Maximum Forward Voltage (V)
HC	21.5	22.5
HD	22.5	23.5
HE	23.5	24.5

The following voltage bins are indicated in the Forward Voltage Bin field in the bin code for JR5050B 30-V LEDs.

Voltage Bin	Minimum Forward Voltage (V)	Maximum Forward Voltage (V)
KE	27	28
KF	28	29
KG	29	30

PERFORMANCE GROUPS - FORWARD VOLTAGE - CONTINUED ($T_j = 25\text{ }^\circ\text{C}$)

The following voltage bins are indicated in the Forward Voltage Bin field in the bin code for JR5050 36-V LEDs.

Voltage Bin	Minimum Forward Voltage (V)	Maximum Forward Voltage (V)
NF	33	34
NG	34	35
NH	35	36

PERFORMANCE GROUPS - CHROMATICITY ($T_j = 85\text{ }^\circ\text{C}$)

J Series 5050 LEDs are tested for chromaticity and placed into one of the regions defined by the following bounding coordinates.

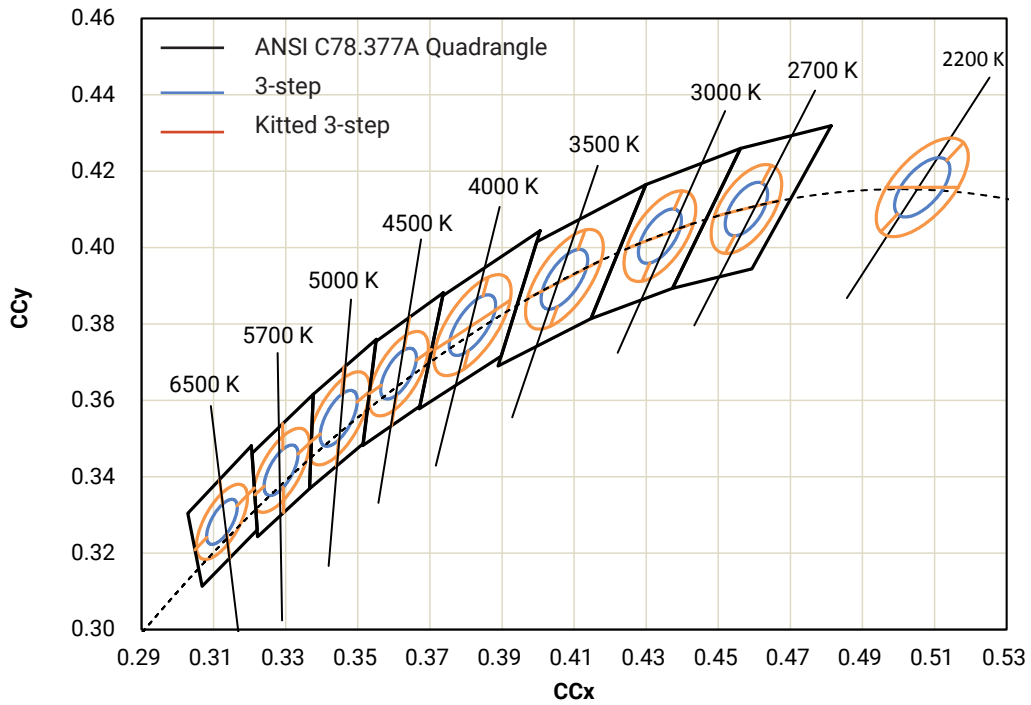

PERFORMANCE GROUPS - CHROMATICITY - CONTINUED ($T_j = 85\text{ }^\circ\text{C}$)

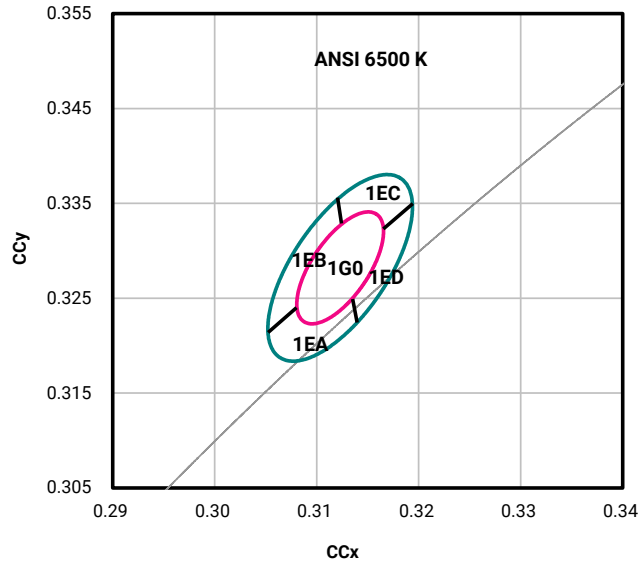

CCT	MacAdam Ellipse	Included Bins	Center Point		Major Axis	Minor Axis	Rotation Angle (°)
			x	y	a	b	
6500 K	3-step	1G0	0.3123	0.3282	0.00669	0.00285	58.57
	Kitted 3-step	1G0, 1EA, 1EB, 1EC, 1ED	0.3123	0.3282	0.01115	0.00475	58.57

PERFORMANCE GROUPS - CHROMATICITY - CONTINUED ($T_j = 85\text{ }^\circ\text{C}$)

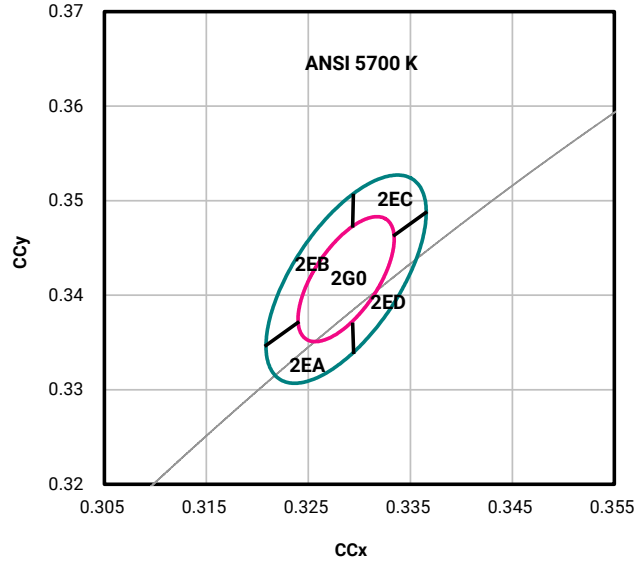

CCT	MacAdam Ellipse	Included Bins	Center Point		Major Axis	Minor Axis	Rotation Angle (°)
			x	y	a	b	
5700 K	3-step	2G0	0.3287	0.3417	0.00746	0.00320	59.09
	Kitted 3-step	2G0, 2EA, 2EB, 2EC, 2ED	0.3287	0.3417	0.01243	0.00533	59.09

PERFORMANCE GROUPS - CHROMATICITY - CONTINUED ($T_j = 85\text{ }^\circ\text{C}$)

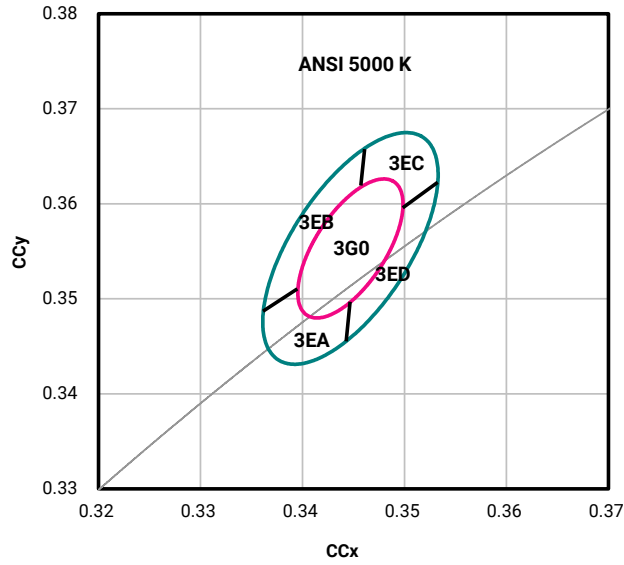

CCT	MacAdam Ellipse	Included Bins	Center Point		Major Axis	Minor Axis	Rotation Angle (°)
			x	y	a	b	
5000 K	3-step	3G0	0.3447	0.3553	0.00822	0.00354	59.62
	Kitted 3-step	3G0, 3EA, 3EB, 3EC, 3ED	0.3447	0.3553	0.01370	0.00590	59.62

PERFORMANCE GROUPS - CHROMATICITY - CONTINUED ($T_j = 85\text{ }^\circ\text{C}$)

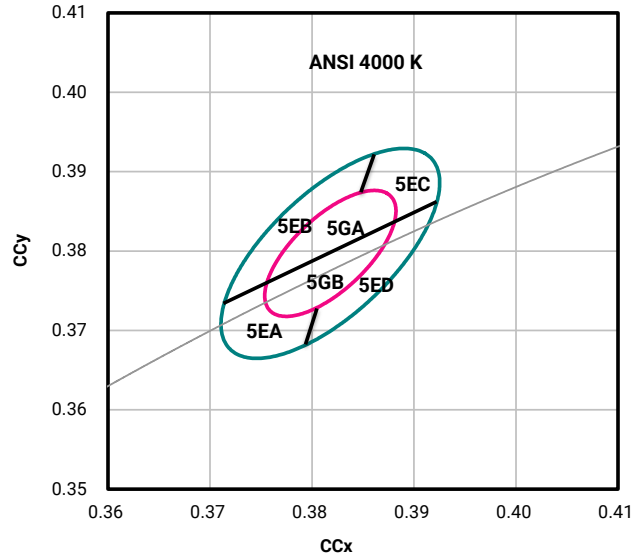

CCT	MacAdam Ellipse	Included Bins	Center Point		Major Axis	Minor Axis	Rotation Angle (°)
			x	y	a	b	
4000 K	3-step	5GA, 5GB	0.3818	0.3797	0.00939	0.00402	53.72
	Kitted 3-step	5GA, 5GB, 5EA, 5EB, 5EC, 5ED	0.3818	0.3797	0.01565	0.00670	53.72

PERFORMANCE GROUPS - CHROMATICITY - CONTINUED ($T_j = 85\text{ }^\circ\text{C}$)

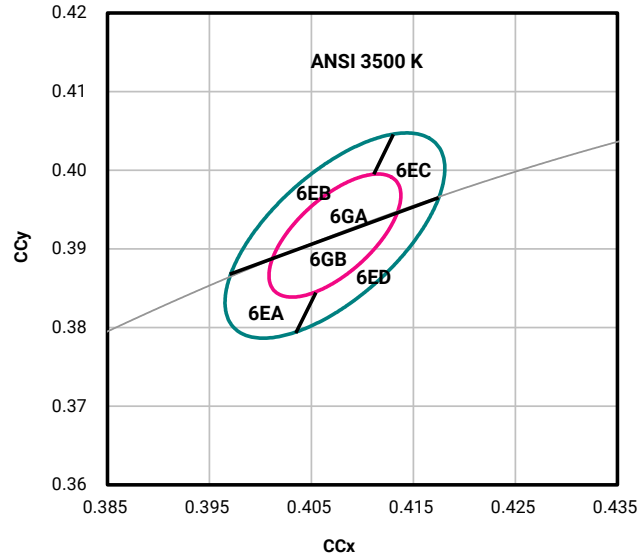

CCT	MacAdam Ellipse	Included Bins	Center Point		Major Axis	Minor Axis	Rotation Angle (°)
			x	y	a	b	
3500 K	3-step	6GA, 6GB	0.4073	0.3917	0.00927	0.00414	54.00
	Kitted 3-step	6GA, 6GB, 6EA, 6EB, 6EC, 6ED	0.4073	0.3917	0.01545	0.00690	54.00

PERFORMANCE GROUPS - CHROMATICITY - CONTINUED ($T_j = 85\text{ }^\circ\text{C}$)

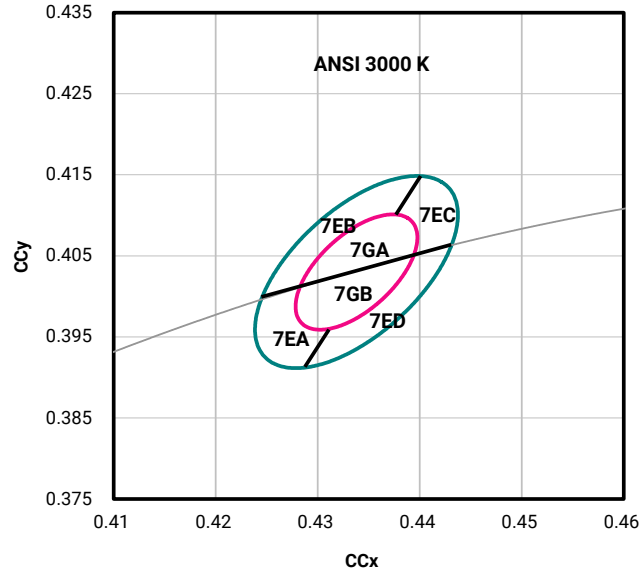

CCT	MacAdam Ellipse	Included Bins	Center Point		Major Axis	Minor Axis	Rotation Angle (°)
			x	y	a	b	
3000 K	3-step	7GA, 7GB	0.4338	0.4030	0.00834	0.00408	53.22
	Kitted 3-step	7GA, 7GB, 7EA, 7EB, 7EC, 7ED	0.4338	0.4030	0.01390	0.00680	53.22

PERFORMANCE GROUPS - CHROMATICITY - CONTINUED ($T_j = 85\text{ °C}$)

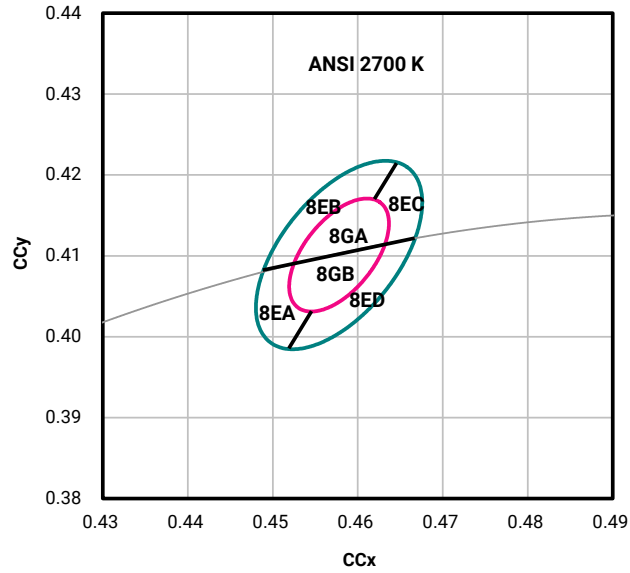

CCT	MacAdam Ellipse	Included Bins	Center Point		Major Axis	Minor Axis	Rotation Angle (°)
			x	y	a	b	
2700 K	3-step	8GA, 8GB	0.4578	0.4101	0.00810	0.00420	53.70
	Kitted 3-step	8GA, 8GB, 8EA, 8EB, 8EC, 8ED	0.4578	0.4101	0.01350	0.00700	53.70

PERFORMANCE GROUPS - CHROMATICITY - CONTINUED ($T_j = 85\text{ }^\circ\text{C}$)

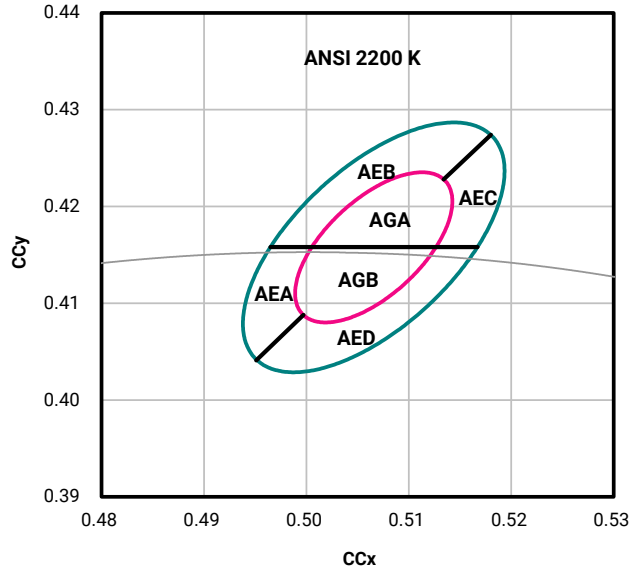

CCT	MacAdam Ellipse	Included Bins	Center Point		Major Axis	Minor Axis	Rotation Angle (°)
			x	y	a	b	
2200 K	3-step	AGA, AGB	0.5066	0.4158	0.0098	0.0048	45.5
	Kitted 3-step	AGA, AGB, AEA, AEB, AEC, AED	0.5066	0.4158	0.0163	0.0080	45.5

REFLOW SOLDERING CHARACTERISTICS

In testing, Cree Venture has found J Series 5050 LEDs to be compatible with JEDEC J-STD-020C, using the parameters listed below. As a general guideline, Cree Venture recommends that users follow the recommended soldering profile provided by the manufacturer of the solder paste used, and therefore it is the lamp or luminaire manufacturer’s responsibility to determine applicable soldering requirement.

Note that this general guideline may not apply to all PCB designs and configurations of reflow soldering equipment.

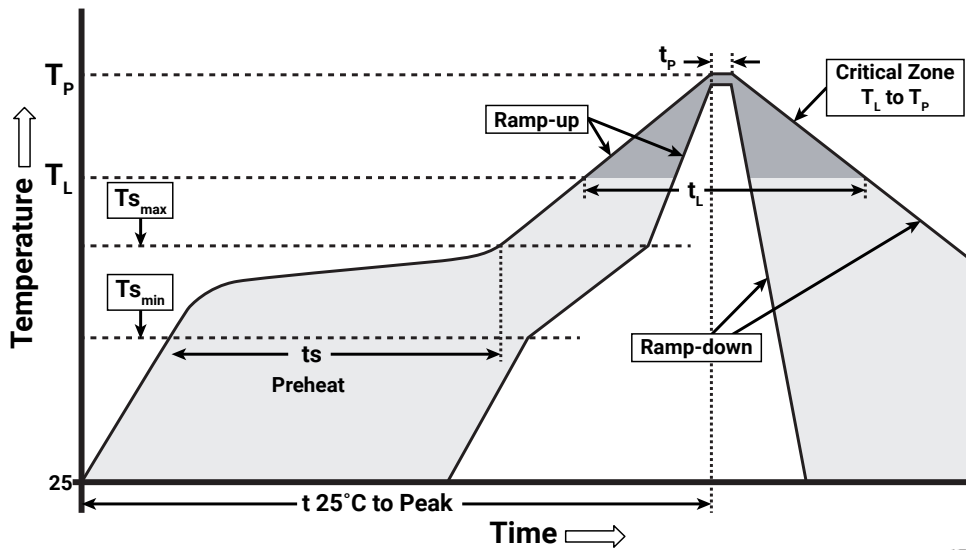

IPC/JEDEC J-STD-020C

Profile Feature	Lead-Free Solder
Temperature Min. ($T_{s_{min}}$)	150 °C
Temperature Max. ($T_{s_{max}}$)	200 °C
Time (t_s) from $T_{s_{min}}$ to $T_{s_{max}}$	60-120 seconds
Ramp-Up Rate (T_L to T_P)	3 °C/second
Liquidus Temperature (T_L)	217 °C
Time (t_L) Maintained Above T_L	60-150 seconds
Peak Package Body Temperature (T_p)	260 °C max.
Time (t_p) Within 5 °C of the Specified Classification Temperature (T_c)	30 seconds max.
Ramp-Down Rate (T_p to T_L)	6 °C/second max.
Time 25 °C to Peak Temperature	8 minutes max.

Note: All temperatures refer to the topside of the package, measured on the package body surface.

NOTES

Measurements

The luminous flux, radiant power, chromaticity, forward voltage and CRI measurements in this document are binning specifications only and solely represent product measurements as of the date of shipment. These measurements will change over time based on a number of factors that are not within Cree Venture's control and are not intended or provided as operational specifications for the products. Calculated values are provided for informational purposes only and are not intended or provided as specifications.

Pre-Release Qualification Testing

Please read the [J Series Reliability Overview](#) for the details of the pre-release qualification testing for J Series LEDs.

Lumen Maintenance

Cree Venture uses standardized IES LM-80-08 and TM-21-11 methods for collecting long-term data and extrapolating LED lumen maintenance. For information on the specific LM-80 data sets available for this LED, refer to the public [J Series LM-80 results document](#).

Please read the [Thermal Management application note](#) for details on how thermal design, ambient temperature, and drive current affect the LED junction temperature.

Moisture Sensitivity

Cree Venture recommends keeping J Series 5050 LEDs in the provided, resealable moisture-barrier packaging (MBP) until immediately prior to soldering. Unopened MBP that contains J Series 5050 LEDs does not need special storage for moisture sensitivity.

Once the MBP is opened, J Series 5050 LEDs should be handled and stored as MSL 3 per JEDEC J-STD-033, meaning they have limited exposure time before damage to the LED may occur during the soldering operation. The table on the right specifies the maximum exposure time in days depending on temperature and humidity conditions. LEDs with exposure time longer than the specified maximums must be baked according to the baking conditions listed below.

Moisture Sensitivity Level	Temp.	Maximum Percent Relative Humidity				
		50%	60%	70%	80%	90%
Level 3	35 °C	8	5	1	0.5	0.5
Level 3	30 °C	11	7	1	1	1
Level 3	25 °C	14	10	2	1	1
Level 3	20 °C	20	13	2	1	1

Baking Conditions

It is not necessary to bake all J Series 5050 LEDs. Only the LEDs that meet all of the following criteria must be baked:

1. LEDs that have been removed from the original MBP.
2. LEDs that have been exposed to a humid environment longer than listed in the Moisture Sensitivity section above.
3. LEDs that have not been soldered.

LEDs should be baked at 60 °C for 24 hours. LEDs may be baked in the original reels. Remove LEDs from the MBP before baking. Do not bake parts at temperatures higher than 60 °C. This baking operation resets the exposure time as defined in the Moisture Sensitivity section above.

NOTES - CONTINUED

RoHS Compliance

The levels of RoHS restricted materials in this product are below the maximum concentration values (also referred to as the threshold limits) permitted for such substances, or are used in an exempted application, in accordance with EU Directive 2011/65/EC (RoHS2), as implemented January 2, 2013. RoHS Declarations for this product can be obtained from your Cree Venture representative or from the [Product Ecology](#) section of the Cree LED website.

REACH Compliance

REACH substances of very high concern (SVHCs) information is available for this product. Since the European Chemical Agency (ECHA) has published notice of their intent to frequently revise the SVHC listing for the foreseeable future, please contact a Cree LED representative to insure you get the most up-to-date REACH SVHC Declaration. REACH banned substance information (REACH Article 67) is also available upon request.

UL® Recognized Component

This product meets the requirements to be considered a UL Recognized Component with Level 4 enclosure consideration. The LED package or a portion thereof has been investigated as a fire and electrical enclosure per ANSI/UL 8750.

Vision Advisory

WARNING: Do not look at an exposed lamp in operation. Eye injury can result. For more information about LEDs and eye safety, please refer to the [J Series LED Eye Safety application note](#).

MECHANICAL DIMENSIONS

Vias, if present, are not shown on these drawings.
 All measurements are ± 0.2 mm unless otherwise indicated.

Round LES

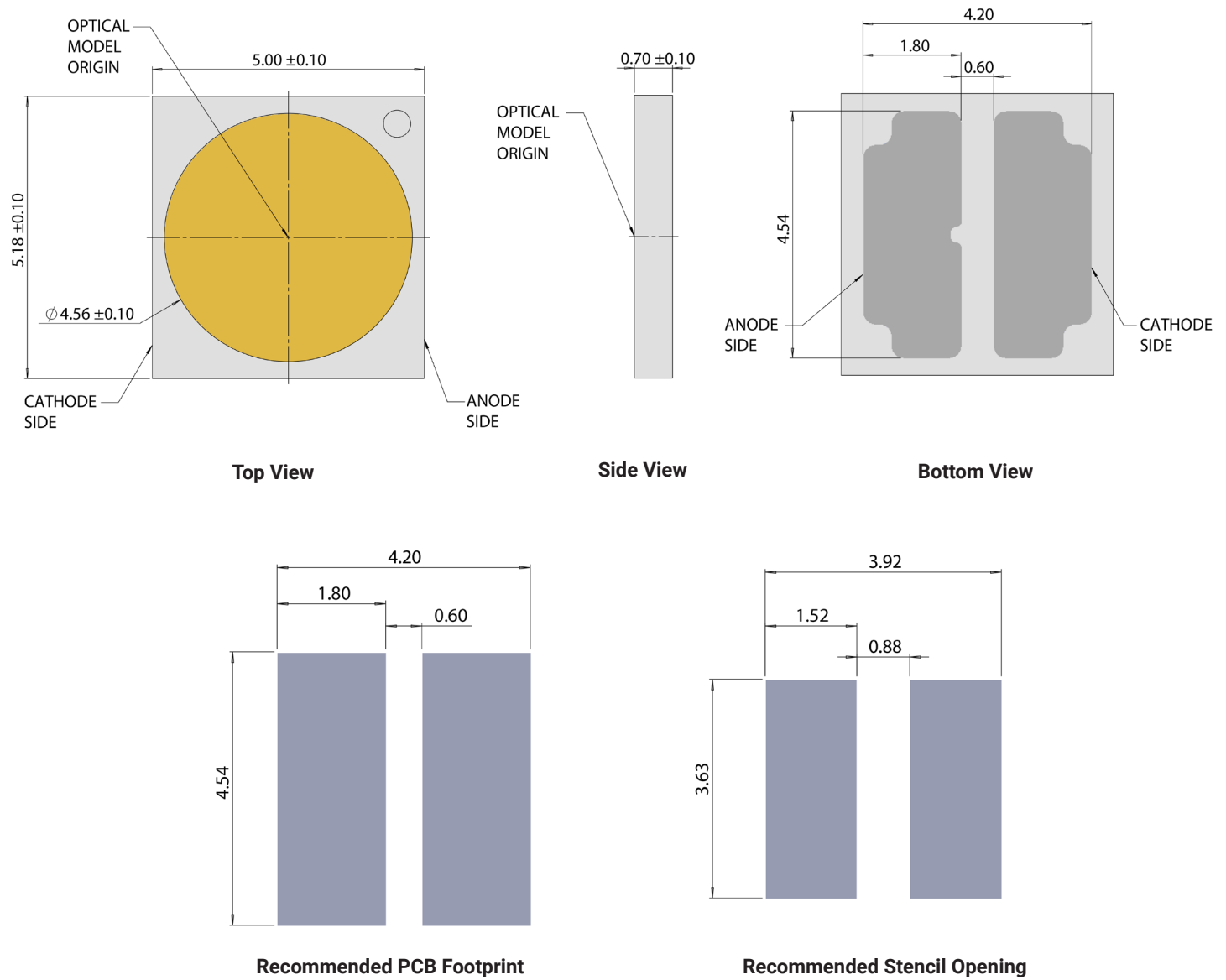

MECHANICAL DIMENSIONS - CONTINUED

Vias, if present, are not shown on these drawings.

Applicable to JR5050B 6-V & 30-V K Class LEDs and JK5050B 6-V & 24-V H Class LEDs

All measurements are ± 0.2 mm unless otherwise indicated.

Square LES

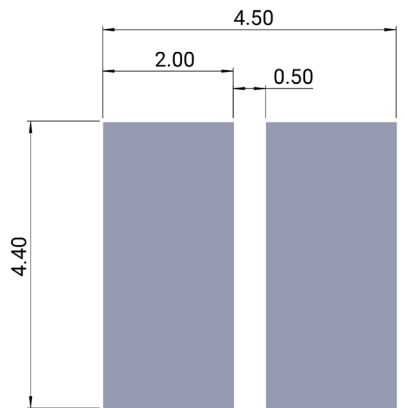
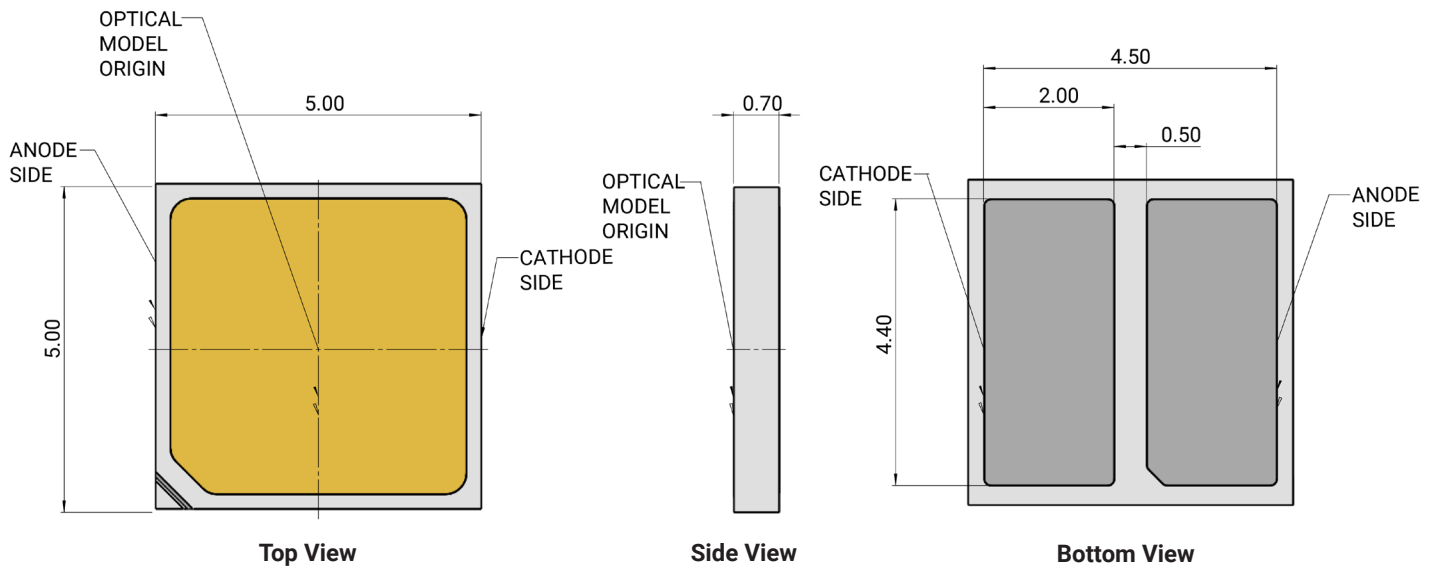

Recommended PCB Footprint

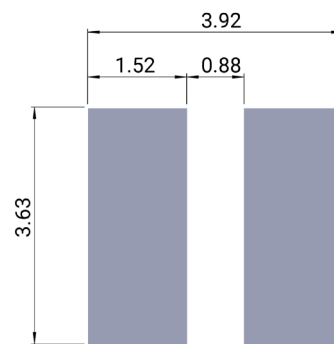

Recommended Stencil Opening

TAPE & REEL

All Cree Venture carrier tapes conform to EIA-481D, Automated Component Handling Systems Standard.

All dimensions in mm.

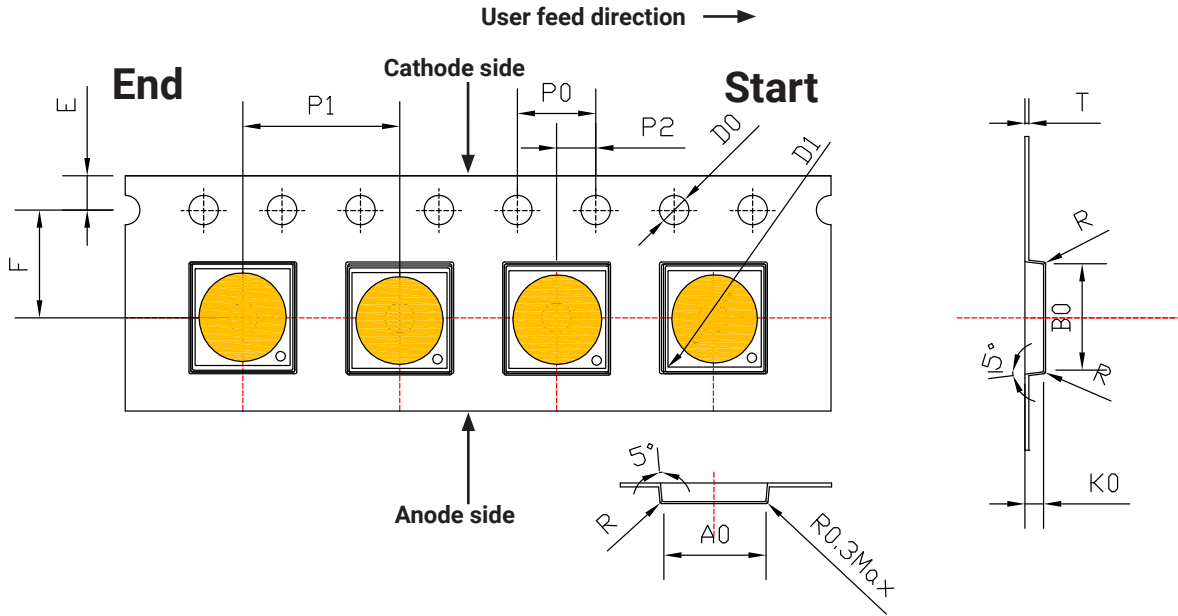

Item	A0	B0	K0	P0	P1	P2	T	E	F	D0	D1	W	R
Dim.	5.40±0.10	5.20±0.10	0.95±0.10	4.00±0.10	8.00±0.10	2.0±0.10	0.20±0.05	1.75±0.10	5.50±0.05	1.50 ^{+0.1} ₋₀	1.50±0.10	12.0±0.2	5°

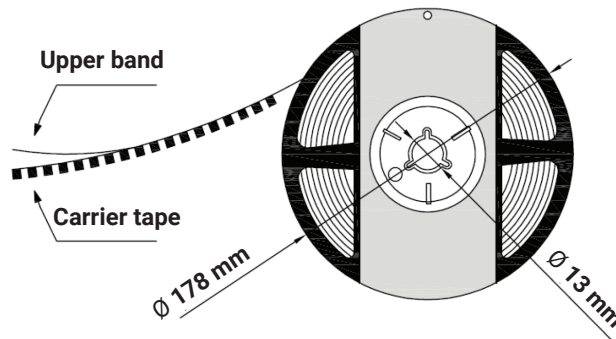
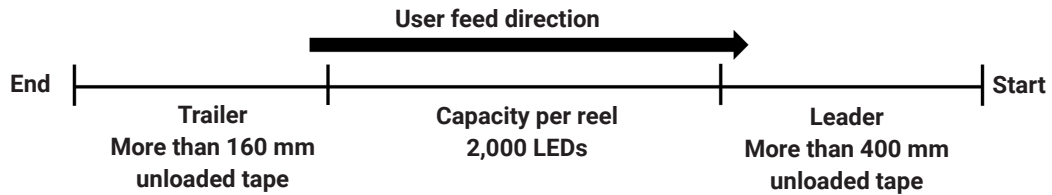

PACKAGING

Unpackaged Reel

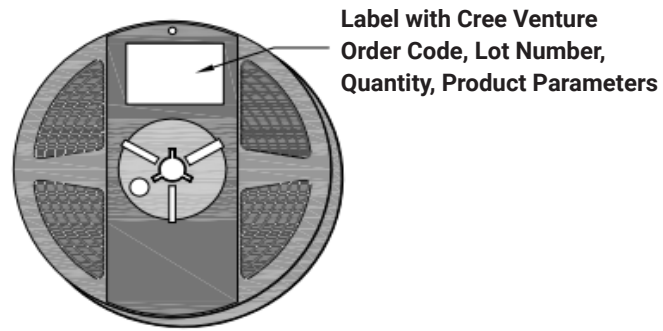

Packaged Reel

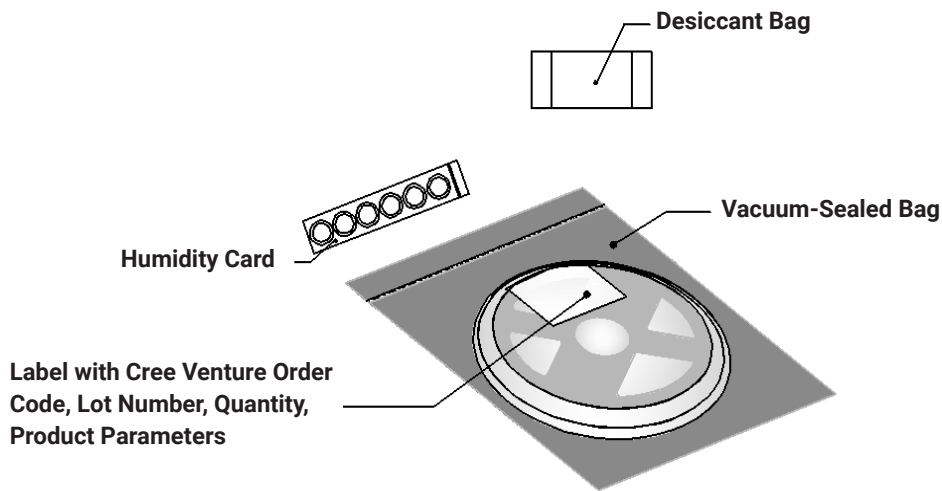

PACKAGING - CONTINUED

J Series 5050 LEDs are packaged in boxes for shipment. Box sizes and the number of reels per box are as follows.

Box	Box Dimensions	Maximum Number of Reels per Box
1	250 x 210 x 30 mm	2
2	250 x 210 x 50 mm	3
3	530 x 230 x 275 mm	32
4	530 x 443 x 275 mm	64

Each box has at least one label (shown as a white square in the diagrams below) showing the order code, lot number, quantity, and product parameters.

Box 1

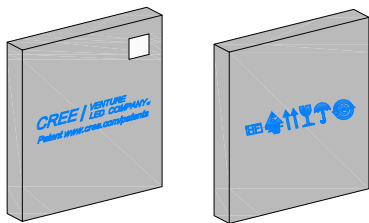

Box 2

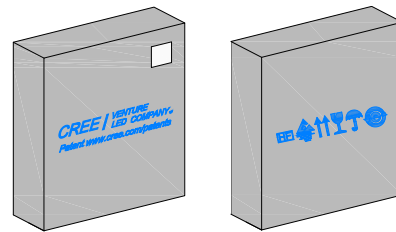

Box 3

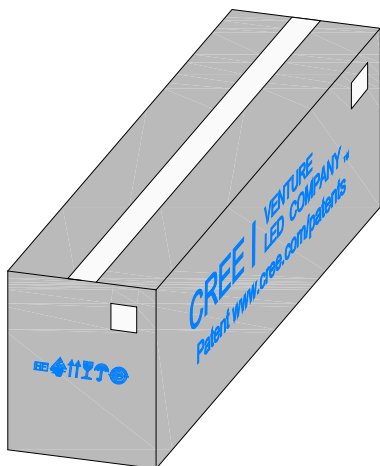

Box 4

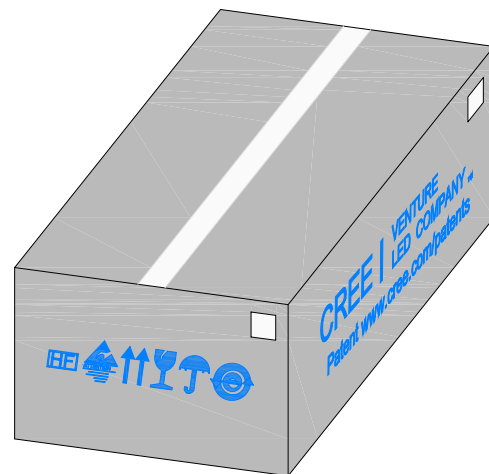

Mouser Electronics

Authorized Distributor

Click to View Pricing, Inventory, Delivery & Lifecycle Information:

Cree LED:

[JR5050AWT-P-B40EB0000-N0000001](#) [JR5050AWT-P-B40EH0000-N0000001](#) [JR5050AWT-P-H30EB0000-N0000001](#)
[JR5050AWT-Q-B27EC0000-N0000001](#) [JR5050AWT-Q-B27EN0000-N0000001](#) [JR5050AWT-Q-B30EC0000-](#)
[N0000001](#) [JR5050AWT-Q-B30EN0000-N0000001](#) [JR5050AWT-Q-B35EC0000-N0000001](#) [JR5050AWT-Q-](#)
[B35EN0000-N0000001](#) [JR5050AWT-Q-U57EH0000-N0000001](#) [JR5050AWT-Q-U65EB0000-N0000001](#) [JR5050AWT-](#)
[Q-U65EH0000-N0000001](#) [JR5050AWT-Q-U35EH0000-N0000001](#) [JR5050AWT-Q-U40EB0000-N0000001](#)
[JR5050AWT-Q-U40EH0000-N0000001](#) [JR5050AWT-Q-U50EB0000-N0000001](#) [JR5050AWT-Q-U50EH0000-N0000001](#)
[JR5050AWT-Q-U57EB0000-N0000001](#) [JR5050AWT-Q-H65EH0000-N0000001](#) [JR5050AWT-Q-U27EB0000-](#)
[N0000001](#) [JR5050AWT-Q-U27EH0000-N0000001](#) [JR5050AWT-Q-U30EB0000-N0000001](#) [JR5050AWT-Q-](#)
[U30EH0000-N0000001](#) [JR5050AWT-Q-U35EB0000-N0000001](#) [JR5050AWT-Q-H40EH0000-N0000001](#) [JR5050AWT-](#)
[Q-H50EB0000-N0000001](#) [JR5050AWT-Q-H50EH0000-N0000001](#) [JR5050AWT-Q-H57EB0000-N0000001](#)
[JR5050AWT-Q-H57EH0000-N0000001](#) [JR5050AWT-Q-H65EB0000-N0000001](#) [JR5050AWT-Q-H27EB0000-N0000001](#)
[JR5050AWT-Q-H27EH0000-N0000001](#) [JR5050AWT-Q-H30EH0000-N0000001](#) [JR5050AWT-Q-H35EB0000-](#)
[N0000001](#) [JR5050AWT-Q-H35EH0000-N0000001](#) [JR5050AWT-Q-H40EB0000-N0000001](#) [JR5050AWT-Q-](#)
[B50EB0000-N0000001](#) [JR5050AWT-Q-B50EH0000-N0000001](#) [JR5050AWT-Q-B57EB0000-N0000001](#) [JR5050AWT-](#)
[Q-B57EH0000-N0000001](#) [JR5050AWT-Q-B65EB0000-N0000001](#) [JR5050AWT-Q-B65EH0000-N0000001](#)
[JR5050AWT-Q-B27EB0000-N0000001](#) [JR5050AWT-Q-B27EH0000-N0000001](#) [JR5050AWT-Q-B30EB0000-N0000001](#)
[JR5050AWT-Q-B30EH0000-N0000001](#) [JR5050AWT-Q-B35EB0000-N0000001](#) [JR5050AWT-Q-B35EH0000-](#)
[N0000001](#) [JR5050AWT-P-U50EB0000-N0000001](#) [JR5050AWT-P-U50EH0000-N0000001](#) [JR5050AWT-P-](#)
[U57EB0000-N0000001](#) [JR5050AWT-P-U57EH0000-N0000001](#) [JR5050AWT-P-U65EB0000-N0000001](#) [JR5050AWT-](#)
[P-U65EH0000-N0000001](#) [JR5050AWT-P-U30EB0000-N0000001](#) [JR5050AWT-P-U30EH0000-N0000001](#)
[JR5050AWT-P-U35EB0000-N0000001](#) [JR5050AWT-P-U35EH0000-N0000001](#) [JR5050AWT-P-U40EB0000-N0000001](#)
[JR5050AWT-P-U40EH0000-N0000001](#) [JR5050AWT-P-H57EB0000-N0000001](#) [JR5050AWT-P-H57EH0000-](#)
[N0000001](#) [JR5050AWT-P-H65EB0000-N0000001](#) [JR5050AWT-P-H65EH0000-N0000001](#) [JR5050AWT-P-](#)
[U27EB0000-N0000001](#) [JR5050AWT-P-U27EH0000-N0000001](#) [JR5050AWT-P-H35EB0000-N0000001](#) [JR5050AWT-](#)
[P-H35EH0000-N0000001](#) [JR5050AWT-P-H40EB0000-N0000001](#) [JR5050AWT-P-H40EH0000-N0000001](#)
[JR5050AWT-P-H50EB0000-N0000001](#) [JR5050AWT-P-H50EH0000-N0000001](#) [JR5050AWT-P-B57EH0000-N0000001](#)

[JR5050AWT-P-B65EB0000-N0000001](#) [JR5050AWT-P-B65EH0000-N0000001](#) [JR5050AWT-P-H27EB0000-N0000001](#)
[JR5050AWT-P-H27EH0000-N0000001](#) [JR5050AWT-P-H30EH0000-N0000001](#) [JR5050AWT-P-B30EH0000-](#)
[N0000001](#) [JR5050AWT-P-B35EB0000-N0000001](#) [JR5050AWT-P-B35EH0000-N0000001](#) [JR5050AWT-P-B50EB0000-](#)
[N0000001](#) [JR5050AWT-P-B50EH0000-N0000001](#) [JR5050AWT-P-B57EB0000-N0000001](#) [JR5050AWT-Q-](#)
[U57EN0000-N0000001](#) [JR5050AWT-Q-U65EC0000-N0000001](#) [JR5050AWT-Q-U65EN0000-N0000001](#) [JR5050AWT-](#)
[P-B27EB0000-N0000001](#) [JR5050AWT-P-B27EH0000-N0000001](#) [JR5050AWT-P-B30EB0000-N0000001](#) [JR5050AWT-](#)
[Q-U50EC0000-N0000001](#) [JR5050AWT-Q-U50EN0000-N0000001](#) [JR5050AWT-Q-U57EC0000-N0000001](#)
[JR5050AWT-Q-U30EN0000-N0000001](#) [JR5050AWT-Q-U35EC0000-N0000001](#) [JR5050AWT-Q-U35EN0000-N0000001](#)
[JR5050AWT-Q-U40EC0000-N0000001](#) [JR5050AWT-Q-U40EN0000-N0000001](#) [JR5050AWT-Q-H57EN0000-](#)
[N0000001](#) [JR5050AWT-Q-H65EC0000-N0000001](#)