

MMBT3904-HF (NPN)

RoHS Device
Halogen Free

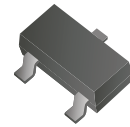

Features

- Epitaxial planar die construction
- As complementary type, the PNP transistor MMBT3904-HF is recommended

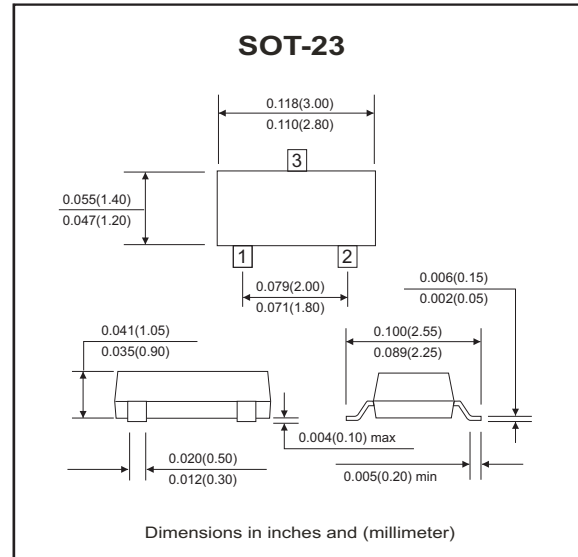
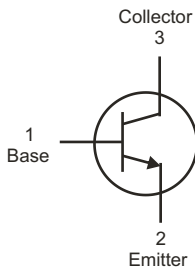

Maximum Ratings (at TA=25°C unless otherwise noted)

Parameter	Symbol	Min	Typ	Max	Unit
Collector-Base voltage	V _{CB0}			60	V
Collector-Emitter voltage	V _{CEO}			40	V
Emitter-Base voltage	V _{EBO}			6	V
Collector current-Continuous	I _c			0.2	A
Collector dissipation	P _C			0.2	W
Thermal resistance, junction to ambient	R _{θJA}			625	°C/W
Storage temperature and junction temperature	T _{STG} , T _J	-55		+150	°C

Electrical Characteristics (at TA=25°C unless otherwise noted)

Parameter	Conditions	Symbol	Min	Max	Unit
Collector-Base breakdown voltage	I _c = 100μA , I _E = 0	V _{(BR)CBO}	60		V
Collector-Emitter breakdown voltage	I _c = 1mA , I _B = 0	V _{(BR)CEO}	40		V
Emitter-Base breakdown voltage	I _E = 100μA , I _C = 0	V _{(BR)EBO}	6		V
Collector cut-off current	V _{CB} = 60V , I _E = 0	I _{CBO}		0.1	μA
Collector cut-off current	V _{CE} = 30V , V _{BE(off)} = 3V	I _{CEx}		50	nA
Emitter cut-off current	V _{EB} = 5V , I _C = 0	I _{EBO}		0.1	μA
DC current gain	V _{CE} = 1V , I _C = 10mA	h _{FE(1)}	100	400	
	V _{CE} = 1V , I _C = 50mA	h _{FE(2)}	60		
Collector-Emitter saturation voltage	I _C = 50mA , I _B = 5mA	V _{CE(sat)}		0.3	V
Base-Emitter saturation voltage	I _C = 50mA , I _B = 5mA	V _{BE(sat)}		0.95	V
Transition frequency	V _{CE} = 20V , I _C = 10mA f = 100MHz	f _T	300		Mhz
Delay time	V _{CC} = 3.0V , V _{BE} = -0.5V	t _d		35	nS
Rise time	I _C = 10mA , I _{B1} = 1.0mA	t _r		35	nS
Storage time	V _{CC} = 3.0V , I _C = 10mA	t _s		200	nS
Fall time	I _{B1} = I _{B2} = 1.0mA	t _f		50	nS

RATING AND CHARACTERISTIC CURVES (MMBT3904-HF)

Fig.1 Typical pulsed current gain V.S. Collector current

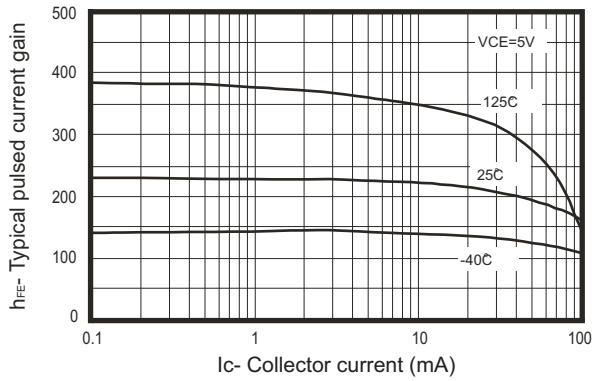

Fig.2 Collector-Emitter saturation voltage V.S. Collector current

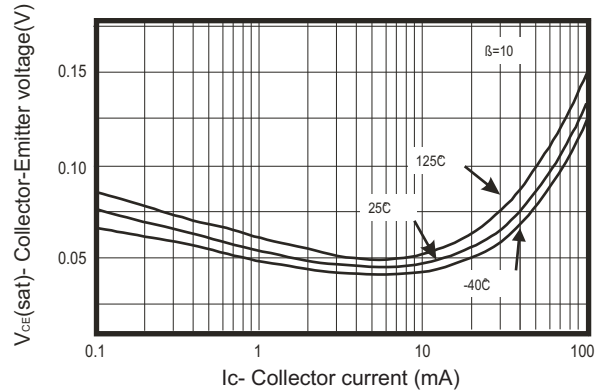

Fig.3 Base-Emitter saturation voltage V.S. Collector current

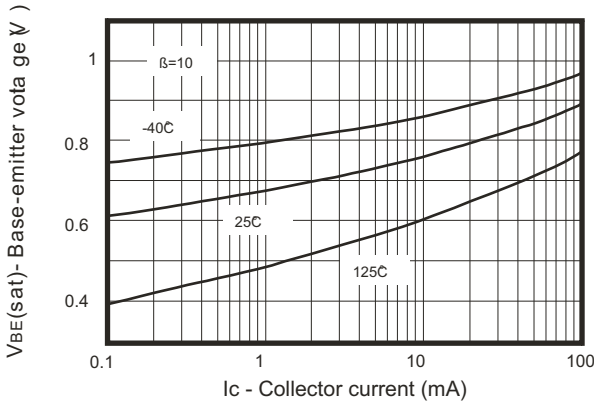

Fig.4 Base-Emitter ON voltage V.S. Collector current

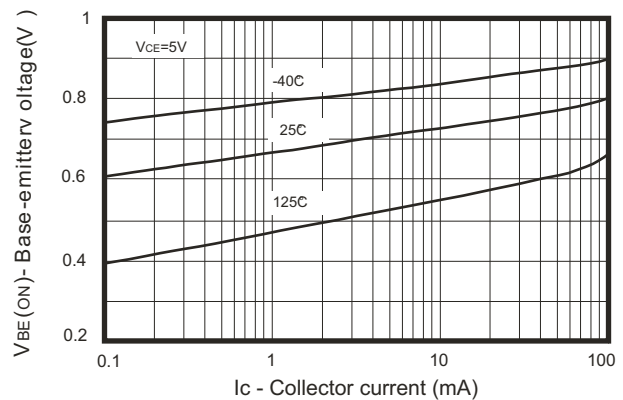

Fig.5 Collector-cutoff current V.S. Ambient temperature

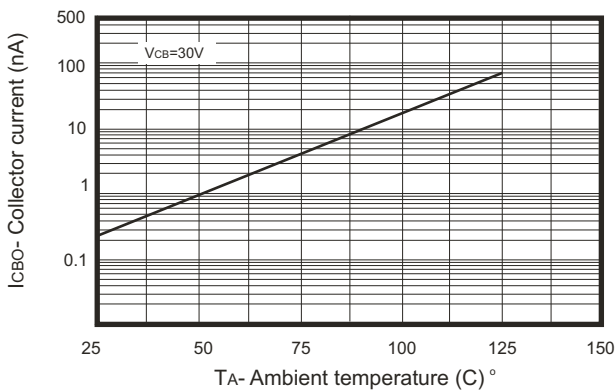
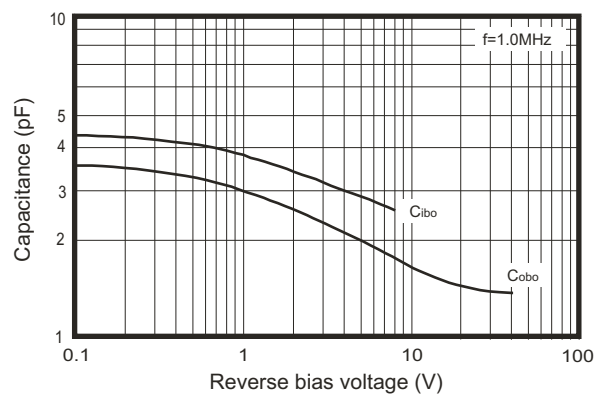
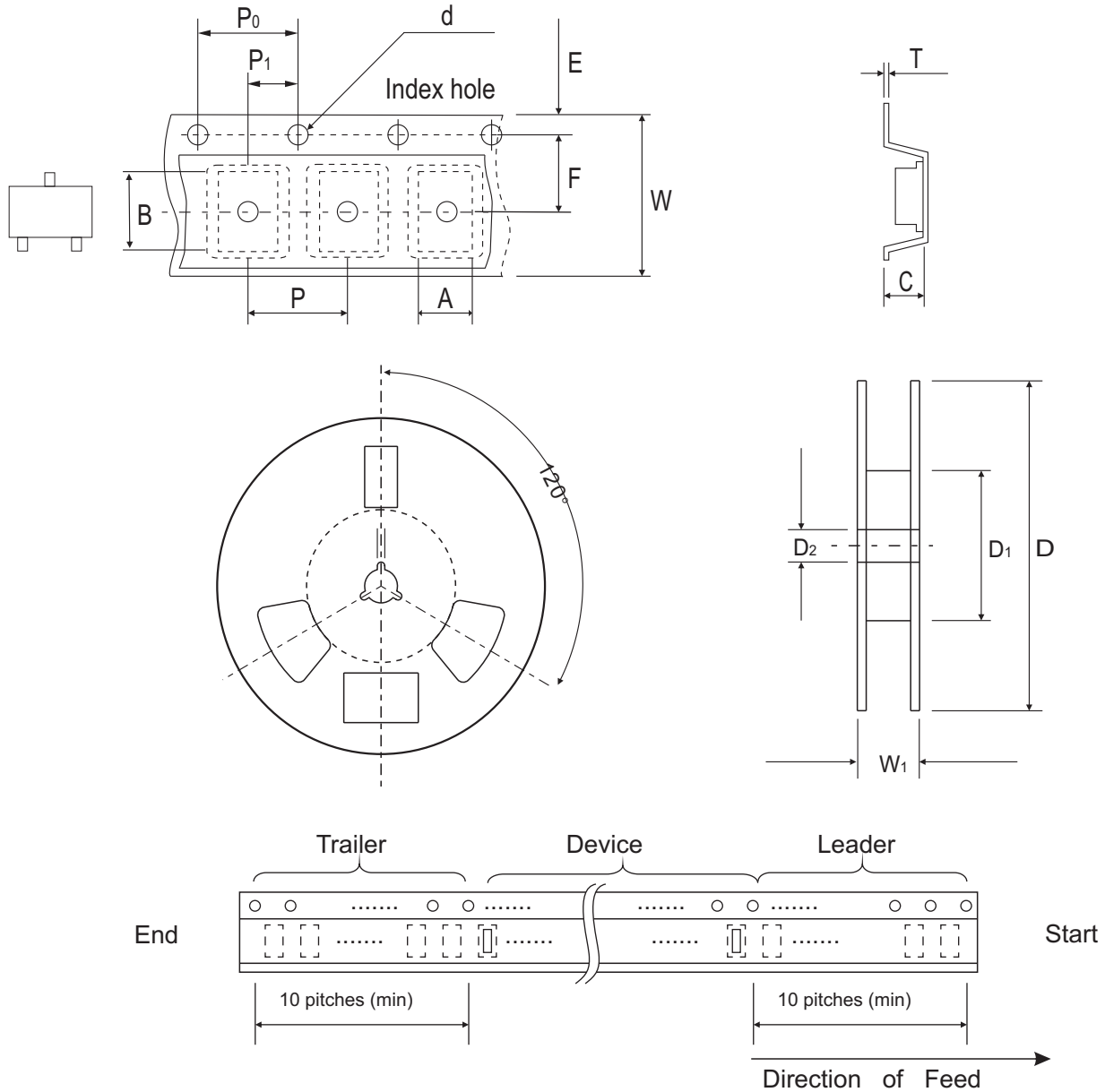

Fig.6 Capacitance V.S. Reverse bias voltage



Reel Taping Specification



SOT-23	SYMBOL	A	B	C	d	D	D ₁	D ₂
	(mm)	3.10 ± 0.10	2.85 ± 0.10	1.40 ± 0.10	1.55 ± 0.10	178 ± 1	50.0 MIN.	13.0 ± 0.20
	(inch)	0.122 ± 0.004	0.112 ± 0.004	0.055 ± 0.004	0.061 ± 0.004	7.008 ± 0.04	1.969 MIN.	0.512 ± 0.008

SOT-23	SYMBOL	E	F	P	P ₀	P ₁	W	W ₁
	(mm)	1.75 ± 0.10	3.50 ± 0.05	4.00 ± 0.10	4.00 ± 0.10	2.00 ± 0.05	8.00 ± 0.30	14.4 MAX.
	(inch)	0.069 ± 0.004	0.138 ± 0.002	0.157 ± 0.004	0.157 ± 0.004	0.079 ± 0.004	0.315 ± 0.008	0.567 MAX.

Marking Code

Park Number	Marking Code
MMBT3904-HF	1AM



Suggested PAD Layout

SIZE	SOT-23	
	(mm)	(inch)
A	0.80	0.031
B	0.95	0.037
C	0.95	0.037
D	2.02	0.080
E	3.03	0.120

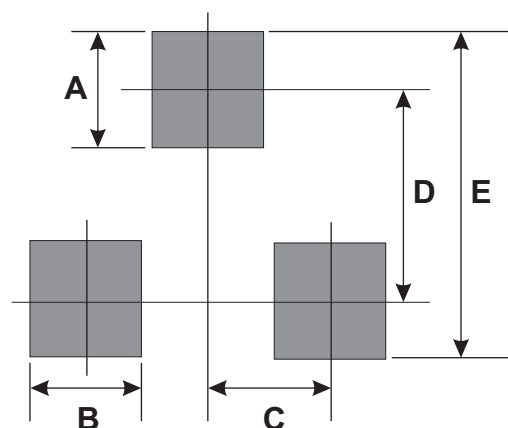

Standard Packaging

Case Type	Qty per Reel	Reel Size
	(Pcs)	(inch)
SOT-23	3000	7

Mouser Electronics

Authorized Distributor

Click to View Pricing, Inventory, Delivery & Lifecycle Information:

[Comchip Technology:](#)

[MMBT3904-HF](#)