



[Evaluation Kit Available](#)



[Design Resources](#)



[Tools and Models](#)



[Support](#)

Click [here](#) to ask an associate for production status of specific part numbers.

## Reinforced, Fast, Low-Power, Four-Channel Digital Isolators

## MAX22444–MAX22446

### General Description

The MAX22444–MAX22446 are reinforced, fast, low-power 4-channel digital galvanic isolators using Maxim's proprietary process technology. These devices transfer digital signals between circuits with different power domains, using as little as 0.74mW per channel at 1Mbps (1.8V supply). All of the devices in the family feature reinforced isolation for a withstand voltage rating of 5kV<sub>RMS</sub> for 60 seconds.

The MAX22444–MAX22446 family offers all possible unidirectional channel configurations to accommodate any 4-channel design, including SPI, RS-485, and digital I/O applications. Output enable for the A side of the MAX22445R/S/U/V is active-low, making them ideal for isolating a port on a shared SPI bus since the  $\overline{CS}$  signal can directly enable the MISO signal on the isolator. All other output enables in the MAX22444-MAX22446 family are the traditional active-high.

All channels on the MAX22444–MAX22446M/N are always enabled, however, the default state of the outputs of these devices is selectable.

Devices are available with a maximum data rate of either 25Mbps or 200Mbps, and with outputs that are either default-high or default-low. The default is the state the output assumes when the input is either not powered or is open-circuit. See the [Ordering Information](#) and [Product Selector Guide](#) for suffixes associated with each option. Independent 1.71V to 5.5V supplies on each side of the isolator also make the devices suitable for use as level translators.

All of the devices in the MAX22444–MAX22446 family are available in a 16-pin wide-body SOIC package with 8mm of creepage and clearance. The package material has a minimum comparative tracking index (CTI) of 400, which gives it a group II rating in creepage tables. All devices are rated for operation at ambient temperatures of -40°C to +125°C.

### Benefits and Features

- Reinforced Galvanic Isolation for Fast Digital Signals
  - Up to 200Mbps Maximum Data Rate
  - Withstands 5kV<sub>RMS</sub> for 60s ( $V_{ISO}$ )
  - Continuously Withstands 1500V<sub>RMS</sub> ( $V_{IOWM}$ )
  - Withstands  $\pm 12.8$ kV Surge Between GNDA and GNDB with 1.2/50 $\mu$ s waveform
  - High CMTI (50kV/ $\mu$ s, Typical)
- Low Power Consumption
  - 0.74mW per Channel at 1Mbps with  $V_{DD} = 1.8$ V
  - 1.4mW per Channel at 1Mbps with  $V_{DD} = 3.3$ V
  - 3.2mW per Channel at 100Mbps with  $V_{DD} = 1.8$ V
- Options to Support a Broad Range of Applications
  - 2 Maximum Data Rates (200Mbps, 25Mbps)
  - 3 Direction Configurations
  - Active-High or Active-Low Enable Inputs
  - 2 Fixed Output Default States (High/Low) or Pin-Selectable (M/N Versions)

### Applications

- Isolated SPI Interface
- Fieldbus Communications for Industrial Automation
- Isolated RS-485/RS-422, CAN
- Battery Management
- Medical Systems

### Safety Regulatory Approvals

- UL According to UL1577
- cUL According to CSA Bulletin 5A
- VDE 0884-11 Reinforced Isolation

[Ordering Information](#) and [Product Selector Guide](#) appear at end of data sheet.

### Absolute Maximum Ratings

V <sub>DDA</sub> to GNDA.....	-0.3V to +6V
V <sub>DDB</sub> to GNDB.....	-0.3V to +6V
IN_ on Side A, ENA, $\overline{\text{ENA}}$ , DEFA to GNDA.....	-0.3V to +6V
IN_ on Side B, ENB, DEFB to GNDB.....	-0.3V to +6V
OUT_ on Side A to GNDA.....	-0.3V to (V <sub>DDA</sub> + 0.3V)
OUT_ on Side B to GNDB.....	-0.3V to (V <sub>DDB</sub> + 0.3V)
Short-Circuit Continuous Current	
OUT_ on Side A to GNDA,	
OUT_ on Side B to GNDB.....	±30mA

Continuous Power Dissipation (T <sub>A</sub> = +70°C)	
Wide SOIC (derate 14.1mW/°C above +70°C).....	1126.8mW
Operating Temperature Range.....	-40°C to +125°C
Maximum Junction Temperature.....	+150°C
Storage Temperature Range.....	-60°C to +150°C
Lead Temperature (soldering, 10s).....	+300°C
Soldering Temperature (reflow).....	+260°C

Stresses beyond those listed under "Absolute Maximum Ratings" may cause permanent damage to the device. These are stress ratings only; functional operation of the device at these or any other conditions beyond those indicated in the operational sections of the specifications is not implied. Exposure to absolute maximum rating conditions for extended periods may affect device reliability.

### Package Information

<b>PACKAGE TYPE: 16 Wide SOIC</b>	
Package Code	W16MS+12
Outline Number	<a href="#">21-0042</a>
Land Pattern Number	<a href="#">90-0107</a>
<b>THERMAL RESISTANCE, FOUR-LAYER BOARD</b>	
Junction to Ambient (θ <sub>JA</sub> )	71°C/W
Junction to Case (θ <sub>JC</sub> )	24°C/W

Package thermal resistances were obtained using the method described in JEDEC specification JESD51-7, using a four-layer board. For detailed information on package thermal considerations, refer to [www.maximintegrated.com/thermal-tutorial](http://www.maximintegrated.com/thermal-tutorial).

For the latest package outline information and land patterns (footprints), go to [www.maximintegrated.com/packages](http://www.maximintegrated.com/packages). Note that a "+", "#", or "-" in the package code indicates RoHS status only. Package drawings may show a different suffix character, but the drawing pertains to the package regardless of RoHS status.

### DC Electrical Characteristics

(V<sub>DDA</sub> - V<sub>GNDA</sub> = 1.71V to 5.5V, V<sub>DDB</sub> - V<sub>GNDB</sub> = 1.71V to 5.5V, C<sub>L</sub> = 15pF, T<sub>A</sub> = -40°C to +125°C, unless otherwise noted. Typical values are at V<sub>DDA</sub> - V<sub>GNDA</sub> = 3.3V, V<sub>DDB</sub> - V<sub>GNDB</sub> = 3.3V, V<sub>GNDA</sub> = V<sub>GNDB</sub>, T<sub>A</sub> = +25°C, unless otherwise noted.) (Notes 1, 3)

PARAMETER	SYMBOL	CONDITIONS	MIN	TYP	MAX	UNITS
<b>POWER SUPPLY</b>						
Supply Voltage	V <sub>DDA</sub>	Relative to GNDA	1.71		5.5	V
	V <sub>DDB</sub>	Relative to GNDB	1.71		5.5	
Undervoltage-Lockout Threshold	V <sub>UVLO_</sub>	V <sub>DD_</sub> rising	1.5	1.6	1.66	V
Undervoltage-Lockout Threshold Hysteresis	V <sub>UVLO_HYST</sub>			45		mV

DC Electrical Characteristics (continued)

( $V_{DDA} - V_{GNDA} = 1.71V$  to  $5.5V$ ,  $V_{DDB} - V_{GNDB} = 1.71V$  to  $5.5V$ ,  $C_L = 15pF$ ,  $T_A = -40^{\circ}C$  to  $+125^{\circ}C$ , unless otherwise noted. Typical values are at  $V_{DDA} - V_{GNDA} = 3.3V$ ,  $V_{DDB} - V_{GNDB} = 3.3V$ ,  $V_{GNDA} = V_{GNDB}$ ,  $T_A = +25^{\circ}C$ , unless otherwise noted.) (Notes 1, 3)

PARAMETER	SYMBOL	CONDITIONS		MIN	TYP	MAX	UNITS
Side A Supply Current (MAX22444_) (Note 2)	$I_{DDA}$	500kHz square wave, $C_L = 0pF$	$V_{DDA} = 5V$	0.54	1.00	mA	
			$V_{DDA} = 3.3V$	0.53	0.97		
			$V_{DDA} = 2.5V$	0.52	0.96		
			$V_{DDA} = 1.8V$	0.50	0.68		
		12.5MHz square wave, $C_L = 0pF$	$V_{DDA} = 5V$	1.67	2.50		
			$V_{DDA} = 3.3V$	1.64	2.43		
			$V_{DDA} = 2.5V$	1.62	2.41		
			$V_{DDA} = 1.8V$	1.58	2.07		
		50MHz square wave, $C_L = 0pF$	$V_{DDA} = 5V$	4.63	6.31		
			$V_{DDA} = 3.3V$	4.53	6.17		
			$V_{DDA} = 2.5V$	4.48	6.11		
			$V_{DDA} = 1.8V$	4.34	5.60		
Side B Supply Current (MAX22444_) (Note 2)	$I_{DDB}$	500kHz square wave, $C_L = 0pF$	$V_{DDB} = 5V$	1.19	2.06	mA	
			$V_{DDB} = 3.3V$	1.17	2.02		
			$V_{DDB} = 2.5V$	1.17	2.01		
			$V_{DDB} = 1.8V$	1.14	1.92		
		12.5MHz square wave, $C_L = 0pF$	$V_{DDB} = 5V$	2.28	3.29		
			$V_{DDB} = 3.3V$	1.85	2.79		
			$V_{DDB} = 2.5V$	1.68	2.58		
			$V_{DDB} = 1.8V$	1.51	2.33		
		50MHz square wave, $C_L = 0pF$	$V_{DDB} = 5V$	5.66	7.07		
			$V_{DDB} = 3.3V$	3.98	5.16		
			$V_{DDB} = 2.5V$	3.28	4.34		
			$V_{DDB} = 1.8V$	2.69	3.59		
Side A Supply Current (MAX22445_) (Note 2)	$I_{DDA}$	500kHz square wave, $C_L = 0pF$	$V_{DDA} = 5V$	0.70	1.26	mA	
			$V_{DDA} = 3.3V$	0.69	1.23		
			$V_{DDA} = 2.5V$	0.68	1.22		
			$V_{DDA} = 1.8V$	0.66	0.99		
		12.5MHz square wave, $C_L = 0pF$	$V_{DDA} = 5V$	1.83	2.70		
			$V_{DDA} = 3.3V$	1.70	2.53		
			$V_{DDA} = 2.5V$	1.63	2.45		
			$V_{DDA} = 1.8V$	1.56	2.14		
		50MHz square wave, $C_L = 0pF$	$V_{DDA} = 5V$	4.89	6.51		
			$V_{DDA} = 3.3V$	4.39	5.93		
			$V_{DDA} = 2.5V$	4.18	5.67		
			$V_{DDA} = 1.8V$	3.93	5.11		

DC Electrical Characteristics (continued)

( $V_{DDA} - V_{GNDA} = 1.71V$  to  $5.5V$ ,  $V_{DDB} - V_{GNDB} = 1.71V$  to  $5.5V$ ,  $C_L = 15pF$ ,  $T_A = -40^{\circ}C$  to  $+125^{\circ}C$ , unless otherwise noted. Typical values are at  $V_{DDA} - V_{GNDA} = 3.3V$ ,  $V_{DDB} - V_{GNDB} = 3.3V$ ,  $V_{GNDA} = V_{GNDB}$ ,  $T_A = +25^{\circ}C$ , unless otherwise noted.) (Notes 1, 3)

PARAMETER	SYMBOL	CONDITIONS		MIN	TYP	MAX	UNITS
Side B Supply Current (MAX22445_) (Note 2)	$I_{DDB}$	500kHz square wave, $C_L = 0pF$	$V_{DDB} = 5V$	1.03	1.80	mA	
			$V_{DDB} = 3.3V$	1.01	1.76		
			$V_{DDB} = 2.5V$	1.01	1.75		
			$V_{DDB} = 1.8V$	0.98	1.61		
		12.5MHz square wave, $C_L = 0pF$	$V_{DDB} = 5V$	2.13	3.09		
			$V_{DDB} = 3.3V$	1.80	2.70		
			$V_{DDB} = 2.5V$	1.66	2.54		
			$V_{DDB} = 1.8V$	1.53	2.27		
		50MHz square wave, $C_L = 0pF$	$V_{DDB} = 5V$	5.41	6.88		
			$V_{DDB} = 3.3V$	4.11	5.41		
			$V_{DDB} = 2.5V$	3.58	4.78		
			$V_{DDB} = 1.8V$	3.11	4.11		
Side A Supply Current (MAX22446_) (Note 2)	$I_{DDA}$	500kHz square wave, $C_L = 0pF$	$V_{DDA} = 5V$	0.87	1.53	mA	
			$V_{DDA} = 3.3V$	0.85	1.49		
			$V_{DDA} = 2.5V$	0.84	1.49		
			$V_{DDA} = 1.8V$	0.82	1.30		
		12.5MHz square wave, $C_L = 0pF$	$V_{DDA} = 5V$	1.98	2.89		
			$V_{DDA} = 3.3V$	1.75	2.61		
			$V_{DDA} = 2.5V$	1.65	2.49		
			$V_{DDA} = 1.8V$	1.55	2.20		
		50MHz square wave, $C_L = 0pF$	$V_{DDA} = 5V$	5.15	6.69		
			$V_{DDA} = 3.3V$	4.25	5.66		
			$V_{DDA} = 2.5V$	3.88	5.22		
			$V_{DDA} = 1.8V$	3.52	4.60		
Side B Supply Current (MAX22446_) (Note 2)	$I_{DDB}$	500kHz square wave, $C_L = 0pF$	$V_{DDB} = 5V$	0.87	1.53	mA	
			$V_{DDB} = 3.3V$	0.85	1.49		
			$V_{DDB} = 2.5V$	0.84	1.49		
			$V_{DDB} = 1.8V$	0.82	1.30		
		12.5MHz square wave, $C_L = 0pF$	$V_{DDB} = 5V$	1.98	2.89		
			$V_{DDB} = 3.3V$	1.75	2.61		
			$V_{DDB} = 2.5V$	1.65	2.49		
			$V_{DDB} = 1.8V$	1.55	2.20		
		50MHz square wave, $C_L = 0pF$	$V_{DDB} = 5V$	5.15	6.69		
			$V_{DDB} = 3.3V$	4.25	5.66		
			$V_{DDB} = 2.5V$	3.88	5.22		
			$V_{DDB} = 1.8V$	3.52	4.60		

DC Electrical Characteristics (continued)

( $V_{DDA} - V_{GNDA} = 1.71V$  to  $5.5V$ ,  $V_{DDB} - V_{GNDB} = 1.71V$  to  $5.5V$ ,  $C_L = 15pF$ ,  $T_A = -40^{\circ}C$  to  $+125^{\circ}C$ , unless otherwise noted. Typical values are at  $V_{DDA} - V_{GNDA} = 3.3V$ ,  $V_{DDB} - V_{GNDB} = 3.3V$ ,  $V_{GNDA} = V_{GNDB}$ ,  $T_A = +25^{\circ}C$ , unless otherwise noted.) (Notes 1, 3)

PARAMETER	SYMBOL	CONDITIONS	MIN	TYP	MAX	UNITS
<b>LOGIC INTERFACE (IN_, EN_, ENA, DEF_, OUT_)</b>						
Input High Voltage	$V_{IH}$	EN_, ENA, IN_	$2.25V \leq V_{DD\_} \leq 5.5V$	0.7 x $V_{DD\_}$		V
			$1.71V \leq V_{DD\_} < 2.25V$	0.75 x $V_{DD\_}$		
		DEF_ (Note 2)	$2.25V \leq V_{DD\_} \leq 5.5V$	0.7 x $V_{DD\_}$		
			$1.71V \leq V_{DD\_} < 2.25V$	0.75 x $V_{DD\_}$		
Input Low Voltage	$V_{IL}$	EN_, ENA, IN_	$2.25V \leq V_{DD\_} \leq 5.5V$	0.8		V
			$1.71V \leq V_{DD\_} < 2.25V$	0.7		
		DEF_ (Note 2)	$2.25V \leq V_{DD\_} \leq 5.5V$	0.8		
			$1.71V \leq V_{DD\_} < 2.25V$	0.7		
Input Hysteresis	$V_{HYS}$	EN_, ENA, DEF_, IN_	MAX2244_B/E/M/R/U	410		mV
			MAX2244_C/F/N/S/V	80		
IN_ Input Pullup Current	$I_{PU}$	MAX2244_B/C/R/S	-10	-5	-1.5	$\mu A$
		MAX2244_M/N, DEFA = DEF B = high	-10	-5	-1.5	
IN_ Input Pulldown Current	$I_{PD}$	MAX2244_E/F/U/V	1.5	5	10	$\mu A$
		MAX2244_M/N, DEFA = DEF B = low	1.5	5	10	
IN_ Input Capacitance	$C_{IN}$	$f_{SW} = 1MHz$		2		pF
ENA Pullup Current	$I_{PU\_ENA}$	MAX2244_B/C/E/F	-10	-5	-1.5	$\mu A$
ENB Pullup Current	$I_{PU\_ENB}$	MAX2244_B/C/E/F/R/S/U/V	-10	-5	-1.5	$\mu A$
EN A Pulldown Current	$I_{PD\_EN}$	MAX22445R/S/U/V	1.5	5	10	$\mu A$
DEF_ Pullup Current	$I_{PU\_DEF}$	MAX2244_M/N	-10	-5	-1.5	$\mu A$
OUT_ Output Voltage High	$V_{OH}$	$I_{OUT\_} = -4mA$ source	$V_{DD\_}$ - 0.4			V
OUT_ Output Voltage Low	$V_{OL}$	$I_{OUT\_} = 4mA$ sink			0.4	V

**Dynamic Characteristics MAX2244\_C/F/N/S/V**

( $V_{DDA} - V_{GNDA} = 1.71V$  to  $5.5V$ ,  $V_{DDB} - V_{GNDB} = 1.71V$  to  $5.5V$ ,  $C_L = 15pF$ ,  $T_A = -40^{\circ}C$  to  $+125^{\circ}C$ , unless otherwise noted. Typical values are at  $V_{DDA} - V_{GNDA} = 3.3V$ ,  $V_{DDB} - V_{GNDB} = 3.3V$ ,  $V_{GNDA} = V_{GNDB}$ ,  $T_A = +25^{\circ}C$ , unless otherwise noted.) (Notes 2, 4)

PARAMETER	SYMBOL	CONDITIONS		MIN	TYP	MAX	UNITS
Common-Mode Transient Immunity	CMTI	IN_ = GND_ or VDD_ (Note 5)		50			kV/ $\mu$ s
Maximum Data Rate	DR <sub>MAX</sub>	$2.25V \leq V_{DD\_} \leq 5.5V$		200			Mbps
		$1.71V \leq V_{DD\_} < 2.25V$		150			
Minimum Pulse Width	PW <sub>MIN</sub>	IN_ to OUT_	$2.25V \leq V_{DD\_} \leq 5.5V$	5.00			ns
			$1.71V \leq V_{DD\_} < 2.25V$	6.67			
Propagation Delay (Figure 3)	t <sub>PLH</sub>	IN_ to OUT_, C <sub>L</sub> = 15pF	$4.5V \leq V_{DD\_} \leq 5.5V$	4.1	5.7	9.2	ns
			$3.0V \leq V_{DD\_} \leq 3.6V$	4.2	6.5	10.2	
			$2.25V \leq V_{DD\_} \leq 2.75V$	4.9	7.9	13.4	
			$1.71V \leq V_{DD\_} \leq 1.89V$	7.1	12.0	20.3	
	t <sub>PHL</sub>	IN_ to OUT_, C <sub>L</sub> = 15pF	$4.5V \leq V_{DD\_} \leq 5.5V$	4.3	6.1	9.4	
			$3.0V \leq V_{DD\_} \leq 3.6V$	4.4	6.9	10.5	
			$2.25V \leq V_{DD\_} \leq 2.75V$	5.1	8.2	14.1	
			$1.71V \leq V_{DD\_} \leq 1.89V$	7.2	12.1	21.7	
Pulse Width Distortion	PWD	t <sub>PLH</sub> - t <sub>PHL</sub>	$4.5V \leq V_{DD\_} \leq 5.5V$	0.4		2.0	ns
			$3.0V \leq V_{DD\_} \leq 3.6V$	0.4		2.0	
			$2.25V \leq V_{DD\_} \leq 2.75V$	0.3		2.0	
			$1.71V \leq V_{DD\_} \leq 1.89V$	0.0		2.0	
Propagation Delay Skew Part-to-Part (Same Channel)	t <sub>SPLH</sub>		$4.5V \leq V_{DD\_} \leq 5.5V$	3.7			ns
			$3.0V \leq V_{DD\_} \leq 3.6V$	4.3			
			$2.25V \leq V_{DD\_} \leq 2.75V$	6.0			
			$1.71V \leq V_{DD\_} \leq 1.89V$	10.3			
	t <sub>SPLH</sub>		$4.5V \leq V_{DD\_} \leq 5.5V$	3.8			
			$3.0V \leq V_{DD\_} \leq 3.6V$	4.7			
			$2.25V \leq V_{DD\_} \leq 2.75V$	6.5			
			$1.71V \leq V_{DD\_} \leq 1.89V$	11.5			
Propagation Delay Skew Channel-to-Channel (Same Direction)	t <sub>SCSLH</sub>	$1.71V \leq V_{DD\_} \leq 5.5V$	2.0			ns	
	t <sub>SCSHL</sub>	$1.71V \leq V_{DD\_} \leq 5.5V$	2.0				

**Dynamic Characteristics MAX2244\_C/F/N/S/V (continued)**

( $V_{DDA} - V_{GNDA} = 1.71V$  to  $5.5V$ ,  $V_{DDB} - V_{GNDB} = 1.71V$  to  $5.5V$ ,  $C_L = 15pF$ ,  $T_A = -40^{\circ}C$  to  $+125^{\circ}C$ , unless otherwise noted. Typical values are at  $V_{DDA} - V_{GNDA} = 3.3V$ ,  $V_{DDB} - V_{GNDB} = 3.3V$ ,  $V_{GNDA} = V_{GNDB}$ ,  $T_A = +25^{\circ}C$ , unless otherwise noted.) (Notes 2, 4)

PARAMETER	SYMBOL	CONDITIONS		MIN	TYP	MAX	UNITS
Propagation Delay Skew Channel-to-Channel (Opposite Direction)	t <sub>SCOLH</sub>	4.5V ≤ V <sub>DD_</sub> ≤ 5.5V				2.9	ns
		3.0V ≤ V <sub>DD_</sub> ≤ 3.6V				3.4	
		2.25V ≤ V <sub>DD_</sub> ≤ 2.75V				4.9	
		1.71V ≤ V <sub>DD_</sub> ≤ 1.89V				10.2	
	t <sub>SCOHL</sub>	4.5V ≤ V <sub>DD_</sub> ≤ 5.5V				3.2	
		3.0V ≤ V <sub>DD_</sub> ≤ 3.6V				3.8	
		2.25V ≤ V <sub>DD_</sub> ≤ 2.75V				5.3	
		1.71V ≤ V <sub>DD_</sub> ≤ 1.89V				10.9	
Peak Eye Diagram Jitter	T <sub>JIT(PK)</sub>	200Mbps			100		ps
Clock Jitter RMS	T <sub>JCLK(RMS)</sub>	500kHz clock input, rising/falling edges			7.5		ps
Rise Time (Figure 3)	t <sub>R</sub>	C <sub>L</sub> = 5pF	4.5V ≤ V <sub>DD_</sub> ≤ 5.5V			0.8	ns
			3.0V ≤ V <sub>DD_</sub> ≤ 3.6V			1.1	
			2.25V ≤ V <sub>DD_</sub> ≤ 2.75V			1.5	
			1.71V ≤ V <sub>DD_</sub> ≤ 1.89V			2.4	
Fall Time (Figure 3)	t <sub>F</sub>	C <sub>L</sub> = 5pF	4.5V ≤ V <sub>DD_</sub> ≤ 5.5V			1.0	ns
			3.0V ≤ V <sub>DD_</sub> ≤ 3.6V			1.4	
			2.25V ≤ V <sub>DD_</sub> ≤ 2.75V			1.9	
			1.71V ≤ V <sub>DD_</sub> ≤ 1.89V			3.0	
Enable to Data Valid (MAX2244_C/F/S/V only, Figure 4)	t <sub>EN</sub>	EN <sub>_</sub> to OUT <sub>_</sub> , C <sub>L</sub> = 15pF	4.5V ≤ V <sub>DD_</sub> ≤ 5.5V			3.9	ns
			3.0V ≤ V <sub>DD_</sub> ≤ 3.6V			6.4	
			2.25V ≤ V <sub>DD_</sub> ≤ 2.75V			10.1	
			1.71V ≤ V <sub>DD_</sub> ≤ 1.89V			18.4	
Enable to Tristate (MAX2244_C/F/S/V only, Figure 4)	t <sub>TRI</sub>	EN <sub>_</sub> to OUT <sub>_</sub> , C <sub>L</sub> = 15pF	4.5V ≤ V <sub>DD_</sub> ≤ 5.5V			6.3	ns
			3.0V ≤ V <sub>DD_</sub> ≤ 3.6V			9.0	
			2.25V ≤ V <sub>DD_</sub> ≤ 2.75V			12.6	
			1.71V ≤ V <sub>DD_</sub> ≤ 1.89V			19.2	

Dynamic Characteristics MAX2244\_B/E/M/R/U

( $V_{DDA} - V_{GNDA} = 1.71V$  to  $5.5V$ ,  $V_{DDB} - V_{GNDB} = 1.71V$  to  $5.5V$ ,  $C_L = 15pF$ ,  $T_A = -40^{\circ}C$  to  $+125^{\circ}C$ , unless otherwise noted. Typical values are at  $V_{DDA} - V_{GNDA} = 3.3V$ ,  $V_{DDB} - V_{GNDB} = 3.3V$ ,  $V_{GNDA} = V_{GNDB}$ ,  $T_A = +25^{\circ}C$ , unless otherwise noted.) (Notes 2, 4)

PARAMETER	SYMBOL	CONDITIONS	MIN	TYP	MAX	UNITS	
Common-Mode Transient Immunity	CMTI	IN_ = GND_ or VDD_ (Note 5)		50		kV/ $\mu$ s	
Maximum Data Rate	DR <sub>MAX</sub>		25			Mbps	
Minimum Pulse Width	PW <sub>MIN</sub>	IN_ to OUT_			40	ns	
Glitch Rejection		IN_ to OUT_	10	17	29	ns	
Propagation Delay (Figure 3)	t <sub>PLH</sub>	IN_ to OUT_, C <sub>L</sub> = 15pF	4.5V ≤ V <sub>DD_</sub> ≤ 5.5V	17.4	24.2	32.5	ns
			3.0V ≤ V <sub>DD_</sub> ≤ 3.6V	17.6	25.0	33.7	
			2.25V ≤ V <sub>DD_</sub> ≤ 2.75V	18.3	26.4	36.7	
			1.71V ≤ V <sub>DD_</sub> ≤ 1.89V	20.7	30.6	43.5	
	t <sub>PHL</sub>	IN_ to OUT_, C <sub>L</sub> = 15pF	4.5V ≤ V <sub>DD_</sub> ≤ 5.5V	16.9	24.0	33.6	
			3.0V ≤ V <sub>DD_</sub> ≤ 3.6V	17.2	24.8	35.1	
			2.25V ≤ V <sub>DD_</sub> ≤ 2.75V	17.8	26.1	38.2	
			1.71V ≤ V <sub>DD_</sub> ≤ 1.89V	19.8	30.0	45.8	
Pulse Width Distortion	PWD	t <sub>PLH</sub> - t <sub>PHL</sub>	4.5V ≤ V <sub>DD_</sub> ≤ 5.5V		0.2	4.0	ns
			3.0V ≤ V <sub>DD_</sub> ≤ 3.6V		0.2	4.0	
			2.25V ≤ V <sub>DD_</sub> ≤ 2.75V		0.3	4.0	
			1.71V ≤ V <sub>DD_</sub> ≤ 1.89V		0.6	4.0	
Propagation Delay Skew Part-to-Part (Same Channel)	t <sub>SPLH</sub>		4.5V ≤ V <sub>DD_</sub> ≤ 5.5V			15.1	ns
			3.0V ≤ V <sub>DD_</sub> ≤ 3.6V			15.0	
			2.25V ≤ V <sub>DD_</sub> ≤ 2.75V			15.4	
			1.71V ≤ V <sub>DD_</sub> ≤ 1.89V			20.5	
	t <sub>SPHL</sub>		4.5V ≤ V <sub>DD_</sub> ≤ 5.5V			13.9	
			3.0V ≤ V <sub>DD_</sub> ≤ 3.6V			14.2	
			2.25V ≤ V <sub>DD_</sub> ≤ 2.75V			16.0	
			1.71V ≤ V <sub>DD_</sub> ≤ 1.89V			21.8	
Propagation Delay Skew Channel-to-Channel (Same Direction)	t <sub>SCSLH</sub>	1.71V ≤ V <sub>DD_</sub> ≤ 5.5V			2.0	ns	
	t <sub>SCSHL</sub>	1.71V ≤ V <sub>DD_</sub> ≤ 5.5V			2.0		
Propagation Delay Skew Channel-to-Channel (Opposite Direction)	t <sub>SCOLH</sub>		4.5V ≤ V <sub>DD_</sub> ≤ 5.5V			13.9	ns
			3.0V ≤ V <sub>DD_</sub> ≤ 3.6V			13.7	
			2.25V ≤ V <sub>DD_</sub> ≤ 2.75V			14.2	
			1.71V ≤ V <sub>DD_</sub> ≤ 1.89V			19.4	
	t <sub>SCOHL</sub>		4.5V ≤ V <sub>DD_</sub> ≤ 5.5V			13.0	
			3.0V ≤ V <sub>DD_</sub> ≤ 3.6V			12.9	
			2.25V ≤ V <sub>DD_</sub> ≤ 2.75V			14.4	
			1.71V ≤ V <sub>DD_</sub> ≤ 1.89V			20.1	



**Dynamic Characteristics MAX2244\_B/E/M/R/U (continued)**

( $V_{DDA} - V_{GNDA} = 1.71V$  to  $5.5V$ ,  $V_{DDB} - V_{GNDB} = 1.71V$  to  $5.5V$ ,  $C_L = 15pF$ ,  $T_A = -40^{\circ}C$  to  $+125^{\circ}C$ , unless otherwise noted. Typical values are at  $V_{DDA} - V_{GNDA} = 3.3V$ ,  $V_{DDB} - V_{GNDB} = 3.3V$ ,  $V_{GNDA} = V_{GNDB}$ ,  $T_A = +25^{\circ}C$ , unless otherwise noted.) (Notes 2, 4)

PARAMETER	SYMBOL	CONDITIONS		MIN	TYP	MAX	UNITS
Peak Eye Diagram Jitter	$T_{JIT(PK)}$	25Mbps			250		ps
Rise Time (Figure 3)	$t_R$	$C_L = 5pF$	$4.5V \leq V_{DD\_} \leq 5.5V$			0.8	ns
			$3.0V \leq V_{DD\_} \leq 3.6V$			1.1	
			$2.25V \leq V_{DD\_} \leq 2.75V$			1.5	
			$1.71V \leq V_{DD\_} \leq 1.89V$			2.4	
Fall Time (Figure 3)	$t_F$	$C_L = 5pF$	$4.5V \leq V_{DD\_} \leq 5.5V$			1.0	ns
			$3.0V \leq V_{DD\_} \leq 3.6V$			1.4	
			$2.25V \leq V_{DD\_} \leq 2.75V$			1.9	
			$1.71V \leq V_{DD\_} \leq 1.89V$			3.0	
Enable to Data Valid (MAX2244_B/E/R/U only, Figure 4)	$t_{EN}$	$\overline{ENA}$ to OUT_, EN_ to OUT_, $C_L = 15pF$	$4.5V \leq V_{DD\_} \leq 5.5V$			3.9	ns
			$3.0V \leq V_{DD\_} \leq 3.6V$			6.4	
			$2.25V \leq V_{DD\_} \leq 2.75V$			10.1	
			$1.71V \leq V_{DD\_} \leq 1.89V$			18.4	
Enable to Tristate (MAX2244_B/E/R/U only, Figure 4)	$t_{TRI}$	$\overline{ENA}$ to OUT_, EN_ to OUT_, $C_L = 15pF$	$4.5V \leq V_{DD\_} \leq 5.5V$			6.3	ns
			$3.0V \leq V_{DD\_} \leq 3.6V$			9.0	
			$2.25V \leq V_{DD\_} \leq 2.75V$			12.6	
			$1.71V \leq V_{DD\_} \leq 1.89V$			19.2	

**Note 1:** All devices are 100% production tested at  $T_A = +125^{\circ}C$ . Specifications over temperature are guaranteed by design and characterization.

**Note 2:** Not production tested. Guaranteed by design and characterization.

**Note 3:** All currents into the device are positive. All currents out of the device are negative. All voltages are referenced to their respective ground (GNDA or GNDB), unless otherwise noted.

**Note 4:** All measurements taken with  $V_{DDA} = V_{DDB}$ , unless otherwise noted.

**Note 5:** CMTI is the maximum sustainable common-mode voltage slew rate while maintaining the correct output. CMTI applies to both rising and falling common-mode voltage edges. Tested with the transient generator connected between GNDA and GNDB ( $V_{CM} = 1000V$ ).

**ESD Protection**

PARAMETER	SYMBOL	CONDITIONS	MIN	TYP	MAX	UNITS
ESD		Human Body Model, All Pins		$\pm 4$		kV

**Table 1. Insulation Characteristics**

PARAMETER	SYMBOL	CONDITIONS	VALUE	UNITS
Partial Discharge Test Voltage	$V_{PR}$	Method B1 = $V_{IORM} \times 1.875$ ( $t = 1s$ , partial discharge < 5pC)	3977	$V_P$
Maximum Repetitive Peak Isolation Voltage	$V_{IORM}$	(Note 6)	2121	$V_P$
Maximum Working Isolation Voltage	$V_{IOWM}$	Continuous RMS voltage (Note 6)	1500	$V_{RMS}$
Maximum Transient Isolation Voltage	$V_{IOTM}$	$t = 1s$ (Note 6)	8000	$V_P$
Maximum Withstand Isolation Voltage	$V_{ISO}$	$f_{SW} = 60Hz$ , duration = 60s (Notes 6, 7)	5000	$V_{RMS}$
Maximum Surge Isolation Voltage	$V_{IOSM}$	Reinforced Insulation, test method per IEC 60065, $V_{TEST} = 1.6 \times V_{IOSM} = 12800V_{PEAK}$ (Notes 6, 9)	8000	$V_P$
Insulation Resistance	$R_{IO}$	$V_{IO} = 500V$ , $T_A = 25^\circ C$	$>10^{12}$	$\Omega$
		$V_{IO} = 500V$ , $100^\circ C \leq T_A \leq 125^\circ C$	$>10^{11}$	
		$V_{IO} = 500V$ at $T_S = 150^\circ C$	$>10^9$	
Barrier Capacitance Side A to Side B	$C_{IO}$	$f_{SW} = 1MHz$ (Note 8)	1.5	pF
Minimum Creepage Distance	CPG		8	mm
Minimum Clearance Distance	CLR		8	mm
Internal Clearance		Distance through insulation	0.021	mm
Comparative Tracking Index	CTI	Material Group II (IEC 60112)	>400	
Climate Category			40/125/21	
Pollution Degree (DIN VDE 0110, Table 1)			2	

**Note 6:**  $V_{ISO}$ ,  $V_{IOTM}$ ,  $V_{IOSM}$ ,  $V_{IOWM}$ , and  $V_{IORM}$  are defined by the IEC 60747-5-5 standard.

**Note 7:** Product is qualified at  $V_{ISO}$  for 60s and 100% production tested at 120% of  $V_{ISO}$  for 1s.

**Note 8:** Capacitance is measured with all pins on field-side and logic-side tied together.

**Note 9:** Devices are submerged in oil during surge characterization.

### Safety Regulatory Approvals

<b>UL</b>
The MAX22444–MAX22446 are certified under UL1577. For more details, refer to File E351759.
Rated up to 5000V <sub>RMS</sub> isolation voltage for single protection.
<b>cUL (Equivalent to CSA notice 5A)</b>
The MAX22444–MAX22446 are certified up to 5000V <sub>RMS</sub> for single protection. For more details, refer to File E351759.
<b>VDE</b>
The MAX22444–MAX22446 are certified to DIN VDE V 0884-11: 2017-1. For details, see file reference 5015017-4880-0002/279085/TL7/SCT; Certificate Number 40049143. Reinforced Insulation, Maximum Transient Isolation Voltage 8000V <sub>PK</sub> , Maximum Repetitive Peak Isolation Voltage 2121V <sub>PK</sub>

*These couplers are suitable for “safe electrical insulation” only within the safety ratings. Compliance with the safety ratings shall be ensured by means of suitable protective circuits.*

**Safety Limits**

Damage to the IC can result in a low-resistance path to ground or to the supply and, without current limiting, the MAX22444-MAX22446 could dissipate excessive amounts of power. Excessive power dissipation can damage the die and result in damage to the isolation barrier, potentially causing downstream issues. [Table 2](#) shows the safety limits for the MAX22444-MAX22446.

The maximum safety temperature ( $T_S$ ) for the device is the 150°C maximum junction temperature specified in the Absolute Maximum Ratings. The power dissipation ( $P_D$ ) and junction-to-ambient thermal impedance ( $\theta_{JA}$ ) deter-

mine the junction temperature. Thermal impedance values ( $\theta_{JA}$  and  $\theta_{JC}$ ) are available in the Package Thermal Characteristics section of the datasheet and power dissipation calculations are discussed in the Calculating Power Dissipation section. Calculate the junction temperature ( $T_J$ ) as:

$$T_J = T_A + (P_D \times \theta_{JA})$$

[Figure 1](#) and [Figure 2](#) show the thermal derating curve for safety limiting the power and the current of the device. Ensure that the junction temperature does not exceed 150°C.

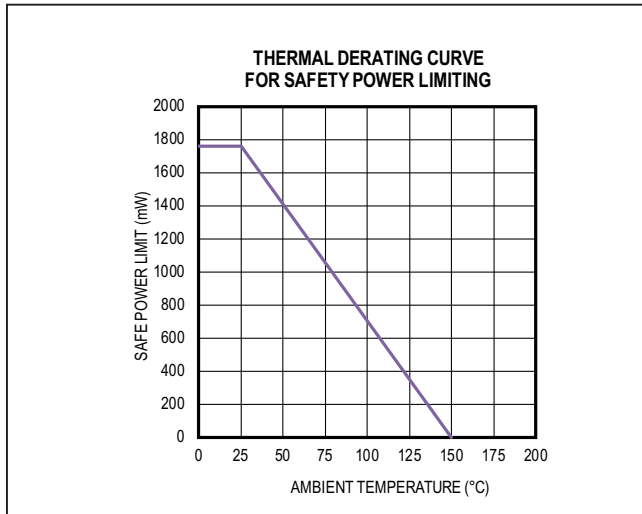

Figure 1. Thermal Derating Curve for Safety Power Limiting

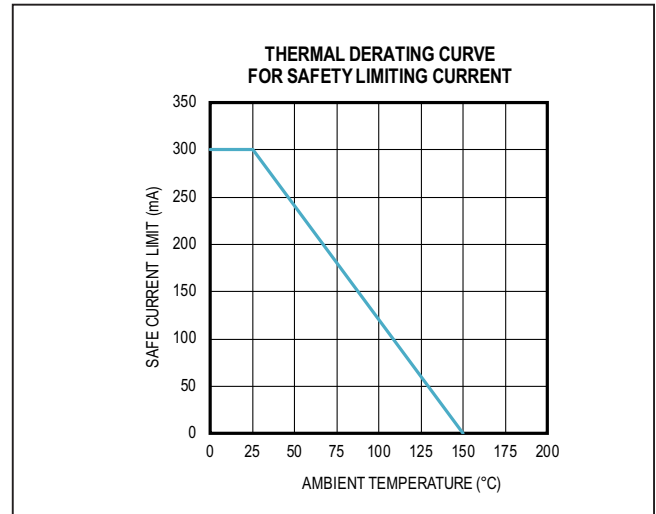

Figure 2. Thermal Derating Curve for Safety Current Limiting

**Table 2. Safety Limiting Values for the MAX22444-MAX22446**

PARAMETER	SYMBOL	TEST CONDITIONS	MAX	UNIT
Safety Current on Any Pin (No Damage to Isolation Barrier)	$I_S$	$T_J = 150^\circ\text{C}, T_A = 25^\circ\text{C}$	300	mA
Total Safety Power Dissipation	$P_S$	$T_J = 150^\circ\text{C}, T_A = 25^\circ\text{C}$	1760	mW
Maximum Safety Temperature	$T_S$		150	°C

Test Circuits and Timing Diagrams

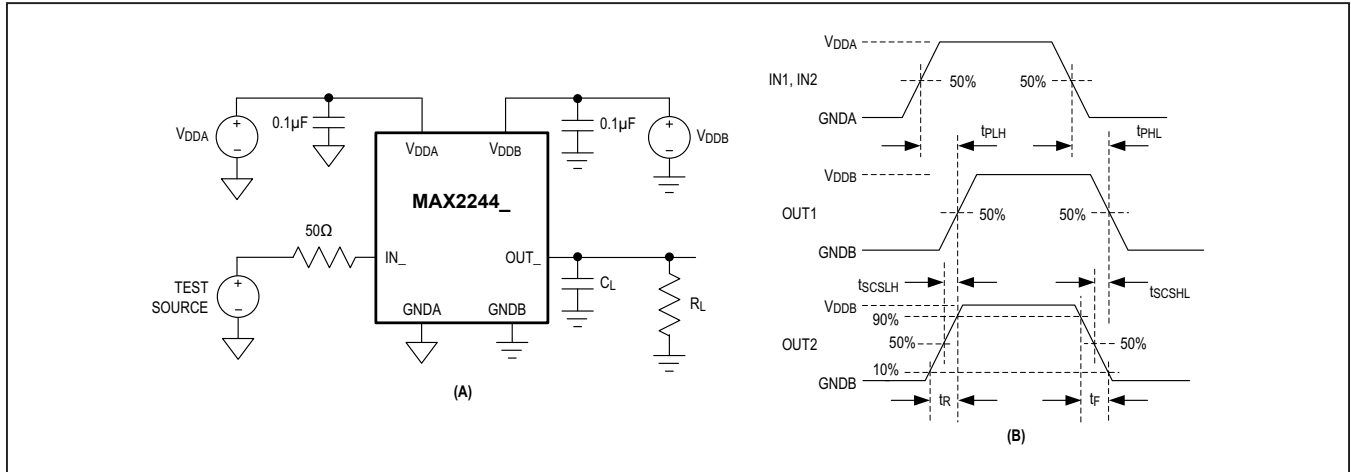

Figure 3. Test Circuit (A) and Timing Diagram (B)

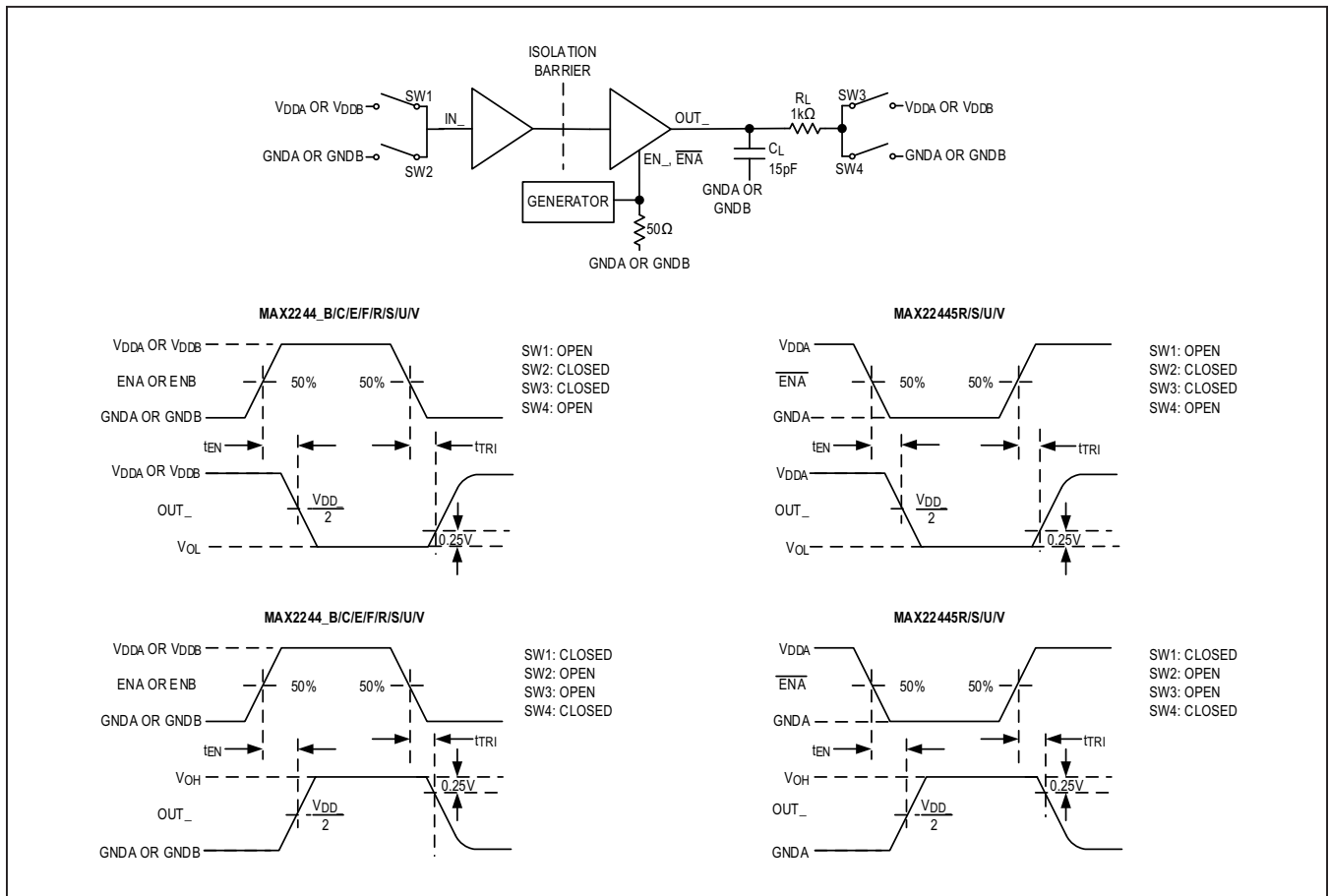
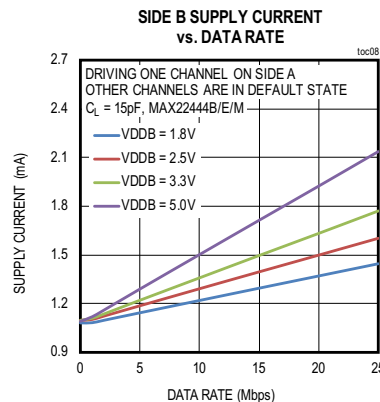
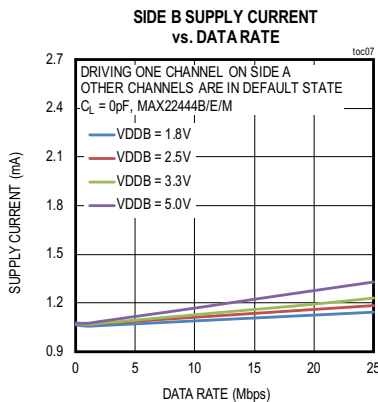
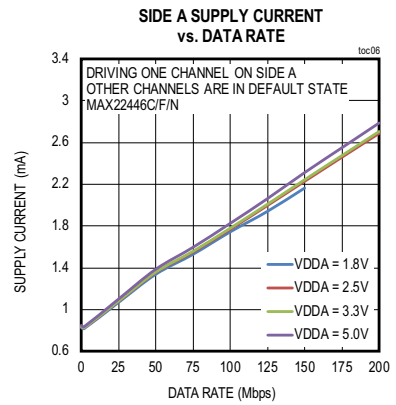
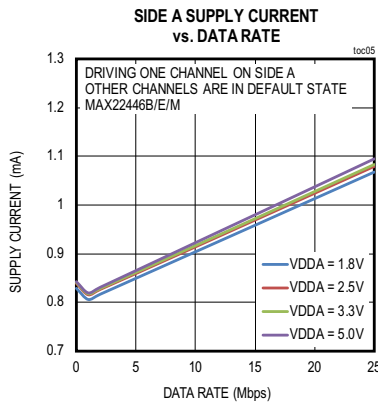
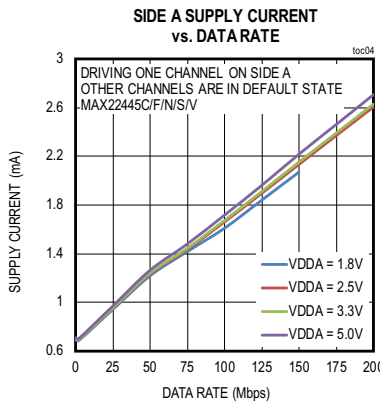
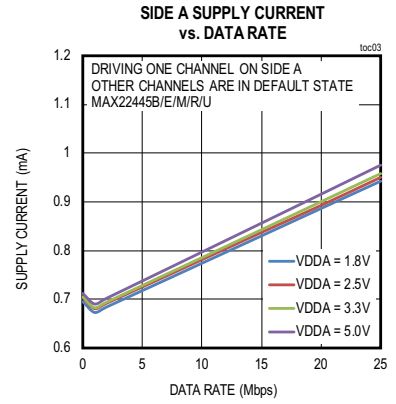
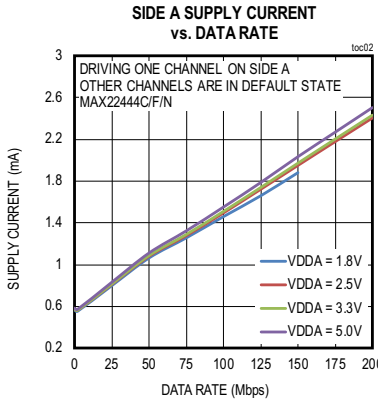
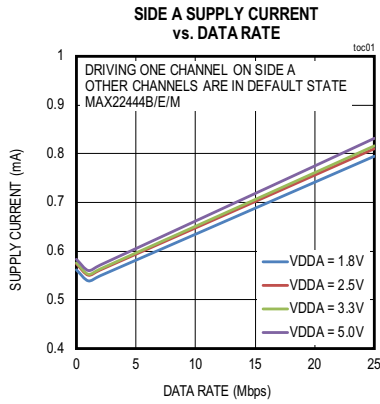

Figure 4. Enable to Output Timing ( $t_{EN}$ ,  $t_{TRI}$ )

Typical Operating Characteristics

( $V_{DDA} - V_{GNDA} = +3.3V$ ,  $V_{DDB} - V_{GNDB} = +3.3V$ ,  $V_{GNDA} = V_{GNDB}$ ,  $T_A = +25^\circ C$ , unless otherwise noted.)



Typical Operating Characteristics (continued)

( $V_{DDA} - V_{GNDA} = +3.3V$ ,  $V_{DDB} - V_{GNDB} = +3.3V$ ,  $V_{GNDA} = V_{GNDB}$ ,  $T_A = +25^\circ C$ , unless otherwise noted.)

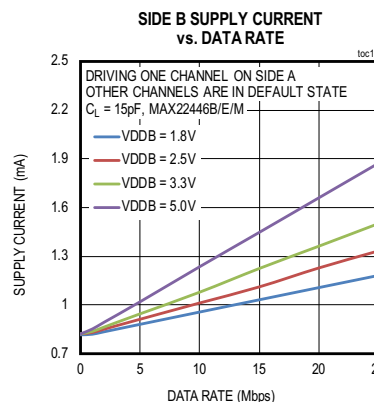
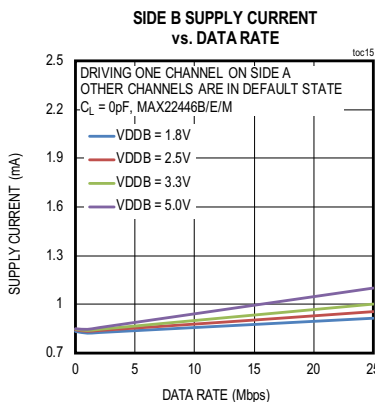
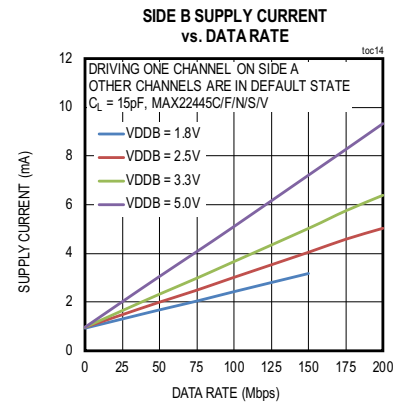
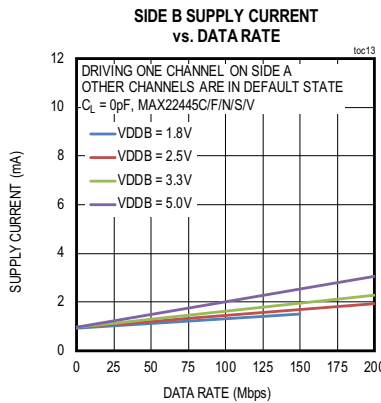
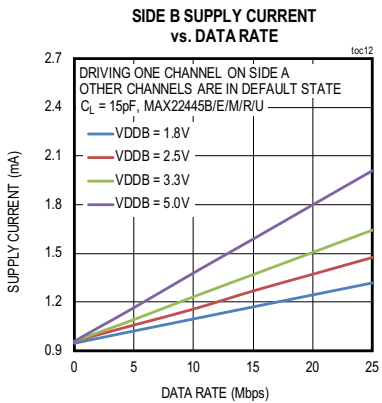
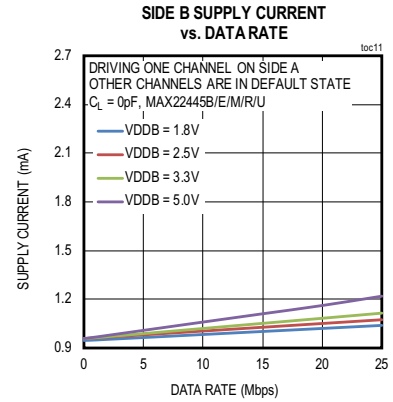
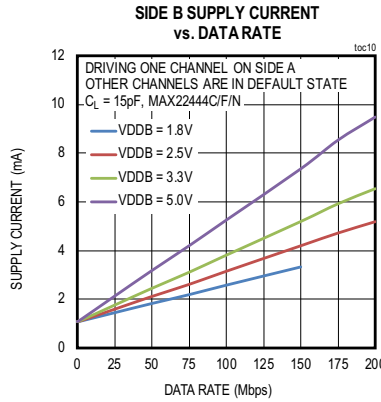
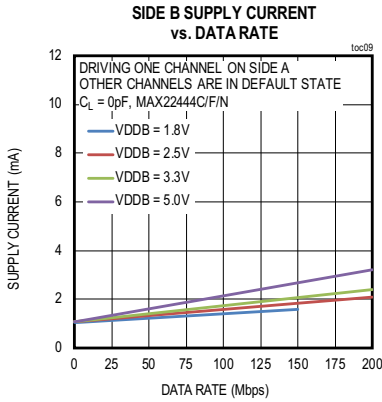

Typical Operating Characteristics (continued)

( $V_{DDA} - V_{GNDA} = +3.3V$ ,  $V_{DDB} - V_{GNDB} = +3.3V$ ,  $V_{GNDA} = V_{GNDB}$ ,  $T_A = +25^\circ C$ , unless otherwise noted.)

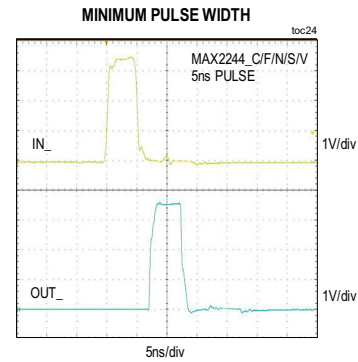
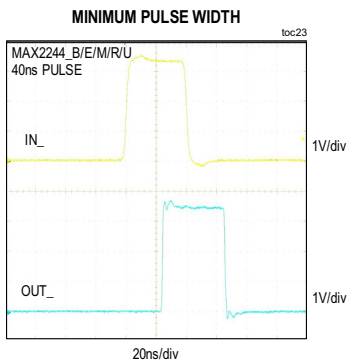
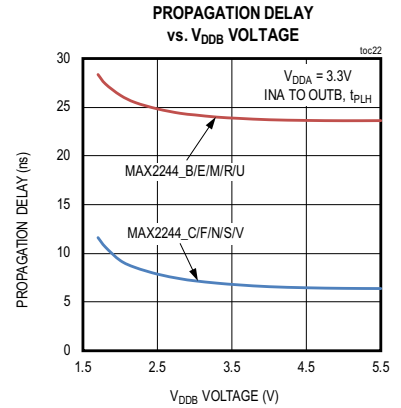
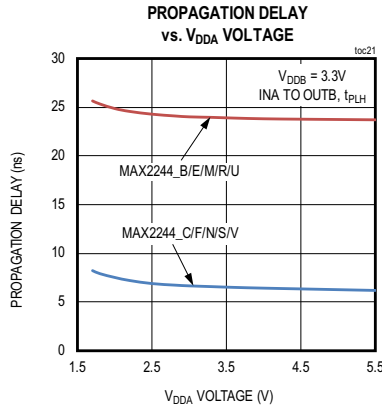
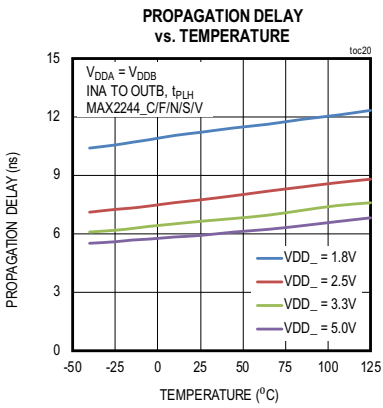
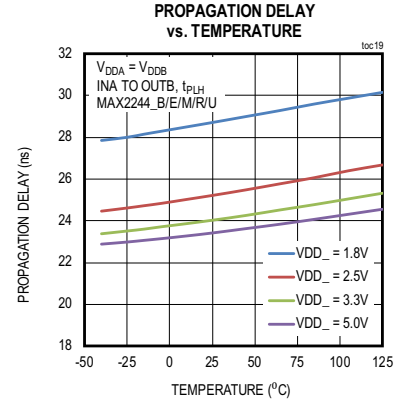
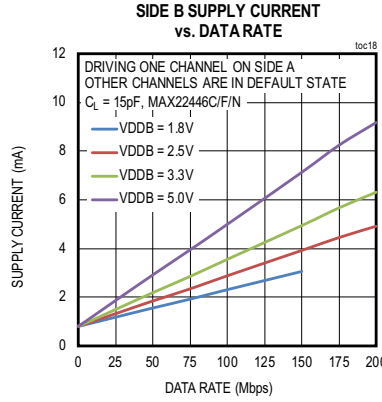
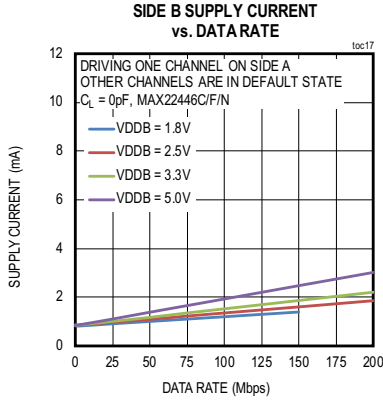

Typical Operating Characteristics (continued)

( $V_{DDA} - V_{GNDA} = +3.3V$ ,  $V_{DDB} - V_{GNDB} = +3.3V$ ,  $V_{GNDA} = V_{GNDB}$ ,  $T_A = +25^\circ C$ , unless otherwise noted.)

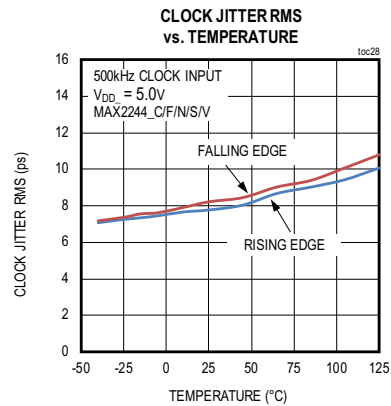
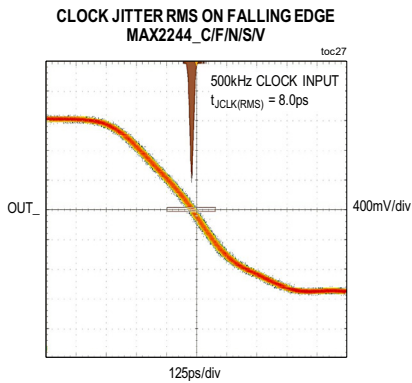
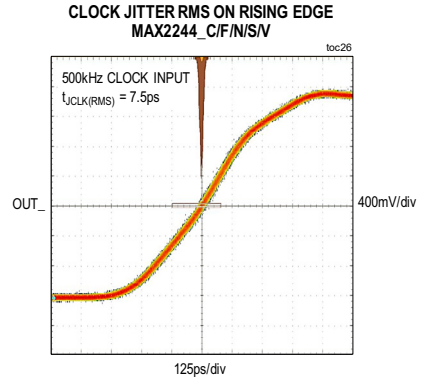
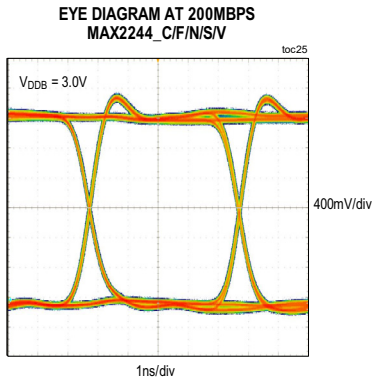



Pin Configurations

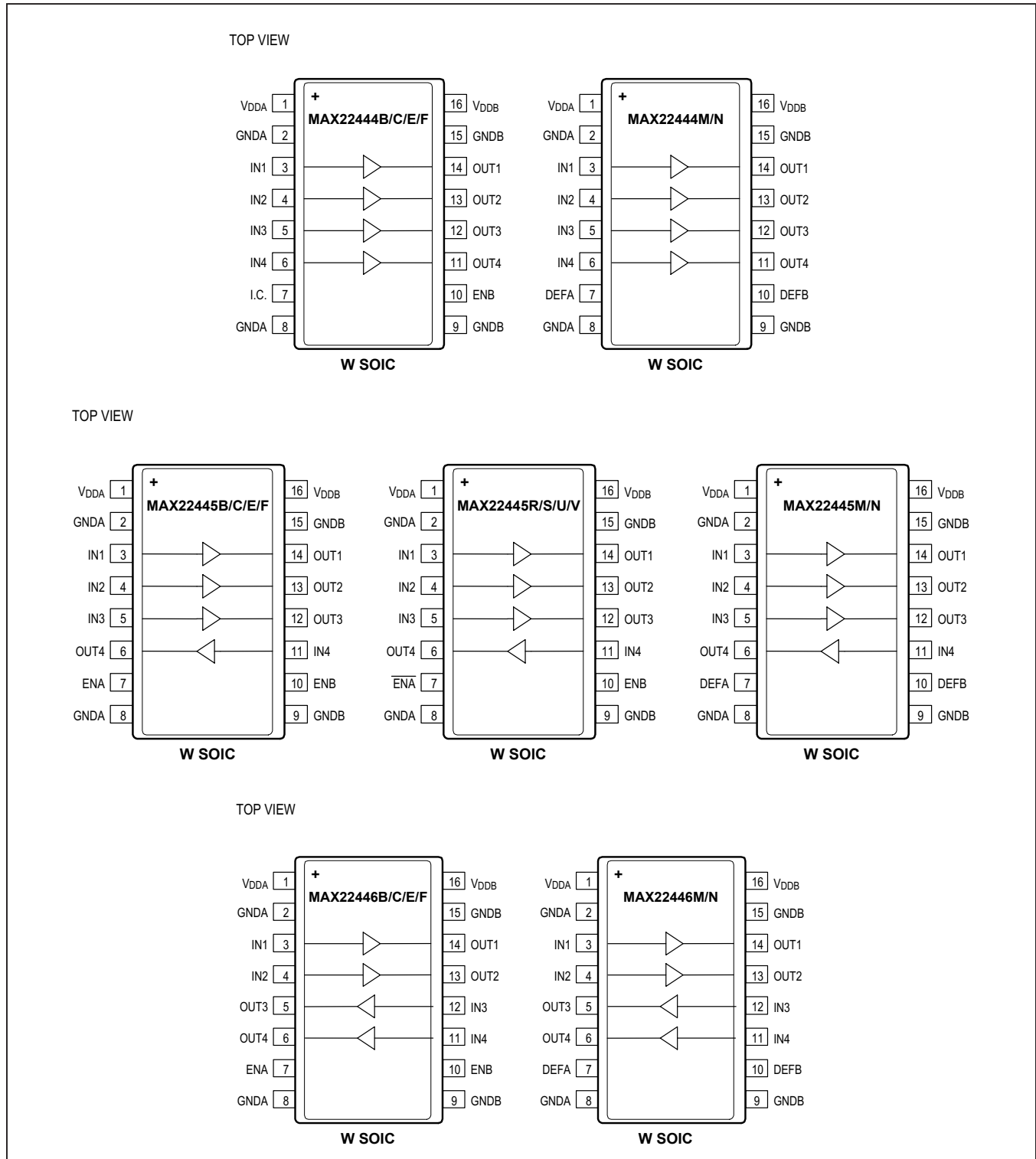

**Pin Description**

NAME	PIN						
	MAX22444 B/C/E/F	MAX22444 M/N	MAX22445 B/C/E/F	MAX22445 R/S/U/V	MAX22445 M/N	MAX22446 B/C/E/F	MAX22446 M/N
V <sub>DDA</sub>	1	1	1	1	1	1	1
G <sub>ND</sub> A	2, 8	2, 8	2, 8	2, 8	2, 8	2, 8	2, 8
IN1	3	3	3	3	3	3	3
IN2	4	4	4	4	4	4	4
IN3	5	5	5	5	5	12	12
IN4	6	6	11	11	11	11	11
I.C.	7	—	—	—	—	—	—
DEFA	—	7	—	—	7	—	7
ENA	—	—	7	—	—	7	—
$\overline{\text{ENA}}$	—	—	—	7	—	—	—
G <sub>ND</sub> B	9, 15	9, 15	9, 15	9, 15	9, 15	9, 15	9, 15
ENB	10	—	10	10	—	10	—
DEFB	—	10	—	—	10	—	10
OUT4	11	11	6	6	6	6	6
OUT3	12	12	12	12	12	5	5
OUT2	13	13	13	13	13	13	13
OUT1	14	14	14	14	14	14	14
V <sub>DD</sub> B	16	16	16	16	16	16	16

## Pin Description (continued)

NAME	FUNCTION
<b>POWER</b>	
V <sub>DDA</sub>	Power Supply Input for Side A. Bypass V <sub>DDA</sub> to GNDA with a 0.1μF ceramic capacitor as close as possible to the pin.
GNDA	Ground Reference for Side A.
V <sub>ddb</sub>	Power Supply Input for Side B. Bypass V <sub>ddb</sub> to GNDB with a 0.1μF ceramic capacitor as close as possible to the pin.
GNDB	Ground Reference for Side B.
<b>INPUTS</b>	
IN1	Logic Input 1 on Side A. Corresponds to Logic Output 1 on Side B.
IN2	Logic Input 2 on Side A. Corresponds to Logic Output 2 on Side B.
IN3	Logic Input 3 on Side A/B. Corresponds to Logic Output 3 on Side B/A.
IN4	Logic Input 4 on Side A/B. Corresponds to Logic Output 4 on Side B/A.
<b>OUTPUTS</b>	
OUT1	Logic Output 1 on Side B. OUT1 is the logic output for the IN1 input on Side A.
OUT2	Logic Output 2 on Side B. OUT2 is the logic output for the IN2 input on Side A.
OUT3	Logic Output 3 on Side B/A. OUT3 is the logic output for the IN3 input on Side A/B.
OUT4	Logic Output 4 on Side B/A. OUT4 is the logic output for the IN4 input on Side A/B.
<b>ENABLE INPUTS</b>	
ENA	Active-High Enable for Side A. ENA has an internal 5μA pull-up to V <sub>DDA</sub> .
$\overline{\text{ENA}}$	Active-Low Enable for Side A. $\overline{\text{ENA}}$ has an internal 5μA pull-down to GNDA.
ENB	Active-High Enable for Side B. ENB has an internal 5μA pull-up to V <sub>ddb</sub> .
<b>DEFAULT CONTROL</b>	
DEFA	Default Control Input for Side A. Connect DEFA to V <sub>DDA</sub> to set side A outputs to a default-high state and to enable the pullup current on side A inputs. Connect DEFA to GNDA to set side A outputs to a default-low state and enable the pulldown current on side A inputs. DEFA must be tied to the same state (high or low) as DEFB.
DEFB	Default Control Input for Side B. Connect DEFB to V <sub>ddb</sub> to set side B outputs to a default-high state and to enable the pullup current on side B inputs. Connect DEFB to GNDB to set side B outputs to a default-low state and enable the pulldown current on side B inputs. DEFB must be tied to the same state (high or low) as DEFA.
<b>INTERNALLY CONNECTED</b>	
I.C.	Internally Connected. Leave unconnected or connect to GNDA or V <sub>DDA</sub> .

Functional Diagrams

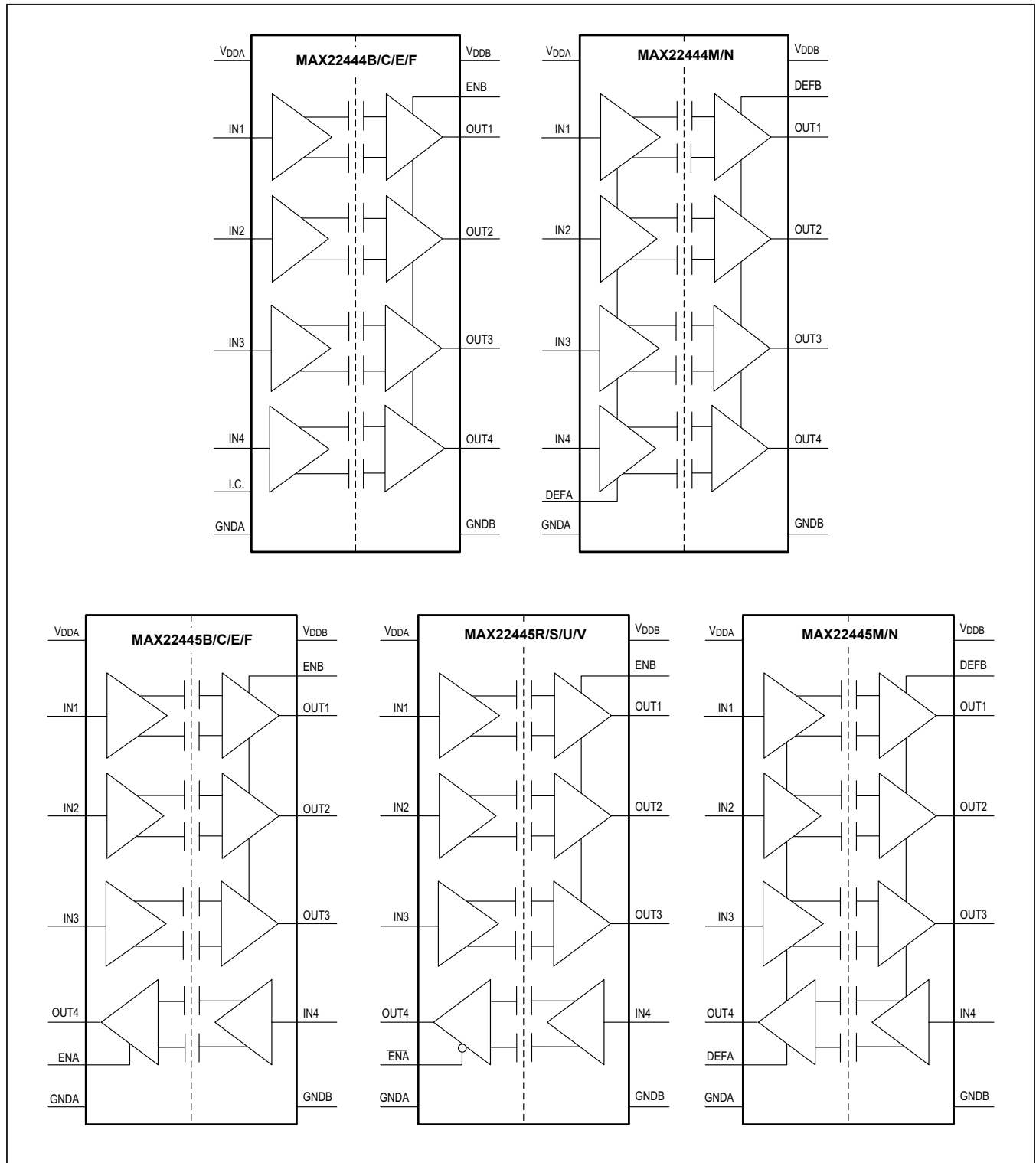

Functional Diagrams (continued)

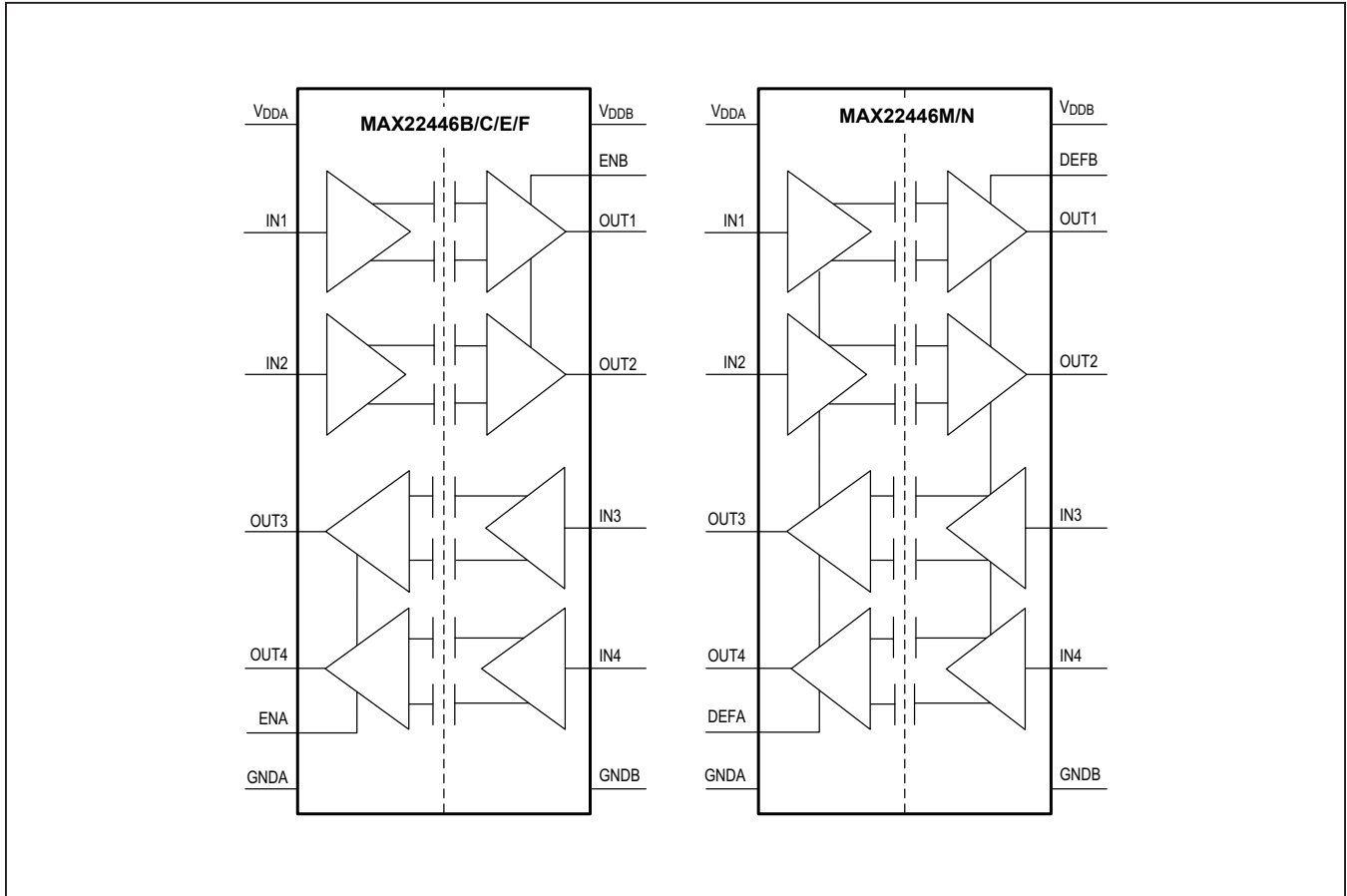

### Detailed Description

The MAX22444–MAX22446 are a family of 4-channel reinforced digital isolators. The MAX22444–MAX22446 have an isolation rating of 5kV<sub>RMS</sub>. The MAX22444–MAX22446 family offers all possible unidirectional channel configurations to accommodate any 4-channel design, including SPI, RS-232, RS-485, and digital I/O applications. For applications requiring bidirectional channels, such as I<sup>2</sup>C, see the MAX14933 and MAX14937.

The MAX22444 features four channels transferring digital signals in one direction for applications such as isolated digital I/O. The MAX22445 has three channels transmitting data in one direction and one channel transmitting in the opposite direction, making them ideal for applications such as isolated SPI and RS-485 communication. The MAX22446 provides further design flexibility with two channels in each direction for isolated RS-232 or other applications.

Devices are available in a 16-pin wide-body SOIC package and are rated for up to 5kV<sub>RMS</sub>. This family of digital isolators offers low-power operation, high electromagnetic interference (EMI) immunity, and stable temperature performance through Maxim’s proprietary process technology. The devices isolate different ground domains and block high-voltage/high-current transients from sensitive or human interface circuitry.

Devices are available with a maximum data rate of either 25Mbps (B/E/M/R/U versions) or 200Mbps (C/F/N/S/V versions). The MAX2244\_B/C/R/S feature default-high outputs. The MAX2244\_E/F/U/V feature default-low outputs. The MAX2244\_M/N feature user-selectable default-high or default-low outputs. The default is the state the output assumes when the input is not powered or if the input is open-circuit. The devices have two supply inputs (V<sub>DDA</sub> and V<sub>DDB</sub>) that independently set the logic levels on either side of the device. V<sub>DDA</sub> and V<sub>DDB</sub> are referenced to GNDA and GNDB, respectively. The MAX22444–MAX22446 also

feature a refresh circuit to ensure output accuracy when an input remains in the same state indefinitely.

### Digital Isolation

The MAX22444–MAX22446 provide reinforced galvanic isolation for digital signals that are transmitted between two ground domains. The devices withstand differences of up to 5kV<sub>RMS</sub> for up to 60 seconds, and up to 2121V<sub>PEAK</sub> of continuous isolation.

### Level-Shifting

The wide supply voltage range of both V<sub>DDA</sub> and V<sub>DDB</sub> allows the MAX22444–MAX22446 to be used for level translation in addition to isolation. V<sub>DDA</sub> and V<sub>DDB</sub> can be independently set to any voltage from 1.71V to 5.5V. The supply voltage sets the logic level on the corresponding side of the isolator.

### Unidirectional Channels

Each channel of the MAX22444–MAX22446 is unidirectional; it only passes data in one direction, as indicated in the functional diagram. Each device features four unidirectional channels that operate independently with guaranteed data rates from DC up to 25Mbps (B/E/M/R/U versions), or from DC to 200Mbps (C/F/N/S/V versions). The output driver of each channel is push-pull, eliminating the need for pullup resistors. The outputs are able to drive both TTL and CMOS logic inputs.

### Startup and Undervoltage-Lockout

The V<sub>DDA</sub> and V<sub>DDB</sub> supplies are both internally monitored for undervoltage conditions. Undervoltage events can occur during power-up, power-down, or during normal operation due to a sagging supply voltage. When an undervoltage condition is detected on either supply while the outputs are enabled, all outputs go to their default states regardless of the state of the inputs (Table 3, Table 4, Table 5). Figure 5 through Figure 8 show the behavior of the outputs during power-up and power-down.

**Table 3. MAX2244\_B/C/E/F Output Behavior During Undervoltage Conditions**

V <sub>IN_</sub>	V <sub>DDA</sub>	V <sub>DDB</sub>	ENA	ENB	V <sub>OUTA</sub>	V <sub>OUTB</sub>
1	Powered	Powered	1	1	High	High
			0	0	Hi-Z	Hi-Z
0	Powered	Powered	1	1	Low	Low
			0	0	Hi-Z	Hi-Z
X	Undervoltage	Powered	1	1	Default	Default
			0	0	Hi-Z	Hi-Z
X	Powered	Undervoltage	1	1	Default	Default
			0	0	Hi-Z	Hi-Z

**Table 4. MAX22445R/S/U/V Output Behavior During Undervoltage Conditions**

V <sub>IN_</sub>	V <sub>DDA</sub>	V <sub>DDB</sub>	$\overline{\text{ENA}}$	ENB	V <sub>OUTA</sub>	V <sub>OUTB</sub>
1	Powered	Powered	0	1	High	High
			1	0	Hi-Z	Hi-Z
0	Powered	Powered	0	1	Low	Low
			1	0	Hi-Z	Hi-Z
X	Undervoltage	Powered	0	1	Default	Default
			1	0	Hi-Z	Hi-Z
X	Powered	Undervoltage	0	1	Default	Default
			1	0	Hi-Z	Hi-Z

**Table 5. MAX2244\_M/N Output Behavior During Undervoltage Conditions**

V <sub>IN_</sub>	V <sub>DDA</sub>	V <sub>DDB</sub>	DEFA = DEFB	V <sub>OUTA</sub>	V <sub>OUTB</sub>
1	Powered	Powered	1	High	High
			0	High	High
0	Powered	Powered	1	Low	Low
			0	Low	Low
X	Undervoltage	Powered	1	Default (High)	Default (High)
			0	Default (Low)	Default (Low)
X	Powered	Undervoltage	1	Default (High)	Default (High)
			0	Default (Low)	Default (Low)

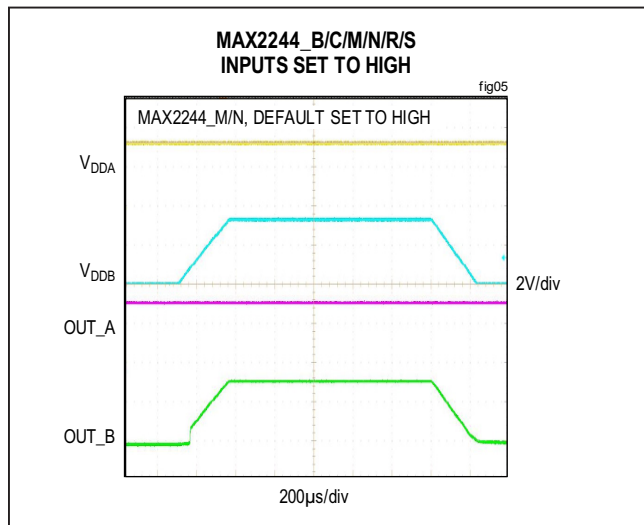

Figure 5. Undervoltage Lockout Behavior (MAX2244\_B/C/M/N/R/S with Inputs High)

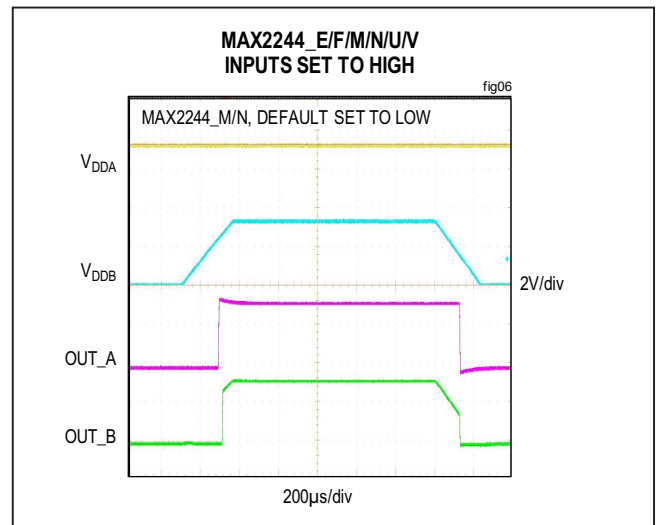

Figure 6. Undervoltage Lockout Behavior (MAX2244\_E/F/M/N/U/V with Inputs High)

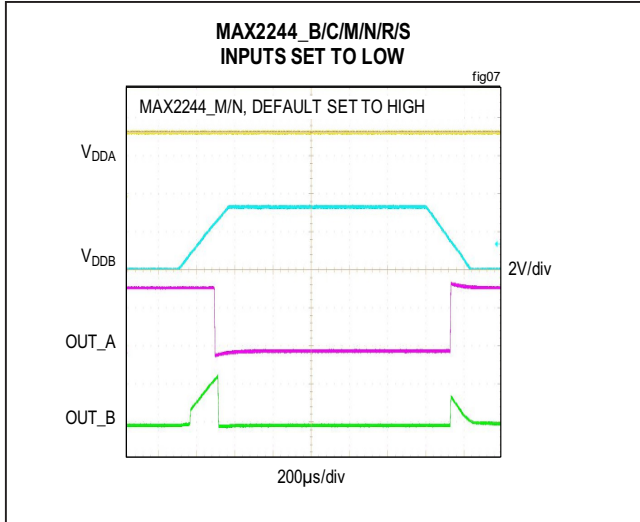

Figure 7. Undervoltage Lockout Behavior (MAX2244\_B/C/M/N/R/S with Inputs Low)

**Selectable Output Default (DEFA, DEFB) (MAX2244\_M/N Only)**

The default is the state the output assumes when the input is not powered or if the input is open circuit. The MAX2244\_M/N feature user-selectable default-high or default-low outputs. Set both DEFA and DEFB high to set all channels to default-high, or set both DEFA and DEFB low to set all channels to default-low.

Ensure the logic state (high or low) of DEFA is the same as that for DEFB. Do not toggle DEFA or DEFB during normal operation.

**Applications Information**

**Power-Supply Sequencing**

The MAX22444-MAX22446 do not require special power supply sequencing. The logic levels are set independently on either side by VDDA and VDDB. Each supply can be present over the entire specified range regardless of the level or presence of the other supply.

**Power-Supply Decoupling**

To reduce ripple and the chance of introducing data errors, bypass VDDA and VDDB with 0.1µF low-ESR ceramic capacitors to GNDA and GNDB, respectively. Place the bypass capacitors as close to the power supply input pins as possible.

**Layout Considerations**

The PCB designer should follow some critical recommendations in order to get the best performance from the design.

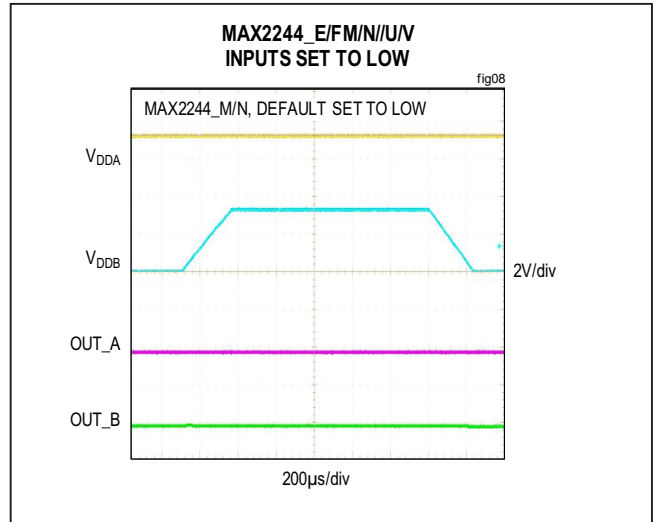

Figure 8. Undervoltage Lockout Behavior (MAX2244\_E/F/M/N/U/V with Inputs Low)

- Keep the input/output traces as short as possible. To keep signal paths low-inductance, avoid using vias.
- Have a solid ground plane underneath the high-speed signal layer.
- Keep the area underneath the MAX22444-MAX22446 free from ground and signal planes. Any galvanic or metallic connection between the Side A and Side B defeats the isolation.

**Calculating Power Dissipation**

The required current for a given supply (VDDA or VDDB) can be estimated by summing the current required for each channel. The supply current for a channel depends on whether the channel is an input or an output, the channel’s data rate, and the capacitive or resistive load if it is an output. The typical current for an input or output at any data rate can be estimated from the graphs in Figure 9 and Figure 10. Please note that the data in Figure 9 and Figure 10 are extrapolated from the supply current measurements in a typical operating condition.

The total current for a single channel is the sum of the “no load” current (shown in Figure 9 and Figure 10) which is a function of Voltage and Data Rate, and the “load current,” which depends on the type of load. Current into a capacitive load is a function of the load capacitance, the switching frequency, and the supply voltage.

$$I_{CL} = C_L \times f_{sw} \times V_{DD}$$

where

I<sub>CL</sub> is the current required to drive the capacitive load.

C<sub>L</sub> is the load capacitance on the isolator’s output pin.



$f_{SW}$  is the switching frequency (bits per second / 2).  
 $V_{DD}$  is the supply voltage on the output side of the isolator.  
 Current into a resistive load depends on the load resistance, the supply voltage and the average duty cycle of the data waveform. The DC load current can be conservatively estimated by assuming the output is always high.

$$I_{RL} = V_{DD} \div R_L$$

where

$I_{RL}$  is the current required to drive the resistive load.  
 $V_{DD}$  is the supply voltage on the output side of the isolator.  
 $R_L$  is the load resistance on the isolator's output pin.

**Example** (shown in [Figure 11](#)): A MAX22445 is operating with  $V_{DDA} = 2.5V$ ,  $V_{DDB} = 3.3V$ , channel 1 operating at 20Mbps with a 10pF capacitive load, channel 2 held high with a 10kΩ resistive load, and channel 4 operating at 100Mbps with a 15pF capacitive load. Channel 3 is not in use and the resistive load is negligible since the isolator is driving a CMOS input. Refer to [Table 6](#) and [Table 7](#) for  $V_{DDA}$  and  $V_{DDB}$  supply current calculation worksheets.

**$V_{DDA}$  must supply:**

- Channel 1 is an input channel operating at 2.5V and 20Mbps, consuming 0.33mA, estimated from [Figure 9](#).
- Channel 2 and 3 are input channels operating at 2.5V with DC signal, consuming 0.14mA, estimated from [Figure 9](#).

- Channel 4 is an output channel operating at 2.5V and 100Mbps, consuming 0.77mA, estimated from [Figure 10](#).
- $I_{CL}$  on channel 4 for 15pF capacitor at 2.5V and 100Mbps is 1.875mA.

**Total current for side A = 0.33 + 0.14 × 2 + 0.77 + 1.875 = 3.255mA, typical**

**$V_{DDB}$  must supply:**

- Channel 1 is an output channel operating at 3.3V and 20Mbps, consuming 0.40mA, estimated from [Figure 10](#).
- Channel 2 and 3 are output channels operating at 3.3V with DC signal, consuming 0.27mA, estimated from [Figure 10](#).
- Channel 4 is an input channel operating at 3.3V and 100Mbps, consuming 1.11mA, estimated from [Figure 9](#).
- $I_{CL}$  on channel 1 for 10pF capacitor at 3.3V and 20Mbps is 0.33mA.
- $I_{RL}$  on channel 2 for 10kΩ resistor held at 3.3V is 0.33mA.

**Total current for side B = 0.40 + 0.27 × 2 + 1.11 + 0.33 + 0.33 = 2.71mA, typical**

**Table 6. Side A Supply Current Calculation Worksheet**

SIDE A		$V_{DDA} = 2.5V$				
Channel	IN/OUT	Data Rate (Mbps)	Load Type	Load	"No Load" Current (mA)	Load Current (mA)
1	IN	20			0.33	
2	IN	0			0.14	
3	IN	0			0.14	
4	OUT	100	Capacitive	15pF	0.77	$2.5V \times 50MHz \times 15pF = 1.875mA$
Total: 3.26mA						

**Table 7. Side B Supply Current Calculation Worksheet**

SIDE B		$V_{DDB} = 3.3V$				
Channel	IN/OUT	Data Rate (Mbps)	Load Type	Load	"No Load" Current (mA)	Load Current (mA)
1	OUT	20	Capacitive	10pF	0.40	$3.3V \times 10MHz \times 10pF = 0.33mA$
2	OUT	0	Resistive	10kΩ	0.27	$3.3V / 10k\Omega = 0.33mA$
3	OUT	0			0.27	
4	IN	100			1.11	
Total: 2.71mA						

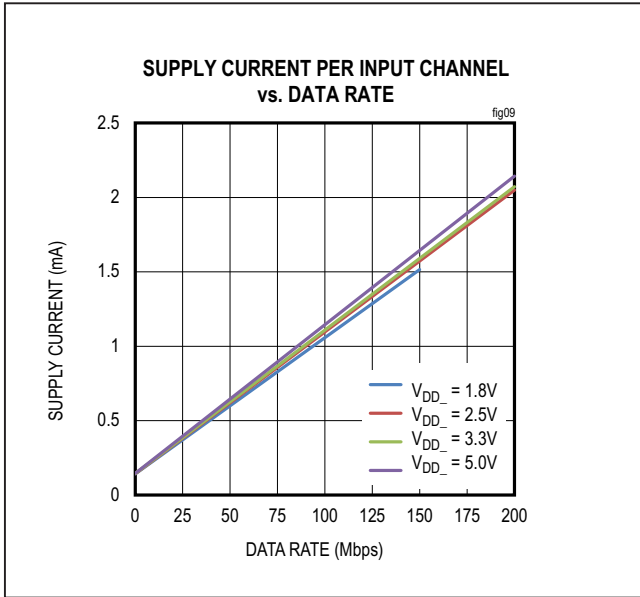

Figure 9. Supply Current Per Input Channel (Estimated)

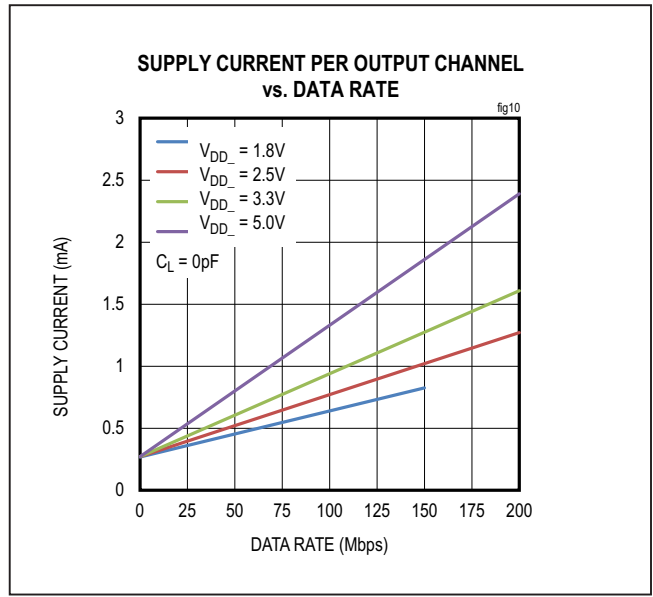

Figure 10. Supply Current Per Output Channel (Estimated)

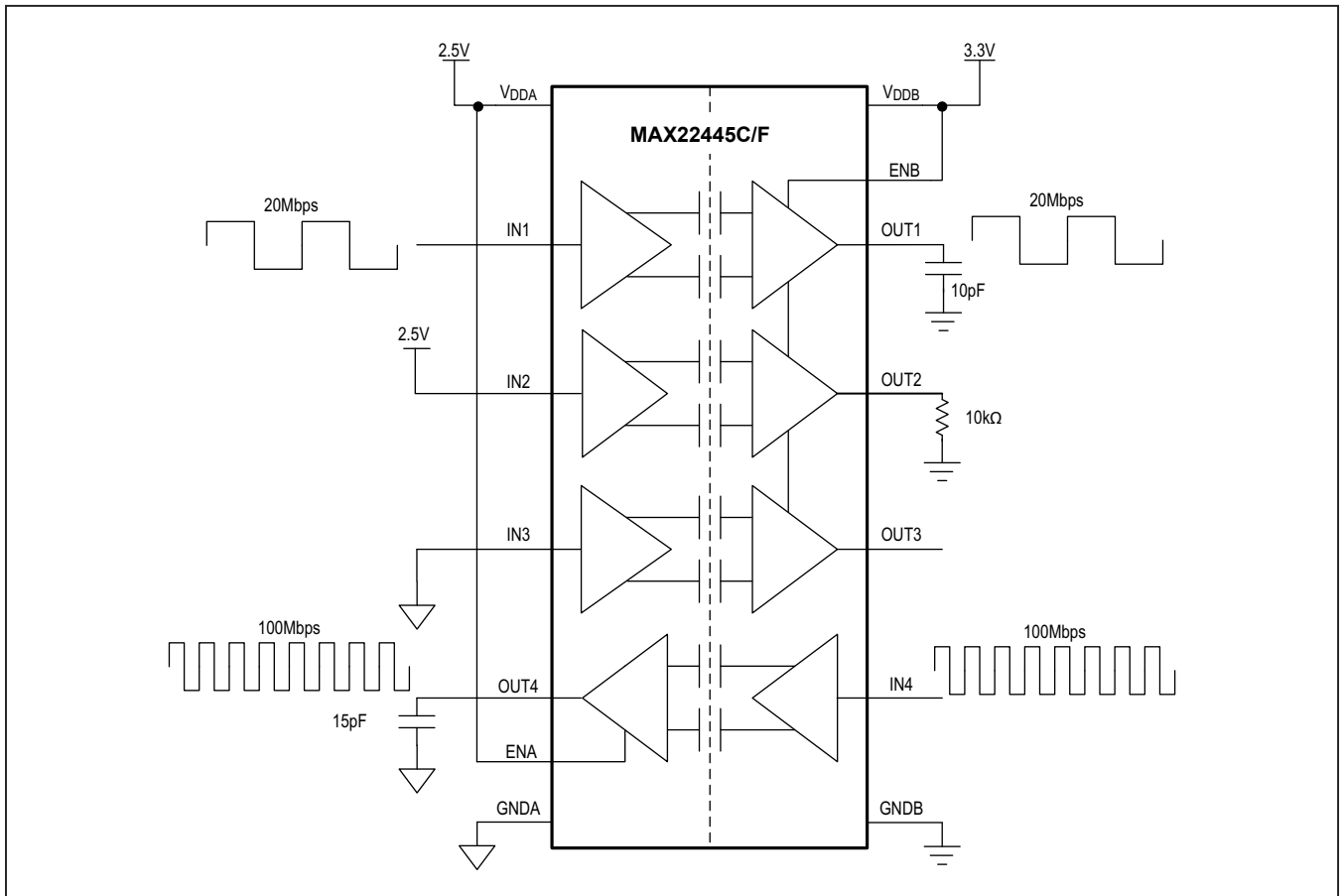
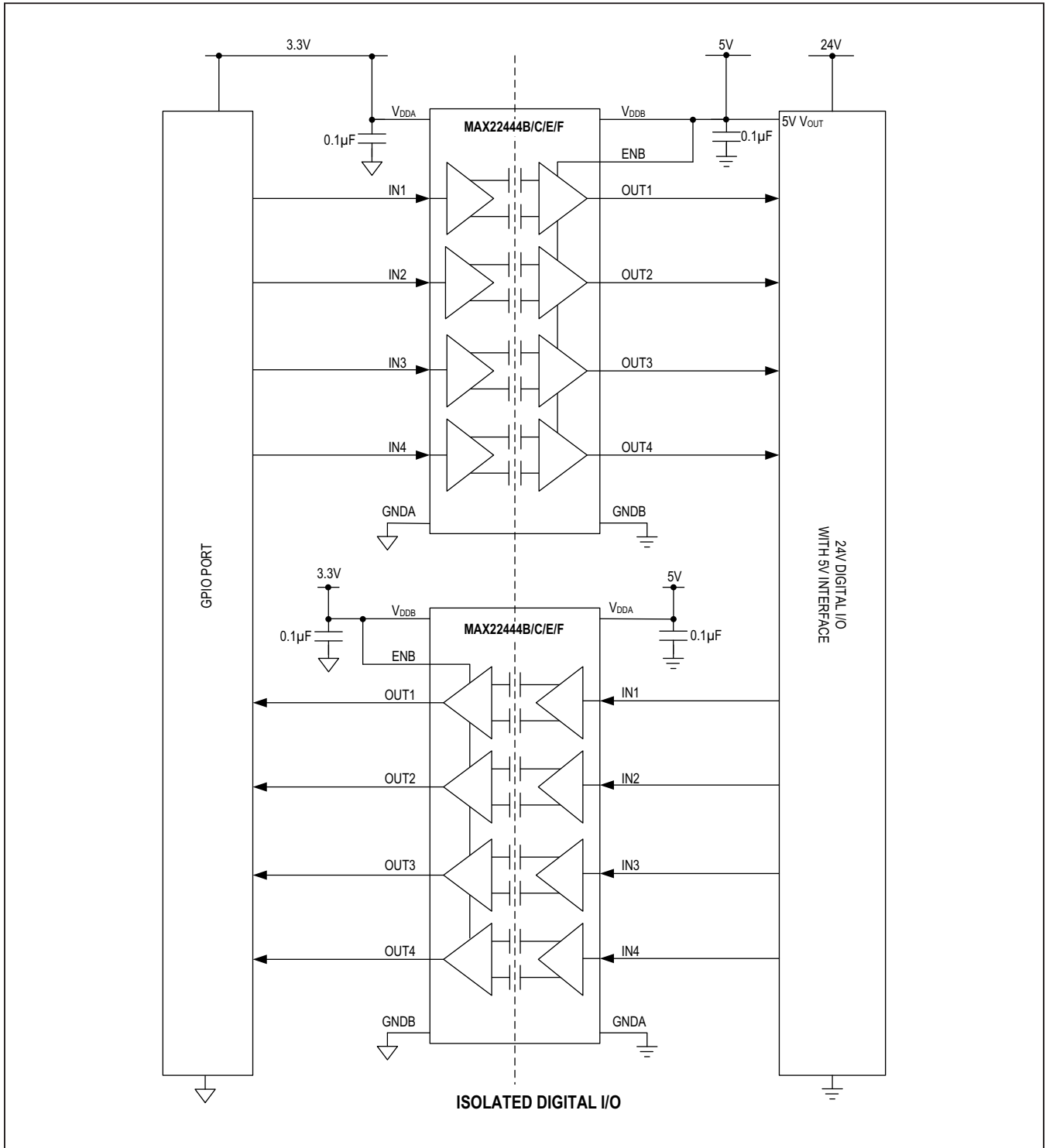
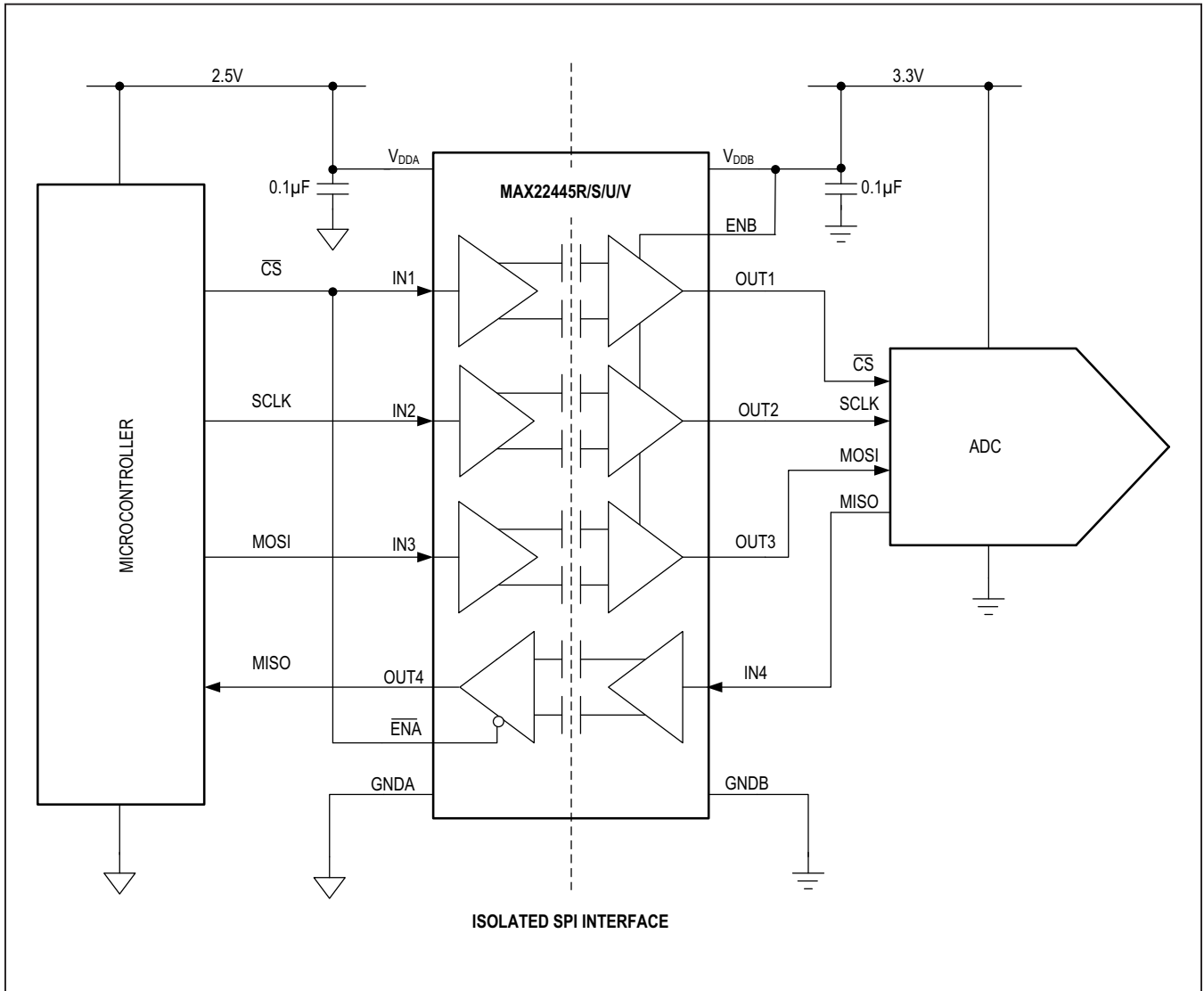

Figure 11. Example Circuit for Supply Current Calculation

Typical Application Circuits



Typical Application Circuits (continued)



Typical Application Circuits (continued)

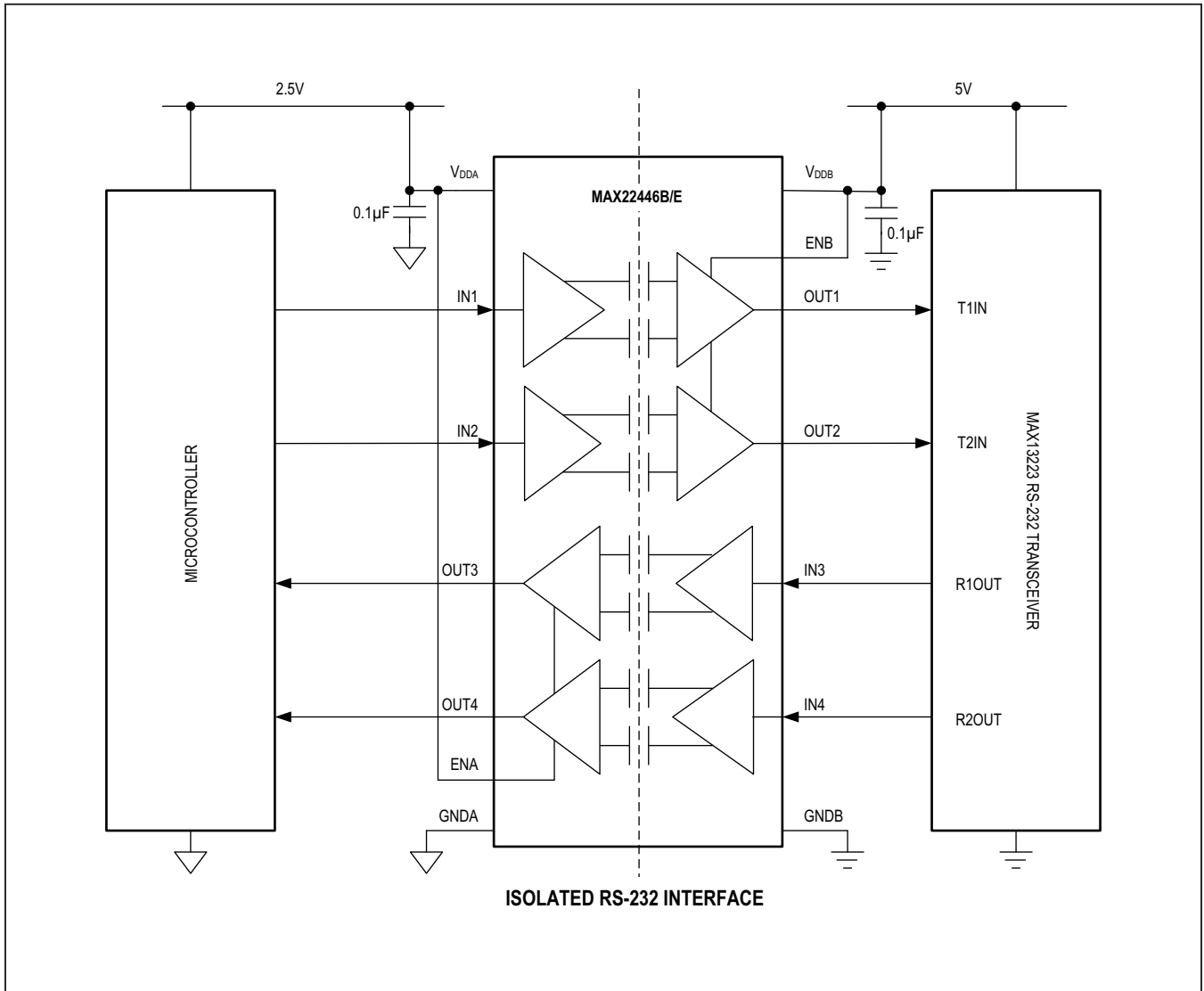

Product Selector Guide

DEVICE CONFIGURATION	ACTIVE-HIGH EN <sub>-</sub>		ACTIVE-LOW ENA	
	MAX DATA RATE		MAX DATA RATE	
	25Mbps	200Mbps	25Mbps	200Mbps
DEFAULT-HIGH OUTPUT	B	C	R	S
DEFAULT-LOW OUTPUT	E	F	U	V
SELECTABLE DEFAULT OUTPUT STATE	M	N	—	—

**MAX2244** 4 B A W E +  
 CHANNEL CONFIGURATION: 4: 4/0, 5: 3/1, 6: 2/2  
 MAXIMUM DATA RATE: 25, 200  
 DEFAULT OUTPUT: High, Low  
 ENA POLARITY (SEE TABLE)  
 TEMP RANGE: -40° C TO +125° C  
 PACKAGE: W SOIC  
 PINS: 16  
 LEAD-FREE/ROHS COMPLIANT

Ordering Information

PART	CHANNEL CONFIGURATION	DATA RATE (Mbps)	DEFAULT OUTPUT	ENA POLARITY	ISOLATION VOLTAGE (kV <sub>RMS</sub> )	TEMP RANGE (°C)	PIN-PACKAGE
MAX22444BAWE+*	4/0	25	Default High	Active-High	5	-40 to +125	16 Wide SOIC
MAX22444CAWE+	4/0	200	Default High	Active-High	5	-40 to +125	16 Wide SOIC
MAX22444EAW E+*	4/0	25	Default Low	Active-High	5	-40 to +125	16 Wide SOIC
MAX22444FAWE+	4/0	200	Default Low	Active-High	5	-40 to +125	16 Wide SOIC
MAX22444MAWE+*	4/0	25	Selectable	—	5	-40 to +125	16 Wide SOIC
MAX22444NAWE+*	4/0	200	Selectable	—	5	-40 to +125	16 Wide SOIC
MAX22445BAWE+*	3/1	25	Default High	Active-High	5	-40 to +125	16 Wide SOIC
MAX22445CAWE+	3/1	200	Default High	Active-High	5	-40 to +125	16 Wide SOIC
MAX22445EAW E+	3/1	25	Default Low	Active-High	5	-40 to +125	16 Wide SOIC
MAX22445FAWE+	3/1	200	Default Low	Active-High	5	-40 to +125	16 Wide SOIC
MAX22445MAWE+*	3/1	25	Selectable	—	5	-40 to +125	16 Wide SOIC
MAX22445NAWE+*	3/1	200	Selectable	—	5	-40 to +125	16 Wide SOIC
MAX22445RAW E+	3/1	25	Default High	Active-Low	5	-40 to +125	16 Wide SOIC
MAX22445SAWE+*	3/1	200	Default High	Active-Low	5	-40 to +125	16 Wide SOIC
MAX22445UAW E+*	3/1	25	Default Low	Active-Low	5	-40 to +125	16 Wide SOIC
MAX22445VAWE+*	3/1	200	Default Low	Active-Low	5	-40 to +125	16 Wide SOIC
MAX22446BAWE+*	2/2	25	Default High	Active-High	5	-40 to +125	16 Wide SOIC
MAX22446CAWE+	2/2	200	Default High	Active-High	5	-40 to +125	16 Wide SOIC
MAX22446EAW E+	2/2	25	Default Low	Active-High	5	-40 to +125	16 Wide SOIC
MAX22446FAWE+*	2/2	200	Default Low	Active-High	5	-40 to +125	16 Wide SOIC
MAX22446MAWE+*	2/2	25	Selectable	—	5	-40 to +125	16 Wide SOIC
MAX22446NAWE+*	2/2	200	Selectable	—	5	-40 to +125	16 Wide SOIC

\*Future Product—Contact Maxim for availability.

+Denotes a lead(Pb)-free/RoHS-compliant package.

Chip Information

PROCESS: BiCMOS

## Revision History

REVISION NUMBER	REVISION DATE	DESCRIPTION	PAGES CHANGED
0	2/18	Initial release	—
1	10/18	Removed Future Product designation from MAX22446CAWE+	30
2	1/19	Updated <i>Safety Regulatory Approvals</i> section and added a <i>Safety Regulatory Approvals</i> table	1, 10
3	3/19	Updated <i>General Description</i> and Table 1	1, 10
4	9/19	Updated <i>Safety Regulatory Approvals</i> section and added a <i>Safety Regulatory Approvals</i> table; Corrected typo in Revision History table	1, 10, 31
5	10/19	Updated the <i>General Description</i> section and the <i>Safety Regulatory Approvals</i> table	1, 10
6	1/20	Removed future product designation from MAX2245EAW+	30
7	3/20	Removed future product designation from MAX22445RAW+	30
8	1/21	Updated the <i>Benefits and Features</i> , <i>Electrical Characteristics</i> and <i>Typical Operating Circuits</i> section, and removed future product designation from MAX22444CAWE+ and MAX22446EAW+ in the <i>Ordering Information</i>	1, 10, 27–30
9	9/21	Updated <i>General Description</i> , <i>Safety Regulatory Approvals</i> , Table 2, Figures 9 and 10, and <i>Ordering Information</i> table	1, 10, 11, 26, 30
10	2/22	Updated Table 1, <i>Safety Regulatory Approvals</i> , Captions of Figures 5–8, and <i>Ordering Information</i> table	10, 23, 24, 30



# Mouser Electronics

Authorized Distributor

Click to View Pricing, Inventory, Delivery & Lifecycle Information:

[Analog Devices Inc.:](#)

[MAX22445FAWE+](#) [MAX22445FAWE+T](#) [MAX22446CAWE+](#) [MAX22446CAWE+T](#) [MAX22445EAW+](#)  
[MAX22445EAW+T](#) [MAX22445RAW+](#) [MAX22445RAW+T](#) [MAX22444CAWE+](#) [MAX22446EAW+](#)  
[MAX22444FAWE+](#) [MAX22444FAWE+T](#) [MAX22444CAWE+T](#) [MAX22445CAWE+](#) [MAX22445CAWE+T](#)  
[MAX22446EAW+T](#)