

Reinforced, Fast, Low-Power, Six-Channel Digital Isolators

MAX22163–MAX22166

Product Highlights

- **AEC-Q100 Qualification for /V Devices**
- Reinforced Galvanic Isolation for Digital Signals
 - 16-QSOP with 4mm Creepage and Clearance
 - Withstands 3kV_{RMS} for 60s (V_{ISO})
 - Continuously Withstands 445V_{RMS} (V_{IOWM})
 - Withstands ± 10 kV Surge Between GNDA and GNDB with 1.2/50 μ s Waveform
 - High CMTI (50kV/ μ s, typ)
- Low Power Consumption
 - 0.71mW per Channel at 1Mbps with $V_{DD} = 1.8$ V
 - 1.34mW per Channel at 1Mbps with $V_{DD} = 3.3$ V
 - 3.21mW per Channel at 100Mbps with $V_{DD} = 1.8$ V
- Low Propagation Delay and Low Jitter
 - Maximum Data Rate up to 200Mbps
 - Low Propagation Delay 7ns (typ) at $V_{DD} = 3.3$ V
 - Clock Jitter RMS 11.1ps (typ)
- Safety Regulatory Approvals
 - UL According to UL1577
 - cUL According to CSA Bulletin 5A
 - VDE 0884-11 Reinforced Insulation (Pending)

Key Applications

- Automotive
 - Hybrid Electric Vehicle
 - Chargers
 - Battery Management System (BMS)
 - Inverters

The MAX22163–MAX22166 are a family of six-channel, reinforced, fast, low-power digital galvanic isolators using Analog Devices' proprietary process technology. All devices feature reinforced isolation with a withstand voltage rating of 3kV_{RMS} for 60 seconds. Both automotive and general-purpose devices are rated for operation at ambient temperature from -40°C to +125°C.

Devices with /V suffix are AEC-Q100 qualified. See the [Ordering Information](#) for all automotive grade part numbers.

- Industrial
 - Isolated SPI, RS-232/422/485, CAN, Digital I/O
 - Fieldbus Communications
 - Motor Control
 - Medical Systems

These devices transfer digital signals between circuits with different power domains, using as little as 0.71mW per channel at 1Mbps (1.8V supply). The low-power

Simplified Application Diagram

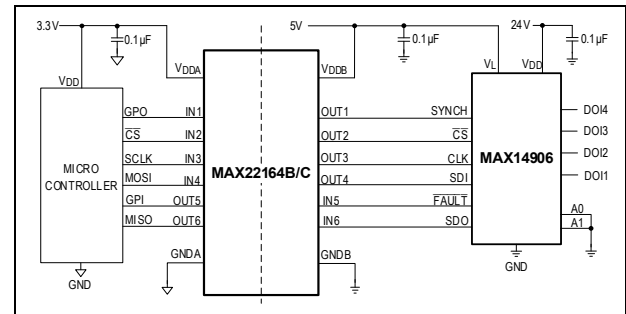

Pin Description

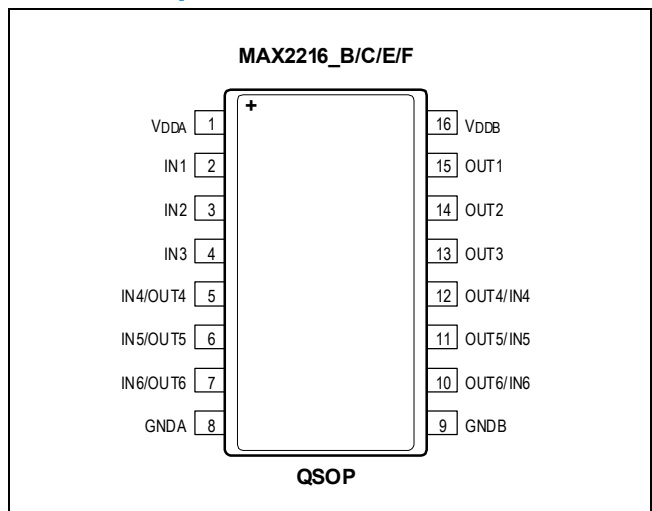

feature reduces system dissipation, increases reliability, and enables compact designs. Devices are available with a maximum data rate of either 25Mbps or 200Mbps and with default-high or default-low outputs. The devices feature low propagation delay and low clock jitter, which reduces system latency.

Independent 1.71V to 5.5V supplies on each side also make the devices suitable for use as level translators.

The MAX22163 features three channels transmitting digital signals in one direction and three in opposite; the MAX22164 offers four channels transmitting digital signals in one direction and two in opposite; the MAX22165 provides five channels transmitting digital signals in one direction and one in opposite; the MAX22166 features all six channels transmitting digital signals in one direction.

[Ordering Information](#) appears at end of data sheet.

Absolute Maximum Ratings

V _{DDA} to GNDA.....	-0.3V to +6V	OUT_ on Side B to GNDB.....	±30mA
V _{ddb} to GNDB.....	-0.3V to +6V	Continuous Power Dissipation (T _A = +70°C)	
IN_ on Side A, ENA, DEFA to GNDA.....	-0.3V to +6V	QSOP (derate 8.98mW/°C above +70°C).....	718.78mW
IN_ on Side B, ENB, DEFB to GNDB.....	-0.3V to +6V	Temperature Ratings	
OUT_ on Side A to GNDA.....	-0.3V to (V _{DDA} + 0.3V)	Operating Temperature Range.....	-40°C to +125°C
OUT_ on Side B to GNDB.....	-0.3V to (V _{ddb} + 0.3V)	Maximum Junction Temperature.....	+150°C
Short-Circuit Continuous Current		Storage Temperature Range.....	-60°C to +150°C
OUT_ on Side A to GNDA.....	±30mA	Lead Temperature (soldering, 10s).....	+300°C
		Soldering Temperature (reflow).....	+260°C

Stresses beyond those listed under “Absolute Maximum Ratings” may cause permanent damage to the device. These are stress ratings only, and functional operation of the device at these or any other conditions beyond those indicated in the operational sections of the specifications is not implied. Exposure to absolute maximum rating conditions for extended periods may affect device reliability.

Package Information

PACKAGE TYPE: 16 QSOP	
Package Code	E16MS+2
Outline Number	21-0055
Land Pattern Number	90-0167
THERMAL RESISTANCE, FOUR LAYER BOARD:	
Junction-to-Ambient (θ _{JA})	111.30°C/W
Junction-to-Case Thermal Resistance (θ _{JC})	57.50°C/W

Package thermal resistances were obtained using the method described in JEDEC specification JESD51-7, using a four-layer board. For detailed information on package thermal considerations, refer to www.maximintegrated.com/thermal-tutorial.

For the latest package outline information and land patterns (footprints), go to www.maximintegrated.com/packages. Note that a “+”, “#”, or “-” in the package code indicates RoHS status only. Package drawings may show a different suffix character, but the drawing pertains to the package regardless of RoHS status.

DC Electrical Characteristics

($V_{DDA} - V_{GNDA} = 1.71V$ to $5.5V$, $V_{DDB} - V_{GNDB} = 1.71V$ to $5.5V$, $C_L = 15pF$, $T_A = -40^\circ C$ to $+125^\circ C$, unless otherwise noted. Typical values are at $V_{DDA} - V_{GNDA} = 3.3V$, $V_{DDB} - V_{GNDB} = 3.3V$, $V_{GNDA} = V_{GNDB}$, $T_A = +25^\circ C$, unless otherwise noted.) (Notes 1, 3)

PARAMETER	SYMBOL	CONDITIONS	MIN	TYP	MAX	UNITS	
SUPPLY VOLTAGE							
Supply Voltage	V_{DDA}	Relative to GNDA	1.71		5.5	V	
	V_{DDB}	Relative to GNDB	1.71		5.5		
Undervoltage-Lockout Threshold	$V_{UVLO_}$	V_{DD} rising	1.5	1.6	1.66	V	
Undervoltage-Lockout Threshold Hysteresis	V_{UVLO_HYST}			45		mV	
MAX22163 SUPPLY CURRENT (Note 2)							
Side A Supply Current	I_{DDA}	500kHz square wave, $C_L = 0pF$	$V_{DDA} = 5V$		1.23	2.28	mA
			$V_{DDA} = 3.3V$		1.22	2.25	
			$V_{DDA} = 2.5V$		1.21	2.24	
			$V_{DDA} = 1.8V$		1.18	1.97	
		50MHz square wave, $C_L = 0pF$	$V_{DDA} = 5V$		7.83	10.26	
			$V_{DDA} = 3.3V$		6.47	8.71	
			$V_{DDA} = 2.5V$		5.90	8.03	
			$V_{DDA} = 1.8V$		5.35	7.10	
Side B Supply Current	I_{DDB}	500kHz square wave, $C_L = 0pF$	$V_{DDB} = 5V$		1.23	2.28	mA
			$V_{DDB} = 3.3V$		1.22	2.25	
			$V_{DDB} = 2.5V$		1.21	2.24	
			$V_{DDB} = 1.8V$		1.18	1.97	
		50MHz square wave, $C_L = 0pF$	$V_{DDB} = 5V$		7.83	10.26	
			$V_{DDB} = 3.3V$		6.47	8.71	
			$V_{DDB} = 2.5V$		5.90	8.03	
			$V_{DDB} = 1.8V$		5.35	7.10	
MAX22164 SUPPLY CURRENT (Note 2)							
Side A Supply Current	I_{DDA}	500kHz square wave, $C_L = 0pF$	$V_{DDA} = 5V$		1.09	2.01	mA
			$V_{DDA} = 3.3V$		1.07	1.99	
			$V_{DDA} = 2.5V$		1.06	1.98	
			$V_{DDA} = 1.8V$		1.04	1.66	
		50MHz square wave, $C_L = 0pF$	$V_{DDA} = 5V$		7.63	10.10	
			$V_{DDA} = 3.3V$		6.67	9.01	
			$V_{DDA} = 2.5V$		6.28	8.52	
			$V_{DDA} = 1.8V$		5.84	7.67	
Side B Supply Current	I_{DDB}	500kHz square wave, $C_L = 0pF$	$V_{DDB} = 5V$		1.38	2.55	mA
			$V_{DDB} = 3.3V$		1.36	2.52	
			$V_{DDB} = 2.5V$		1.35	2.51	
			$V_{DDB} = 1.8V$		1.32	2.28	
		50MHz square wave, $C_L = 0pF$	$V_{DDB} = 5V$		8.04	10.38	
			$V_{DDB} = 3.3V$		6.27	8.41	

($V_{DDA} - V_{GNDA} = 1.71V$ to $5.5V$, $V_{DDB} - V_{GNDB} = 1.71V$ to $5.5V$, $C_L = 15pF$, $T_A = -40^{\circ}C$ to $+125^{\circ}C$, unless otherwise noted. Typical values are at $V_{DDA} - V_{GNDA} = 3.3V$, $V_{DDB} - V_{GNDB} = 3.3V$, $V_{GNDA} = V_{GNDB}$, $T_A = +25^{\circ}C$, unless otherwise noted.) (Notes 1, 3)

PARAMETER	SYMBOL	CONDITIONS		MIN	TYP	MAX	UNITS
			$V_{DDB} = 2.5V$		5.54	7.53	
			$V_{DDB} = 1.8V$		4.87	6.53	
MAX22165 SUPPLY CURRENT (Note 2)							
Side A Supply Current	I_{DDA}	500kHz square wave, $C_L = 0pF$	$V_{DDA} = 5V$	0.94	1.74	mA	
			$V_{DDA} = 3.3V$	0.93	1.72		
			$V_{DDA} = 2.5V$	0.92	1.71		
			$V_{DDA} = 1.8V$	0.90	1.34		
		50MHz square wave, $C_L = 0pF$	$V_{DDA} = 5V$	7.44	9.96		
			$V_{DDA} = 3.3V$	6.88	9.31		
			$V_{DDA} = 2.5V$	6.64	9.03		
			$V_{DDA} = 1.8V$	6.32	8.23		
Side B Supply Current	I_{DDB}	500kHz square wave, $C_L = 0pF$	$V_{DDB} = 5V$	1.53	2.82	mA	
			$V_{DDB} = 3.3V$	1.50	2.79		
			$V_{DDB} = 2.5V$	1.50	2.78		
			$V_{DDB} = 1.8V$	1.45	2.59		
		50MHz square wave, $C_L = 0pF$	$V_{DDB} = 5V$	8.36	10.64		
			$V_{DDB} = 3.3V$	6.16	8.19		
			$V_{DDB} = 2.5V$	5.24	7.10		
			$V_{DDB} = 1.8V$	4.45	6.01		
MAX22166 SUPPLY CURRENT (Note 2)							
Side A Supply Current	I_{DDA}	500kHz square wave, $C_L = 0pF$	$V_{DDA} = 5V$	0.79	1.47	mA	
			$V_{DDA} = 3.3V$	0.78	1.45		
			$V_{DDA} = 2.5V$	0.78	1.44		
			$V_{DDA} = 1.8V$	0.75	1.02		
		50MHz square wave, $C_L = 0pF$	$V_{DDA} = 5V$	7.25	9.81		
			$V_{DDA} = 3.3V$	7.08	9.61		
			$V_{DDA} = 2.5V$	7.00	9.52		
			$V_{DDA} = 1.8V$	6.78	8.79		
Side B Supply Current	I_{DDB}	500kHz square wave, $C_L = 0pF$	$V_{DDB} = 5V$	1.67	3.09	mA	
			$V_{DDB} = 3.3V$	1.65	3.06		
			$V_{DDB} = 2.5V$	1.64	3.05		
			$V_{DDB} = 1.8V$	1.59	2.89		
		50MHz square wave, $C_L = 0pF$	$V_{DDB} = 5V$	8.57	10.81		
			$V_{DDB} = 3.3V$	5.97	7.91		
			$V_{DDB} = 2.5V$	4.89	6.62		
			$V_{DDB} = 1.8V$	3.97	5.44		
LOGIC INTERFACE (IN_, OUT_)							
Input High Voltage	V_{IH}	$2.25V \leq V_{DD_} \leq 5.5V$		$0.7 \times V_{DD_}$		V	

($V_{DDA} - V_{GNDA} = 1.71V$ to $5.5V$, $V_{DDB} - V_{GNDB} = 1.71V$ to $5.5V$, $C_L = 15pF$, $T_A = -40^\circ C$ to $+125^\circ C$, unless otherwise noted. Typical values are at $V_{DDA} - V_{GNDA} = 3.3V$, $V_{DDB} - V_{GNDB} = 3.3V$, $V_{GNDA} = V_{GNDB}$, $T_A = +25^\circ C$, unless otherwise noted.) (Notes 1, 3)

PARAMETER	SYMBOL	CONDITIONS	MIN	TYP	MAX	UNITS
Input Low Voltage	V_{IL}	$1.71V \leq V_{DD_} < 2.25V$	$0.75 \times V_{DD_}$			V
		$2.25V \leq V_{DD_} \leq 5.5V$	0.8			
		$1.71V \leq V_{DD_} < 2.25V$	0.7			
Input Hysteresis	V_{HYS}	MAX2216_B/E	410			mV
		MAX2216_C/F	80			
Input Pullup Current	I_{PU}	MAX2216_B/C	-10	-5	-1.5	μA
Input Pulldown Current	I_{PD}	MAX2216_E/F	1.5	5	10	μA
Input Capacitance	C_{IN}	$f_{SW} = 1MHz$	2			pF
Output Voltage High	V_{OH}	$I_{OUT} = -4mA$ source	$V_{DD_} - 0.4$			V
Output Voltage Low	V_{OL}	$I_{OUT} = 4mA$ sink	0.4			V

Dynamic Characteristics - MAX2216_C/F

($V_{DDA} - V_{GNDA} = 1.71V$ to $5.5V$, $V_{DDB} - V_{GNDB} = 1.71V$ to $5.5V$, $C_L = 15pF$, $T_A = -40^\circ C$ to $+125^\circ C$, unless otherwise noted. Typical values are at $V_{DDA} - V_{GNDA} = 3.3V$, $V_{DDB} - V_{GNDB} = 3.3V$, $V_{GNDA} = V_{GNDB}$, $T_A = +25^\circ C$, unless otherwise noted.) (Notes 2, 4)

PARAMETER	SYMBOL	CONDITIONS	MIN	TYP	MAX	UNITS	
Common-Mode Transient Immunity	CMTI	$IN_ = GND_$ or $V_{DD_}$ (Note 5)	50			kV/ μs	
Maximum Data Rate	DR_{MAX}	$2.25V \leq V_{DD_} \leq 5.5V$	200			Mbps	
		$1.71V \leq V_{DD_} < 2.25V$	150				
Minimum Pulse Width	PW_{MIN}	$IN_$ to $OUT_$	$2.25V \leq V_{DD_} \leq 5.5V$	5			ns
			$1.71V \leq V_{DD_} < 2.25V$	6.67			
Propagation Delay (Figure 1)	t_{PLH}	$IN_$ to $OUT_$, $C_L = 15pF$	$4.5V \leq V_{DD_} \leq 5.5V$	4.4	6.2	9.5	ns
Propagation Delay (Figure 1)	t_{PLH}	$IN_$ to $OUT_$, $C_L = 15pF$	$3.0V \leq V_{DD_} \leq 3.6V$	4.8	7.0	11.2	ns
			$2.25V \leq V_{DD_} \leq 2.75V$	5.3	8.3	14.7	
			$1.71V \leq V_{DD_} \leq 1.89V$	7.1	12.3	22.1	
	t_{PHL}	$IN_$ to $OUT_$, $C_L = 15pF$	$4.5V \leq V_{DD_} \leq 5.5V$	4.6	6.5	9.9	
			$3.0V \leq V_{DD_} \leq 3.6V$	5.0	7.3	11.6	
			$2.25V \leq V_{DD_} \leq 2.75V$	5.4	8.5	14.9	
Pulse Width Distortion	PWD	$ t_{PLH} - t_{PHL} $	$4.5V \leq V_{DD_} \leq 5.5V$	0.4		2.0	ns
			$3.0V \leq V_{DD_} \leq 3.6V$	0.4		2.0	
			$2.25V \leq V_{DD_} \leq 2.75V$	0.3		2.0	
			$1.71V \leq V_{DD_} \leq 1.89V$	0		2.0	
	t_{SPLH}	$4.5V \leq V_{DD_} \leq 5.5V$	3.7			ns	

($V_{DDA} - V_{GNDA} = 1.71V$ to $5.5V$, $V_{DDB} - V_{GNDB} = 1.71V$ to $5.5V$, $C_L = 15pF$, $T_A = -40^\circ C$ to $+125^\circ C$, unless otherwise noted. Typical values are at $V_{DDA} - V_{GNDA} = 3.3V$, $V_{DDB} - V_{GNDB} = 3.3V$, $V_{GNDA} = V_{GNDB}$, $T_A = +25^\circ C$, unless otherwise noted.) (Notes 2, 4)

PARAMETER	SYMBOL	CONDITIONS		MIN	TYP	MAX	UNITS
Propagation Delay Skew Part-to-Part (Same Channel)		$3.0V \leq V_{DD_} \leq 3.6V$				4.7	
		$2.25V \leq V_{DD_} \leq 2.75V$				6.9	
		$1.71V \leq V_{DD_} \leq 1.89V$				12.1	
	t_{SPHL}	$4.5V \leq V_{DD_} \leq 5.5V$				4.0	
		$3.0V \leq V_{DD_} \leq 3.6V$				4.9	
		$2.25V \leq V_{DD_} \leq 2.75V$				7.0	
		$1.71V \leq V_{DD_} \leq 1.89V$				11.8	
Propagation Delay Skew Channel-to-Channel (Same Direction) (Figure 1)	t_{SCSLH}	$1.71V \leq V_{DD_} \leq 5.5V$				2.0	ns
	t_{SCSHL}	$1.71V \leq V_{DD_} \leq 5.5V$				2.0	
Propagation Delay Skew Channel-to-Channel (Opposite Direction)	t_{SCOLH}	$4.5V \leq V_{DD_} \leq 5.5V$				3.7	ns
		$3.0V \leq V_{DD_} \leq 3.6V$				4.7	
		$2.25V \leq V_{DD_} \leq 2.75V$				6.9	
		$1.71V \leq V_{DD_} \leq 1.89V$				12.1	
	t_{SCOHL}	$4.5V \leq V_{DD_} \leq 5.5V$				4.0	
		$3.0V \leq V_{DD_} \leq 3.6V$				4.9	
		$2.25V \leq V_{DD_} \leq 2.75V$				7.0	
		$1.71V \leq V_{DD_} \leq 1.89V$				11.8	
Peak Eye Diagram Jitter	$t_{JIT(PK)}$	200Mbps			100		ps
Clock Jitter RMS	$t_{JCLK(RMS)}$	500kHz clock input, rising/falling edges			11.1		ps
Rise Time (Figure 1)	t_R	$C_L = 5pF$	$4.5V \leq V_{DD_} \leq 5.5V$			0.8	ns
			$3.0V \leq V_{DD_} \leq 3.6V$			1.1	
			$2.25V \leq V_{DD_} \leq 2.75V$			1.5	
			$1.71V \leq V_{DD_} \leq 1.89V$			2.4	
Fall Time (Figure 1)	t_F	$C_L = 5pF$	$4.5V \leq V_{DD_} \leq 5.5V$			1.0	ns
			$3.0V \leq V_{DD_} \leq 3.6V$			1.4	
			$2.25V \leq V_{DD_} \leq 2.75V$			1.9	
			$1.71V \leq V_{DD_} \leq 1.89V$			3.0	

Dynamic Characteristics - MAX2216_B/E

($V_{DDA} - V_{GNDA} = 1.71V$ to $5.5V$, $V_{DDB} - V_{GNDB} = 1.71V$ to $5.5V$, $C_L = 15pF$, $T_A = -40^\circ C$ to $+125^\circ C$, unless otherwise noted. Typical values are at $V_{DDA} - V_{GNDA} = 3.3V$, $V_{DDB} - V_{GNDB} = 3.3V$, $V_{GNDA} = V_{GNDB}$, $T_A = +25^\circ C$, unless otherwise noted.) (Notes 2, 4)

PARAMETER	SYMBOL	CONDITIONS	MIN	TYP	MAX	UNITS
Common-Mode Transient Immunity	CMTI	$IN_ = GND_$ or $V_{DD_}$ (Note 5)		50		kV/ μ s
Maximum Data Rate	DR_{MAX}		25			Mbps
Minimum Pulse Width	PW_{MIN}	$IN_$ to $OUT_$			40	ns
Glitch Rejection		$IN_$ to $OUT_$	10	17	29	ns

($V_{DDA} - V_{GNDA} = 1.71V$ to $5.5V$, $V_{DDB} - V_{GNDB} = 1.71V$ to $5.5V$, $C_L = 15pF$, $T_A = -40^\circ C$ to $+125^\circ C$, unless otherwise noted. Typical values are at $V_{DDA} - V_{GNDA} = 3.3V$, $V_{DDB} - V_{GNDB} = 3.3V$, $V_{GNDA} = V_{GNDB}$, $T_A = +25^\circ C$, unless otherwise noted.) (Notes 2, 4)

PARAMETER	SYMBOL	CONDITIONS		MIN	TYP	MAX	UNITS	
Propagation Delay (Figure 1)	t _{PLH}	IN ₋ to OUT ₋ , C _L = 15pF	4.5V ≤ V _{DD-} ≤ 5.5V	16.7	22.6	30.7	ns	
			3.0V ≤ V _{DD-} ≤ 3.6V	17.0	23.4	32.2		
			2.25V ≤ V _{DD-} ≤ 2.75V	17.7	24.8	35.3		
			1.71V ≤ V _{DD-} ≤ 1.89V	19.6	28.8	42.8		
	t _{PHL}	IN ₋ to OUT ₋ , C _L = 15pF	4.5V ≤ V _{DD-} ≤ 5.5V	16.4	22.7	32.1		
			3.0V ≤ V _{DD-} ≤ 3.6V	16.8	23.5	33.8		
			2.25V ≤ V _{DD-} ≤ 2.75V	17.3	24.8	36.7		
			1.71V ≤ V _{DD-} ≤ 1.89V	19.0	28.4	43.7		
Pulse Width Distortion	PWD	t _{PLH} - t _{PHL}	4.5V ≤ V _{DD-} ≤ 5.5V		0.2	4.0	ns	
			3.0V ≤ V _{DD-} ≤ 3.6V		0.2	4.0		
			2.25V ≤ V _{DD-} ≤ 2.75V		0.3	4.0		
			1.71V ≤ V _{DD-} ≤ 1.89V		0.6	4.0		
Propagation Delay Skew Part-to-Part (Same Channel)	t _{SPLH}		4.5V ≤ V _{DD-} ≤ 5.5V			14.0	ns	
			3.0V ≤ V _{DD-} ≤ 3.6V			13.8		
			2.25V ≤ V _{DD-} ≤ 2.75V			15.2		
			1.71V ≤ V _{DD-} ≤ 1.89V			21.9		
	t _{SPHL}			4.5V ≤ V _{DD-} ≤ 5.5V				13.0
				3.0V ≤ V _{DD-} ≤ 3.6V				13.5
				2.25V ≤ V _{DD-} ≤ 2.75V				15.4
				1.71V ≤ V _{DD-} ≤ 1.89V				21.4
Propagation Delay Skew Channel-to-Channel (Same Direction) (Figure 1)	t _{SCSLH}		1.71V ≤ V _{DD-} ≤ 5.5V			4.0	ns	
	t _{SCSHL}		1.71V ≤ V _{DD-} ≤ 5.5V			4.0		
Propagation Delay Skew Channel-to-Channel (Opposite Direction)	t _{SCOLH}		4.5V ≤ V _{DD-} ≤ 5.5V			14.0	ns	
			3.0V ≤ V _{DD-} ≤ 3.6V			13.8		
			2.25V ≤ V _{DD-} ≤ 2.75V			15.2		
			1.71V ≤ V _{DD-} ≤ 1.89V			21.9		
	t _{SCOHL}			4.5V ≤ V _{DD-} ≤ 5.5V				13.0
				3.0V ≤ V _{DD-} ≤ 3.6V				13.5
				2.25V ≤ V _{DD-} ≤ 2.75V				15.4
				1.71V ≤ V _{DD-} ≤ 1.89V				21.4
Peak Eye Diagram Jitter	t _{JIT(PK)}		25Mbps		250		ps	
Rise Time (Figure 1)	t _R	C _L = 5pF	4.5V ≤ V _{DD-} ≤ 5.5V			0.8	ns	
			3.0V ≤ V _{DD-} ≤ 3.6V			1.1		
			2.25V ≤ V _{DD-} ≤ 2.75V			1.5		

($V_{DDA} - V_{GNDA} = 1.71V$ to $5.5V$, $V_{DDB} - V_{GNDB} = 1.71V$ to $5.5V$, $C_L = 15pF$, $T_A = -40^{\circ}C$ to $+125^{\circ}C$, unless otherwise noted. Typical values are at $V_{DDA} - V_{GNDA} = 3.3V$, $V_{DDB} - V_{GNDB} = 3.3V$, $V_{GNDA} = V_{GNDB}$, $T_A = +25^{\circ}C$, unless otherwise noted.) (Notes 2, 4)

PARAMETER	SYMBOL	CONDITIONS		MIN	TYP	MAX	UNITS
Fall Time (Figure 1)	t_F	$C_L = 5pF$	$1.71V \leq V_{DD_} \leq 1.89V$			2.4	ns
			$4.5V \leq V_{DD_} \leq 5.5V$			1.0	
			$3.0V \leq V_{DD_} \leq 3.6V$			1.4	
			$2.25V \leq V_{DD_} \leq 2.75V$			1.9	
			$1.71V \leq V_{DD_} \leq 1.89V$			3.0	

Note 1: General purpose devices are 100% production tested at $T_A = +25^{\circ}C$. Specifications over temperature are guaranteed by design and characterization. Automotive devices are 100% production tested at $T_A = +25^{\circ}C$ and $T_A = +125^{\circ}C$.

Note 2: Not production tested. Guaranteed by design and characterization.

Note 3: All currents into the device are positive. All currents out of the device are negative. All voltages are referenced to their respective grounds (GNDA or GNDB), unless otherwise noted.

Note 4: All measurements are taken with $V_{DDA} = V_{DDB}$, unless otherwise noted.

Note 5: CMTI is the maximum sustainable common-mode voltage slew rate while maintaining the correct output. CMTI applies to both rising and falling common-mode voltage edges. Tested with the transient generator connected between GNDA and GNDB ($V_{CM} = 1000V$).

ESD Protection

PARAMETER	SYMBOL	CONDITIONS	VALUE	UNITS
ESD		Human Body Model, All Pins	± 4	kV
		IEC 61000-4-2 Contact, GNDB to GNDA	± 6	kV

Test Circuit and Timing Diagram

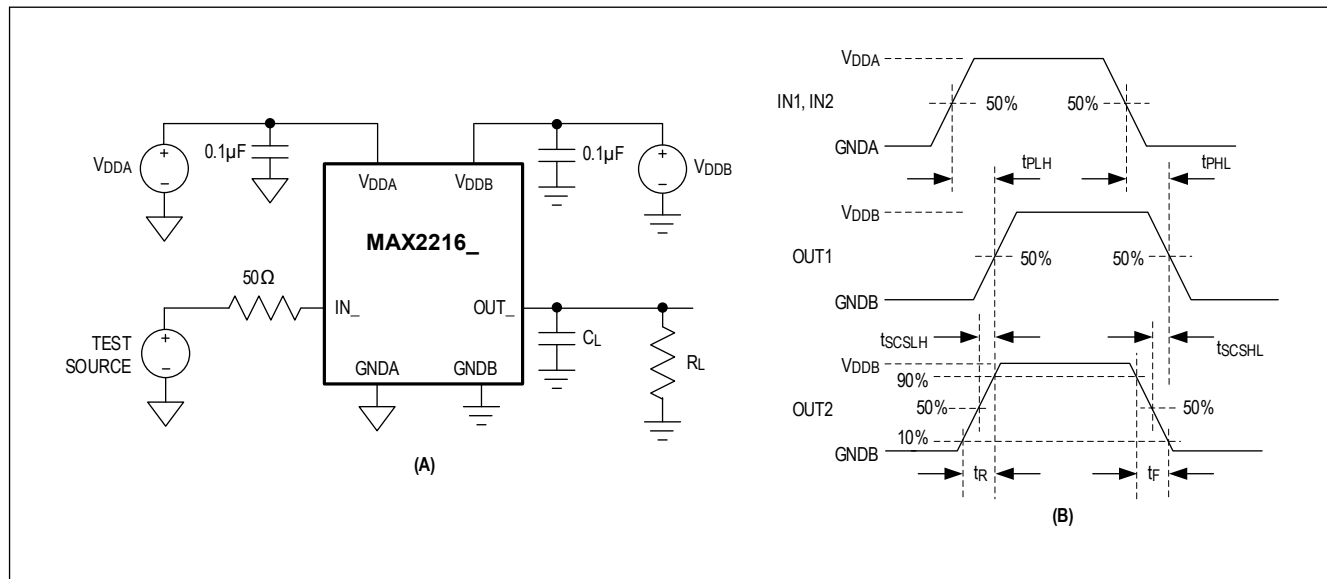

Figure 1. Test Circuit (A) and Timing Diagram (B)

Table 1. Insulation Characteristics

PARAMETER	SYMBOL	CONDITIONS	VALUE	UNITS
Partial Discharge Test Voltage	V_{PR}	Method B1 = $V_{IORM} \times 1.875$ ($t = 1s$, partial discharge < 5pC)	1182	V_P
Maximum Repetitive Peak Isolation Voltage	V_{IORM}	(Note 6)	630	V_P
Maximum Working Isolation Voltage	V_{IOWM}	Continuous RMS voltage (Note 6)	445	V_{RMS}
Maximum Transient Isolation Voltage	V_{IOTM}	$t = 1s$ (Note 6)	4242	V_P
Maximum Withstanding Isolation Voltage	V_{ISO}	$f_{SW} = 60Hz$, duration = 60s (Notes 6, 7)	3000	V_{RMS}
Maximum Surge Isolation Voltage	V_{IOSM}	Reinforced Insulation, test method per IEC 60065, $V_{TEST} = 1.6 \times V_{IOSM} = 10,000V_{PEAK}$ (Notes 6, 9)	6250	V_P
Isolation Resistance	R_{IO}	$V_{IO} = 500V$, $T_A = 25^\circ C$	$>10^{12}$	Ω
		$V_{IO} = 500V$, $100^\circ C \leq T_A \leq 125^\circ C$	$>10^{11}$	
		$V_{IO} = 500V$, $T_S = 150^\circ C$	$>10^9$	
Barrier Capacitance Side A to Side B	C_{IO}	$f_{SW} = 1MHz$ (Note 8)	1.5	pF
Minimum Creepage Distance	CPG		4	mm
Minimum Clearance Distance	CLR		4	mm
Internal Clearance		Distance through insulation	0.021	mm
Comparative Tracking Index	CTI	Material Group II (IEC 60112)	>400	
Climate Category			40/125/21	
Pollution Degree (DIN VDE 0110, Table 1)			2	

Note 6: V_{ISO} , V_{IOWM} , V_{IOTM} , V_{IORM} , and V_{IOSM} are defined by the IEC 60747-5-5 standard.

Note 7: Product is qualified at V_{ISO} for 60s and 100% production tested at 120% of V_{ISO} for 1s.

Note 8: Capacitance is measured with all pins on the A and B sides tied together.

Note 9: Devices are immersed in oil during surge characterization.

Safety Regulatory Approvals

UL
The MAX22163–MAX22166 are certified under UL1577. For more details, refer to file E351759.
Rated up to 3000 V_{RMS} isolation voltage for single protection.
cUL (Equivalent to CSA notice 5A)
The MAX22163–MAX22166 are certified up to 3000 V_{RMS} for single protection. For more details, refer to file E351759.
VDE (Pending)
The MAX22163–MAX22166 are certified to DIN VDE V 0884-11: 2017-1. Reinforced Insulation, Maximum Transient Isolation Voltage 4242 V_{PK} , Maximum Repetitive Peak Isolation Voltage 630 V_{PK} .

These couplers are suitable for "safe electrical insulation" only within the safety ratings. Compliance with the safety ratings shall be ensured by means of suitable protective circuits.

Typical Operating Characteristics

($V_{DDA} - V_{GNDA} = +3.3V$, $V_{DDB} - V_{GNDB} = +3.3V$, $V_{GNDA} = V_{GNDB}$, $T_A = +25^\circ C$, unless otherwise noted.)

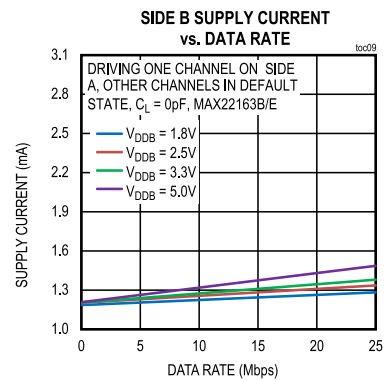
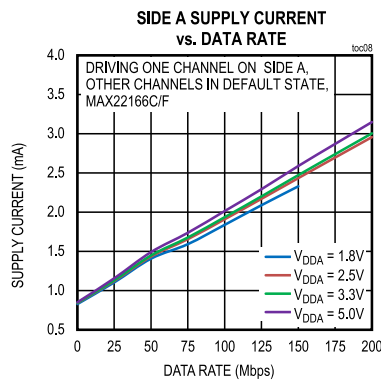
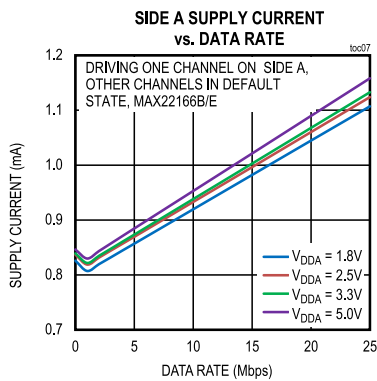
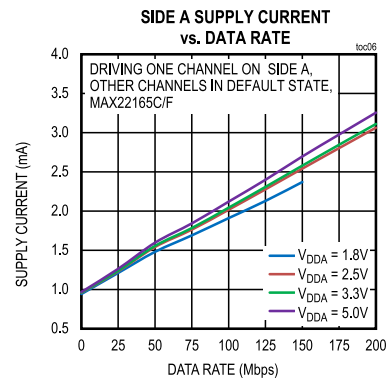
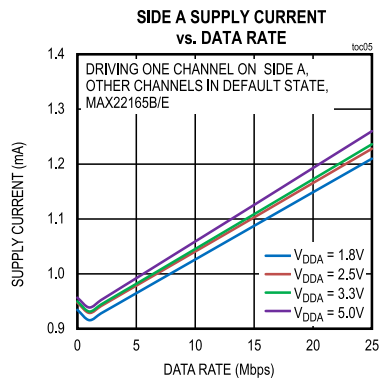
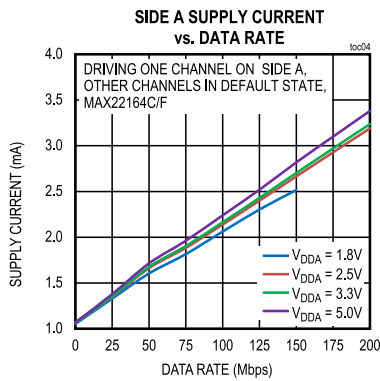
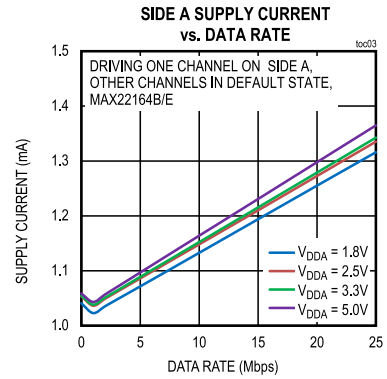
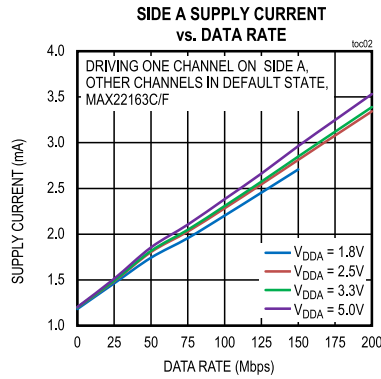
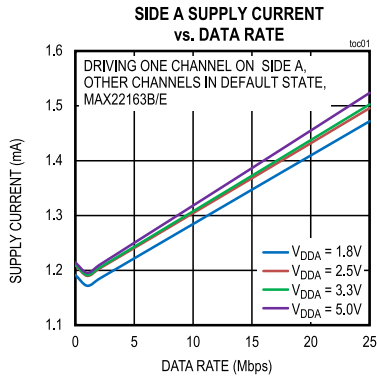

($V_{DDA} - V_{GNDA} = +3.3V$, $V_{DDB} - V_{GNDB} = +3.3V$, $V_{GNDA} = V_{GNDB}$, $T_A = +25^\circ C$, unless otherwise noted.)

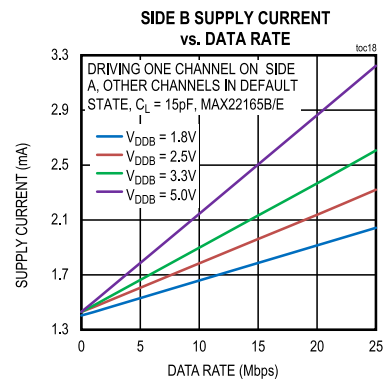
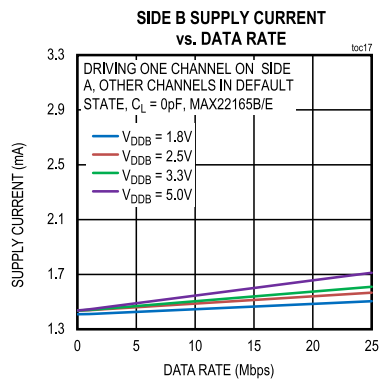
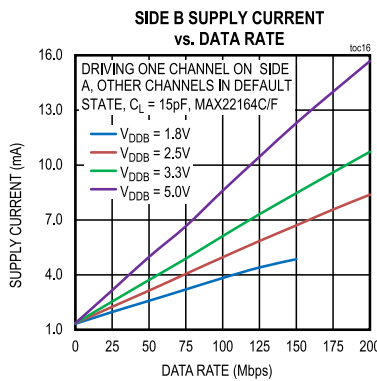
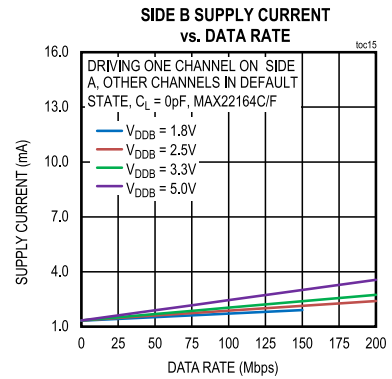
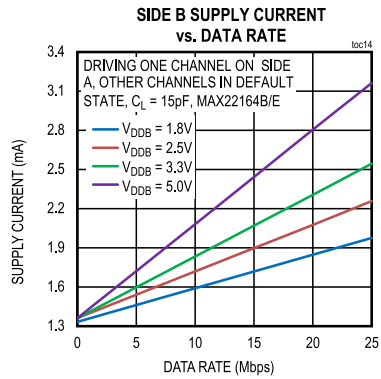
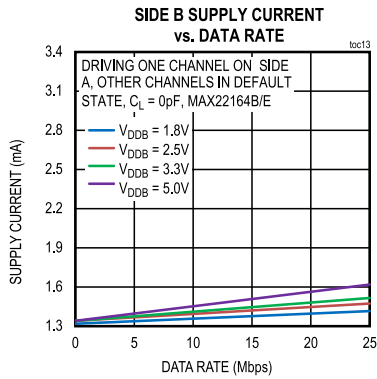
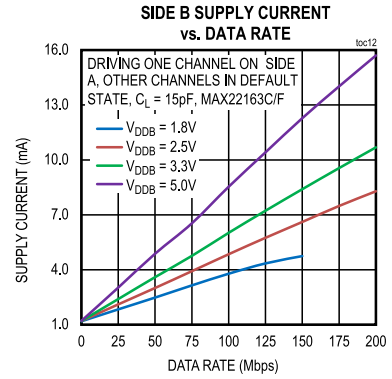
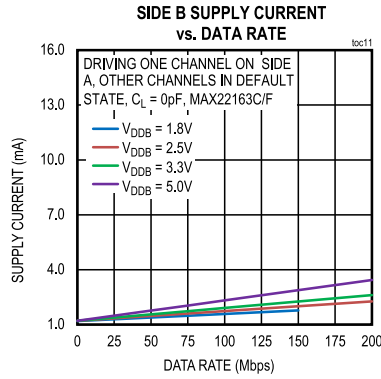
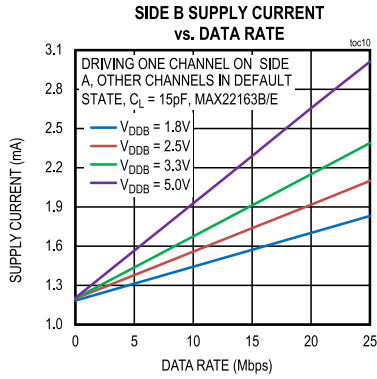

($V_{DDA} - V_{GNDA} = +3.3V$, $V_{DDB} - V_{GNDB} = +3.3V$, $V_{GNDA} = V_{GNDB}$, $T_A = +25^\circ C$, unless otherwise noted.)

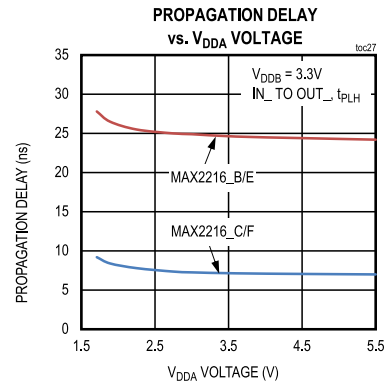
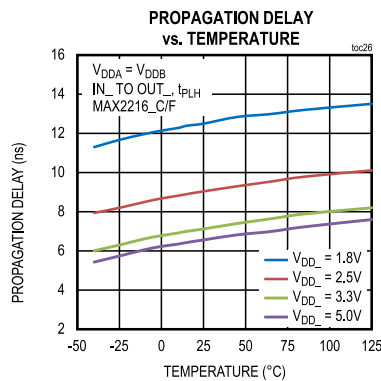
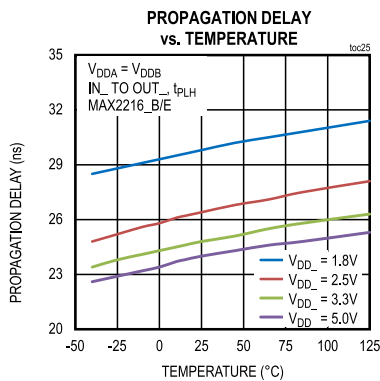
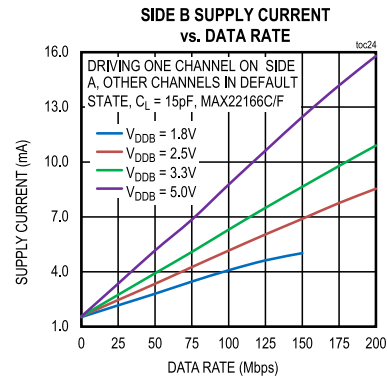
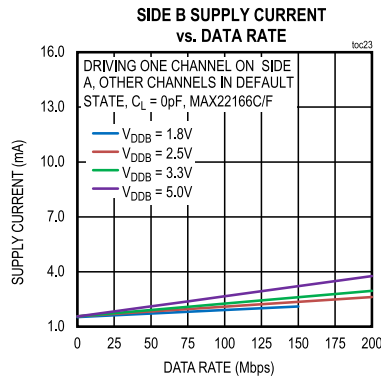
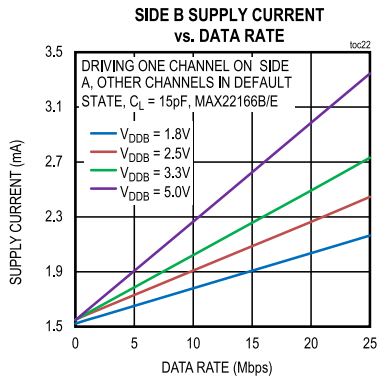
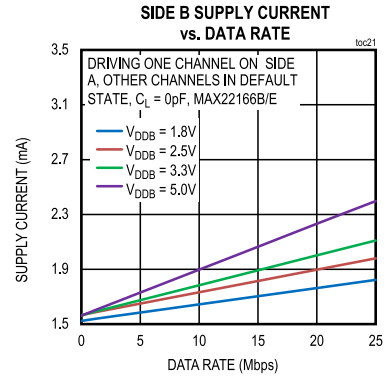
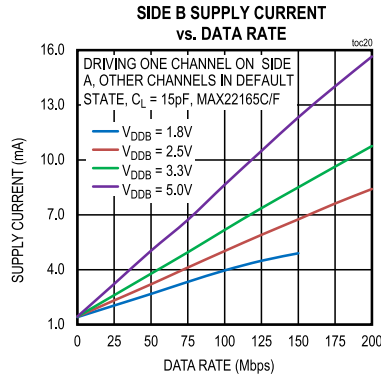
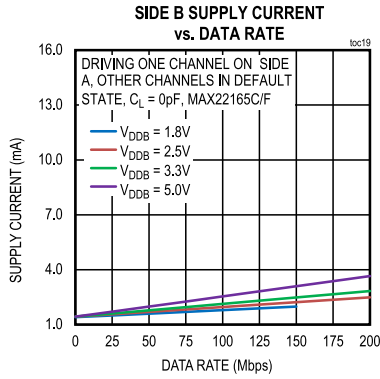

($V_{DDA} - V_{GNDA} = +3.3V$, $V_{DDB} - V_{GNDB} = +3.3V$, $V_{GNDA} = V_{GNDB}$, $T_A = +25^\circ C$, unless otherwise noted.)

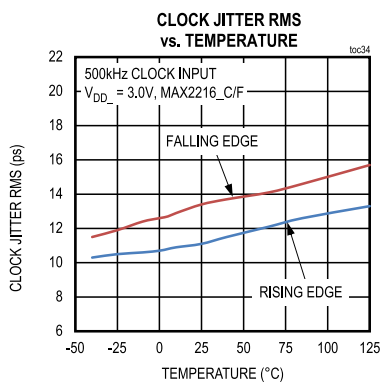
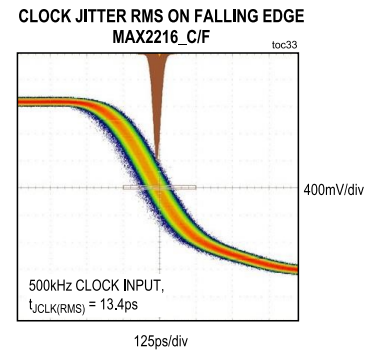
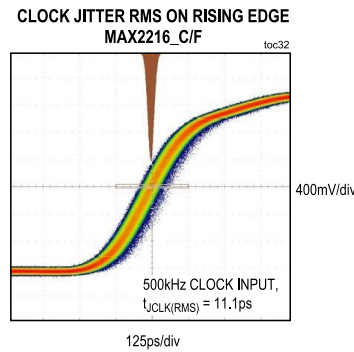
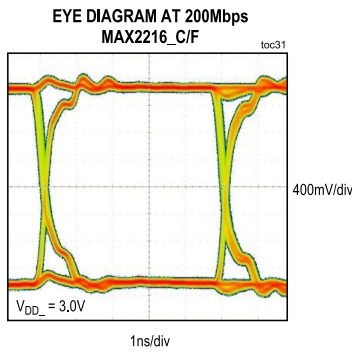
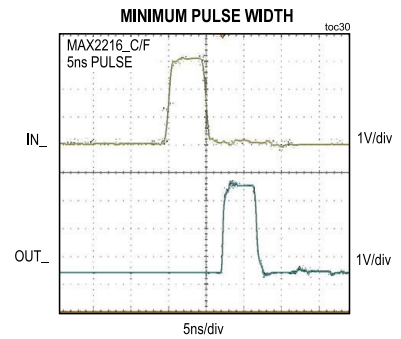
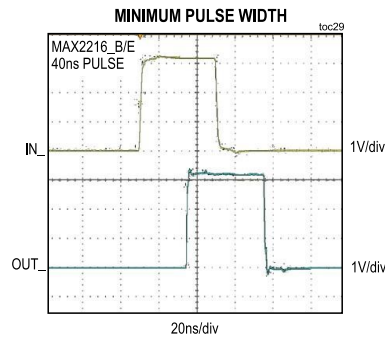
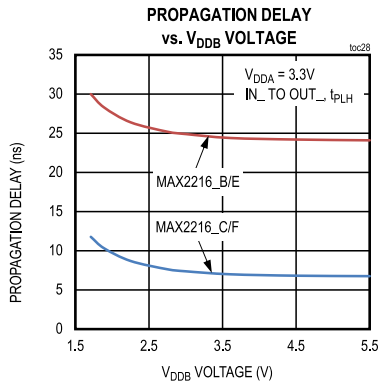

Pin Configurations

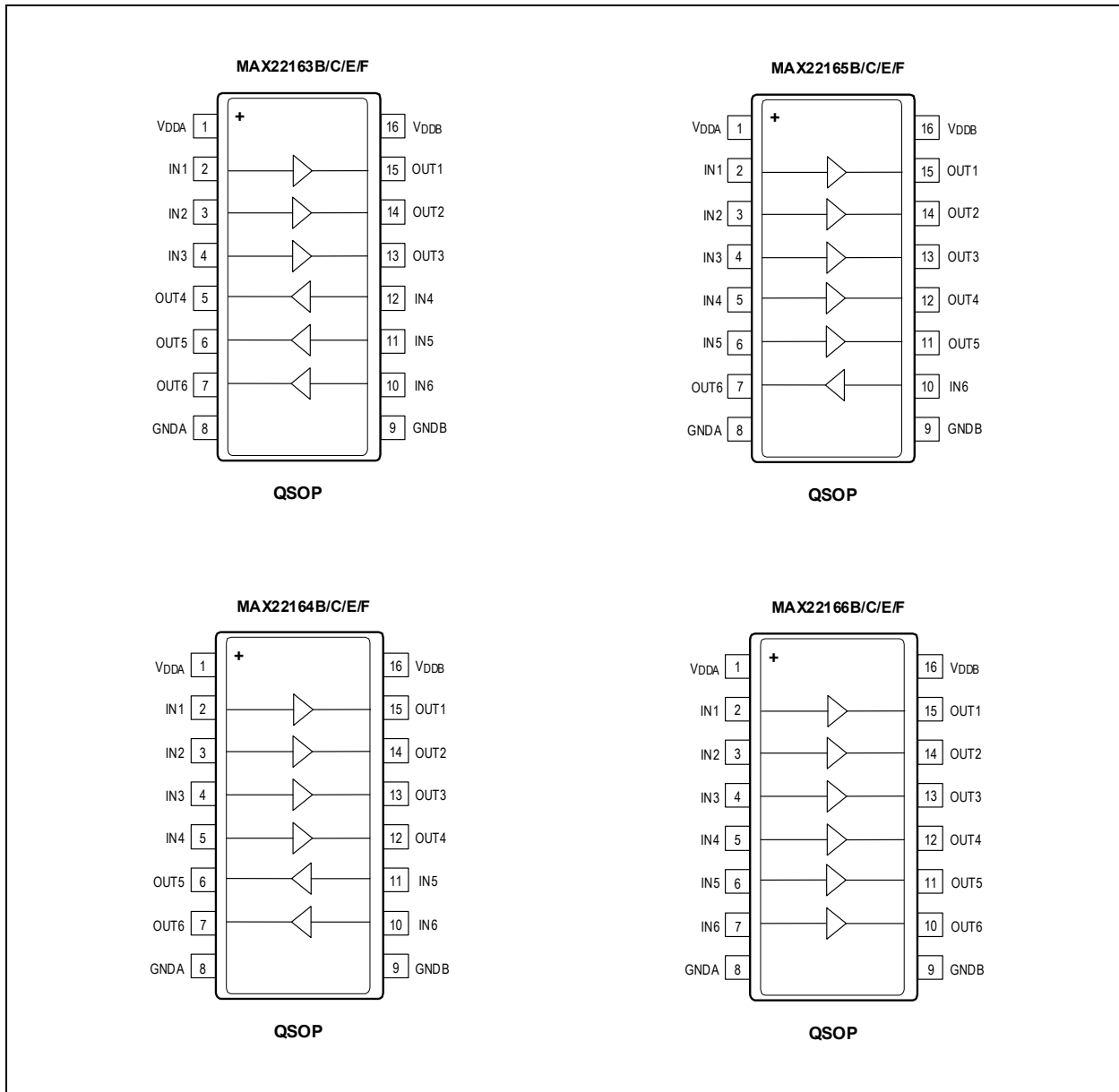

Pin Descriptions

PIN				NAME	FUNCTION
MAX22163	MAX22164	MAX22165	MAX22166		
1	1	1	1	V _{DDA}	Power Supply Input for Side A. Bypass V _{DDA} to GNDA with a 0.1µF ceramic capacitor as close as possible to the pin.
2	2	2	2	IN1	Logic Input 1 on Side A. Corresponds to Logic Output 1 on Side B.
3	3	3	3	IN2	Logic Input 2 on Side A. Corresponds to Logic Output 2 on Side B.
4	4	4	4	IN3	Logic Input 3 on Side A. Corresponds to Logic Output 3 on Side B.
12	5	5	5	IN4	Logic Input 4 on Side A/B. Corresponds to Logic Output 4 on Side B/A.
11	11	6	6	IN5	Logic Input 5 on Side A/B. Corresponds to Logic Output 5 on Side B/A.
10	10	10	7	IN6	Logic Input 6 on Side A/B. Corresponds to Logic Output 6 on Side B/A.
8	8	8	8	GNDA	Ground Reference for Side A.
9	9	9	9	GNDB	Ground Reference for Side B.
7	7	7	10	OUT6	Logic Output 6 on Side B/A. OUT6 is the logic output for the IN6 input on Side A/B.
6	6	11	11	OUT5	Logic Output 5 on Side B/A. OUT5 is the logic output for the IN5 input on Side A/B.
5	12	12	12	OUT4	Logic Output 4 on Side B/A. OUT4 is the logic output for the IN4 input on Side A/B.
13	13	13	13	OUT3	Logic Output 3 on Side B. OUT3 is the logic output for the IN3 input on Side A.
14	14	14	14	OUT2	Logic Output 2 on Side B. OUT2 is the logic output for the IN2 input on Side A.
15	15	15	15	OUT1	Logic Output 1 on Side B. OUT1 is the logic output for the IN1 input on Side A.
16	16	16	16	V _{ddb}	Power Supply Input for Side B. Bypass V _{ddb} to GNDB with a 0.1µF ceramic capacitor as close as possible to the pin.

Functional Diagrams

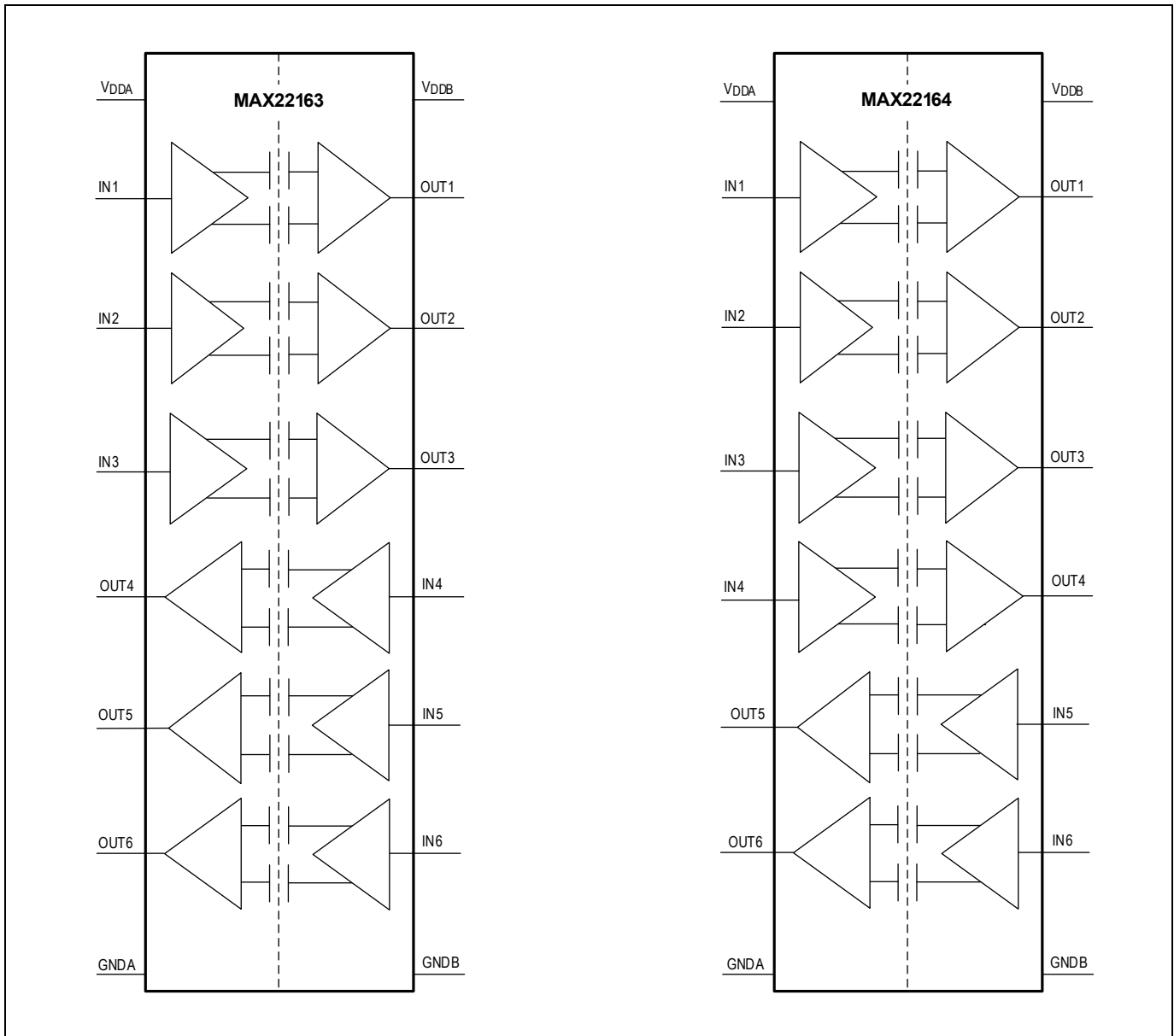

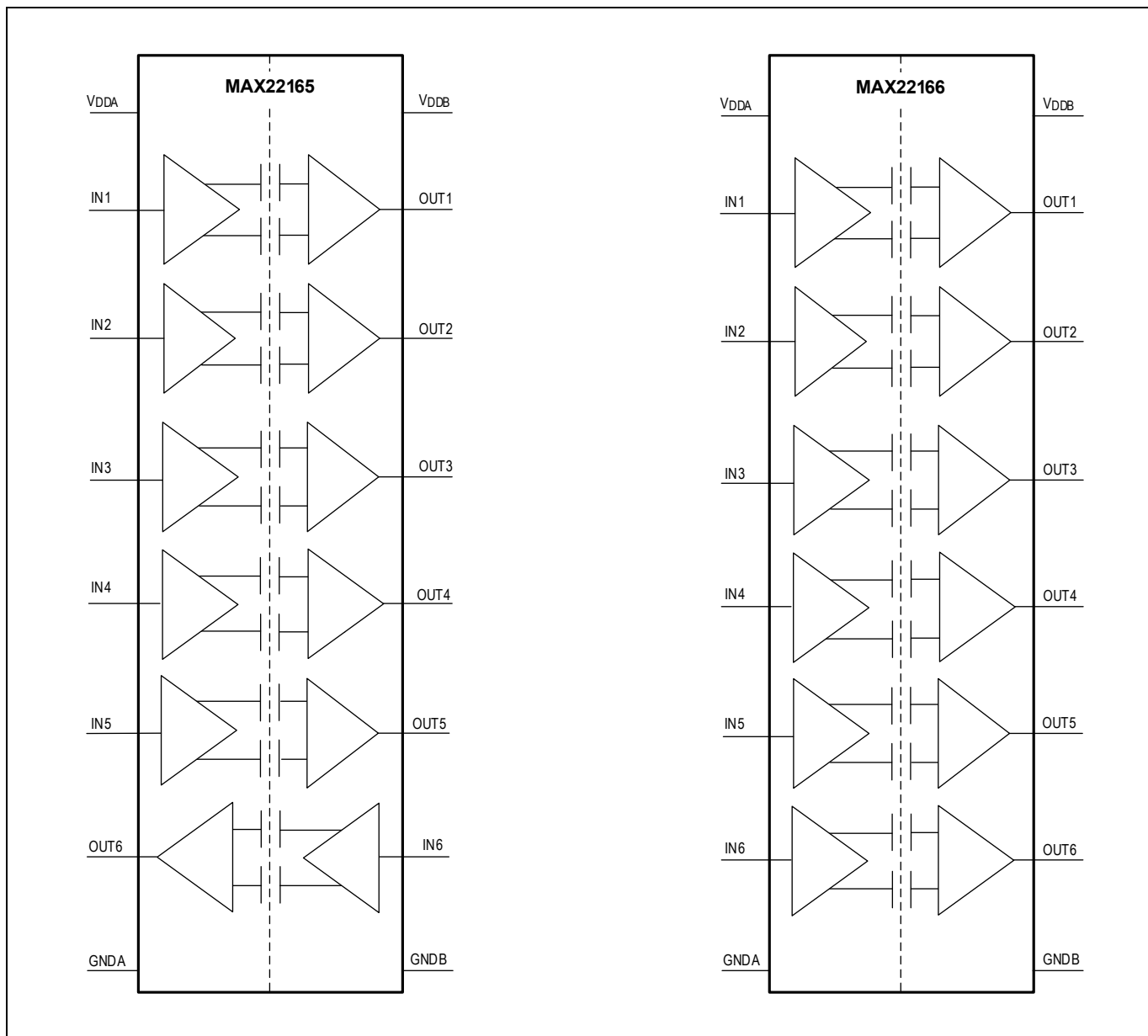

Detailed Description

The MAX22163–MAX22166 are a family of six-channel reinforced digital isolators in a 16-QSOP package, with an isolation rating of $3kV_{RMS}$. This family of devices offers all possible unidirectional channel configurations to accommodate any six-channel design.

The MAX22163 features three channels transmitting digital signals in one direction and three channels transmitting in the opposite direction for applications such as isolated microcontroller interfaces. The MAX22164 offers four channels transmitting digital signals in one direction and two channels transmitting in the opposite direction, making them ideal for applications such as isolated SPI. The MAX22165 provides five channels transmitting digital signals in one direction and one channel transmitting in the opposite direction. The MAX22166 features all six channels transmitting digital signals in one direction, which are suitable in applications such as isolated digital I/O.

The MAX22163–MAX22166 are available in a 16-pin QSOP package with 4mm creepage and clearance, with an isolation rating of $3kV_{RMS}$. This family of digital isolators offers low-power operation, high electromagnetic interference (EMI) immunity, and stable temperature performance through Analog Devices' proprietary process technology. The devices isolate different ground domains and block high-voltage/high-current transients from sensitive or human interface circuitry.

Devices are available with a maximum data rate of either 25Mbps (B/E version) or 200Mbps (C/F version). The MAX2216_B/C feature default-high outputs. The MAX2216_E/F feature default-low outputs. The output assumes the default state when the input is not powered or if the input is open-circuit. The MAX22163–MAX22166 have two supply inputs (V_{DDA} and V_{DDB}) that independently set the logic levels on either side of the device. V_{DDA} and V_{DDB} are referenced to $GNDA$ and $GNDB$, respectively. The MAX22163–MAX22166 also feature a refresh circuit to ensure output accuracy when an input remains in the same state indefinitely.

Digital Isolation

The family of devices provides reinforced galvanic isolation for digital signals transmitted between two ground domains. The MAX22163–MAX22166 can withstand differences of up to $3kV_{RMS}$ for up to 60 seconds, and up to $630V_{PEAK}$ of continuous isolation.

AEC-Q100 Qualification

Devices with /V suffix are AEC-Q100 qualified. See the [Ordering Information](#) table for all automotive grade part numbers.

Level Shifting

The wide supply voltage range of both V_{DDA} and V_{DDB} allows the MAX22163–MAX22166 to be used for level translation in addition to isolation. V_{DDA} and V_{DDB} can be independently set to any voltage from 1.71V to 5.5V. The supply voltage sets the logic level on the corresponding side of the isolator.

Unidirectional Channels

Each channel of the device is unidirectional; it only passes data in one direction, as indicated in the [Functional Diagrams](#). All devices feature six unidirectional channels that operate independently with guaranteed data rates from DC to 25Mbps (B/E version), or from DC to 200Mbps (C/F version). The output driver of each channel is push-pull, eliminating the need for pullup resistors. The outputs are able to drive both TTL and CMOS logic inputs.

Startup and Undervoltage Lockout

The V_{DDA} and V_{DDB} supplies are both internally monitored for undervoltage conditions. Undervoltage events can occur during power-up, power-down, or normal operation due to a sagging supply voltage. When an undervoltage condition is detected on either supply, all outputs go to their default states regardless of the state of the inputs, as seen in [Table 2](#). [Figure 2](#) through [Figure 5](#) show the behavior of the outputs during power-up and power-down.

Table 2. Output Behavior During Undervoltage Conditions

V _{IN}	V _{DDA}	V _{DDB}	V _{OUTA}	V _{OUTB}
1	Powered	Powered	High	High
0	Powered	Powered	Low	Low
X	Undervoltage	Powered	Default	Default
X	Powered	Undervoltage	Default	Default

Note: 'X' is don't care.

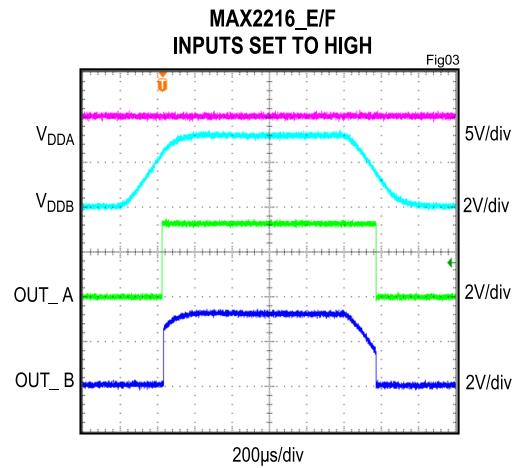
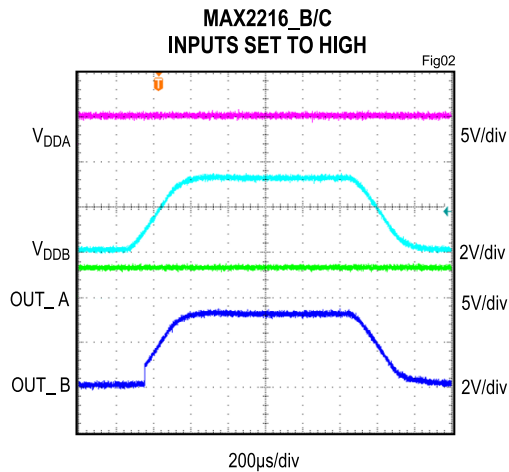

Figure 2. Undervoltage Lockout Behavior, MAX2216_B/C, Inputs Set to High

Figure 3. Undervoltage Lockout Behavior, MAX2216_E/F, Inputs Set to High

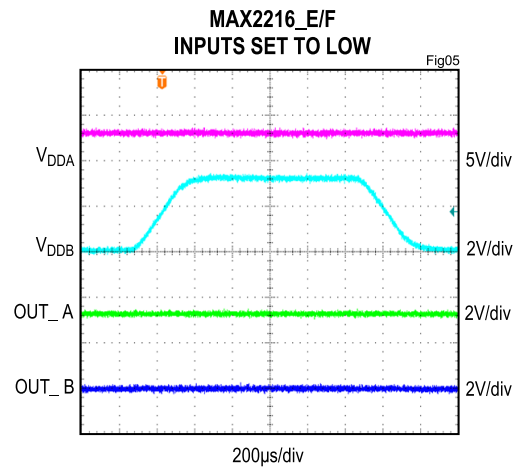
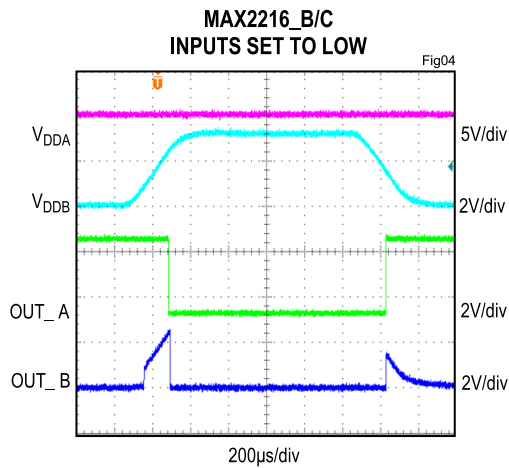

Figure 4. Undervoltage Lockout Behavior, MAX2216_B/C, Inputs Set to Low

Figure 5. Undervoltage Lockout Behavior, MAX2216_E/F, Inputs Set to Low

Safety Limit

Damage to the IC can result in a low-resistance path to ground or to the supply and, without current limiting, the MAX22163–MAX22166 can dissipate excessive amounts of power. Excessive power dissipation can damage the die and thus the isolation barrier, potentially causing downstream issues. [Table 3](#) shows the safety limits for the MAX22163–MAX22166.

The maximum safety temperature (T_S) for the device is the 150°C maximum junction temperature specified in the [Absolute Maximum Ratings](#). The power dissipation (P_D) and junction-to-ambient thermal impedance (θ_{JA}) determine the junction temperature. Thermal impedance values (θ_{JA} and θ_{JC}) are available in the [Package Information](#) section and power dissipation calculations are discussed in the [Calculating Power Dissipation](#) section. Calculate the junction temperature (T_J) as:

$$T_J = T_A + (P_D \times \theta_{JA})$$

[Figure 6](#) shows the thermal derating curve for safety limiting the power of the devices, and [Figure 7](#) shows the thermal derating curve for safety limiting the current of the devices. Ensure the junction temperature does not exceed 150°C.

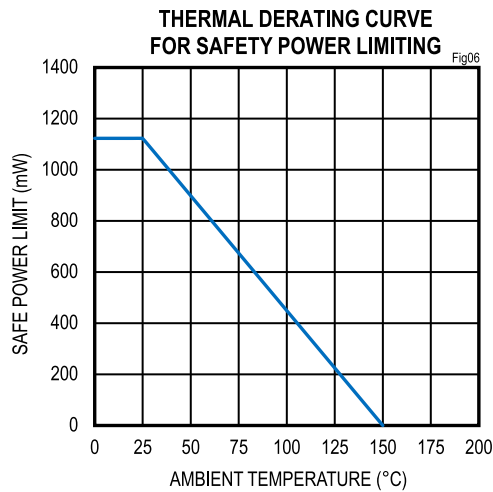

Figure 6. Thermal Derating Curve for Safety Power Limiting

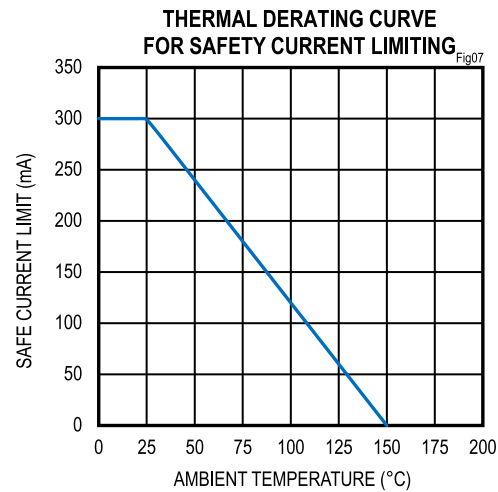

Figure 7. Thermal Derating Curve for Safety Current Limiting

Table 3. Safety Limiting Values

PARAMETER	SYMBOL	TEST CONDITIONS	MAX	UNIT
Safety Current on Any Pin (No Damage to Isolation Barrier)	I_S	$T_J = 150^\circ\text{C}$, $T_A = 25^\circ\text{C}$	300	mA
Total Safety Power Dissipation	P_S	$T_J = 150^\circ\text{C}$, $T_A = 25^\circ\text{C}$	1123	mW
Maximum Safety Temperature	T_S		150	°C

Applications Information

Power-Supply Sequencing

The MAX22163–MAX22166 do not require any special power supply sequencing. The logic levels are set independently on either side by V_{DDA} and V_{DDB} . Each supply can be present over the entire specified range regardless of the level or presence of the other supply.

Power-Supply Decoupling

To reduce ripple and the chance of introducing data errors, bypass V_{DDA} and V_{DDB} with 0.1 μ F low-ESR ceramic capacitors to GNDA and GNDB, respectively. Place the bypass capacitors as close to the power supply input pins as possible.

Layout Considerations

The PCB designer should follow some critical recommendations to get the best performance from the design.

- Keep the input/output traces as short as possible. To keep signal paths low-inductance, avoid using vias.
- Have a solid ground plane underneath the high-speed signal layer.
- Keep the area underneath the devices free from ground and signal planes. Any galvanic or metallic connection between Side A and Side B defeats the isolation.

Calculating Power Dissipation

The required current for a given supply (V_{DDA} or V_{DDB}) can be estimated by summing the current required for each channel. The supply current for a channel depends on if the channel is an input or an output, the channel's data rate, and the capacitive or resistive load if it is an output. The typical current for an input or output at any data rate can be estimated from the graphs in [Figure 8](#) and [Figure 9](#). Note that the data in [Figure 8](#) and [Figure 9](#) are extrapolated from the supply current measurements in a typical operating condition.

The total current for a single channel is the sum of the no load current (shown in [Figure 8](#) and [Figure 9](#)), which is a function of voltage and data rate, and the load current, which depends on the type of load. Current into a capacitive load is a function of the load capacitance, switching frequency, and supply voltage.

$$I_{CL} = C_L \times f_{SW} \times V_{DD}$$

where:

I_{CL} is the current required to drive the capacitive load.

C_L is the load capacitance on the isolator's output pin.

f_{SW} is the switching frequency (bits per second/2).

V_{DD} is the supply voltage on the output side of the isolator.

Current into a resistive load depends on the load resistance, supply voltage, and average duty cycle of the data waveform. The DC load current can be conservatively estimated by assuming the output is always high.

$$I_{RL} = V_{DD} \div R_L$$

where:

I_{RL} is the current required to drive the resistive load.

V_{DD} is the supply voltage on the output side of the isolator.

R_L is the load resistance on the isolator's output pin.

Example (shown in [Figure 10](#)): A MAX22164C is operating with $V_{DDA} = 2.5V$, $V_{DDB} = 3.3V$, channel 1 operating at 20Mbps with a 15k Ω resistive load; channel 2 operating at 100Mbps with a 10pF capacitive load; channel 3 is not in use and the resistive load is negligible as the isolator is driving a CMOS input; channel 4 held high with a 10k Ω resistive load; channel 5 operating at 50Mbps with a 20k Ω resistive load; and channel 6 operating at 200Mbps with a 15pF capacitive load. See [Table 4](#) and [Table 5](#) for V_{DDA} and V_{DDB} supply current calculation worksheets.

V_{DDA} must supply (with V_{DDA} = 2.5V):

- Channel 1 is an input channel operating at 2.5V and 20Mbps, consuming 0.35mA, estimated from [Figure 8](#).
- Channel 2 is an input channel operating at 2.5V and 100Mbps, consuming 1.19mA, estimated from [Figure 8](#).
- Channels 3 and 4 are input channels operating at 2.5V with DC signal, consuming 0.14mA, estimated from [Figure 8](#).
- Channel 5 is an output channel operating at 2.5V and 50Mbps, consuming 0.52mA, estimated from [Figure 9](#).
- I_{RL} on channel 5 for 20kΩ resistive load at 2.5V and switching at 50Mbps with 50% duty cycle is 0.0625mA.
- Channel 6 is an output channel operating at 2.5V and 200Mbps, consuming 1.31mA, estimated from [Figure 9](#).
- I_{CL} on channel 6 for 15pF capacitive load at 2.5V and 200Mbps is 3.75mA.

Total current for Side A = 7.46mA (typ).

V_{DDB} must supply (with V_{DDB} = 3.3V):

- Channel 1 is an output channel operating at 3.3V and 20Mbps, consuming 0.40mA, estimated from [Figure 9](#).
- I_{RL} on channel 1 for 15kΩ resistive load at 3.3V and switching at 20Mbps with 50% duty cycle is 0.11mA.
- Channel 2 is an output channel operating at 3.3V and 100Mbps, consuming 0.96mA, estimated from [Figure 9](#).
- I_{CL} on channel 2 for 10pF capacitive load at 3.3V and 100Mbps is 1.65mA.
- Channels 3 and 4 are output channels operating at 3.3V with DC signal, consuming 0.26mA, estimated from [Figure 9](#).
- I_{RL} on channel 4 for 10kΩ resistive load held at 3.3V is 0.33mA.
- Channel 5 is an input channel operating at 3.3V and 50Mbps, consuming 0.68mA, estimated from [Figure 8](#).
- Channel 6 is an input channel operating at 3.3V and 200Mbps, consuming 2.29mA, estimated from [Figure 8](#).

Total current for Side B = 6.94mA (typ).

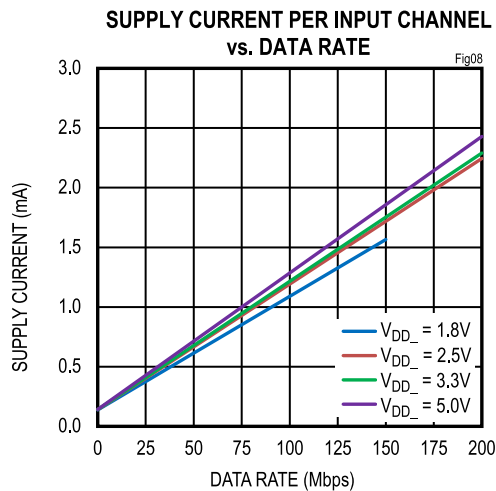

Figure 8. Supply Current Per Input Channel (Calculated)

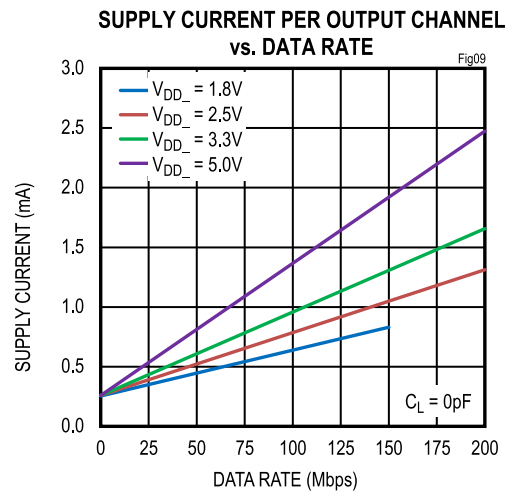

Figure 9. Supply Current Per Output Channel (Calculated)

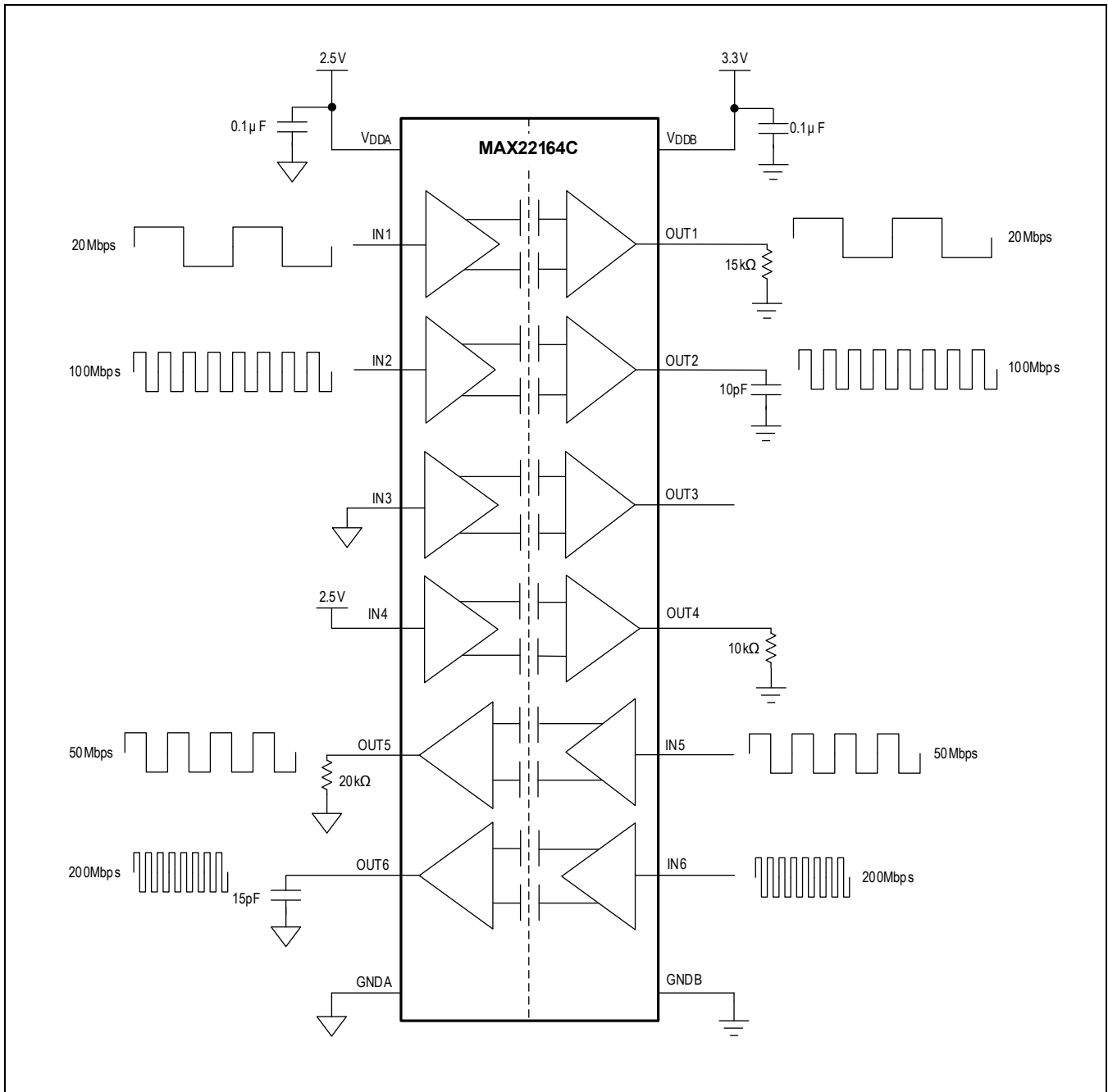

Figure 10. Example Circuit for Supply Current Calculation

Table 4. Side A Supply Current Calculation Worksheet

SIDE A		V _{DDA} = 2.5V				
CHANNEL	IN/OUT	DATA RATE (Mbps)	LOAD TYPE	LOAD	“NO LOAD” CURRENT (mA)	LOAD CURRENT (mA)
1	IN	20			0.35	
2	IN	100			1.19	
3	IN	0			0.14	
4	IN	0			0.14	
5	OUT	50	Resistive	20kΩ	0.52	$2.5V / 20k\Omega \times 0.5 = 0.0625mA$
6	OUT	200	Capacitive	15pF	1.31	$2.5V \times 100MHz \times 15pF = 3.75mA$
Total: 7.46mA						

Table 5. Side B Supply Current Calculation Worksheet

SIDE B		V _{ddb} = 3.3V				
CHANNEL	IN/OUT	DATA RATE (Mbps)	LOAD TYPE	LOAD	“NO LOAD” CURRENT (mA)	LOAD CURRENT (mA)
1	OUT	20	Resistive	15kΩ	0.40	$3.3V / 15k\Omega \times 0.5 = 0.11mA$
2	OUT	100	Capacitive	10pF	0.96	$3.3V \times 50MHz \times 10pF = 1.65mA$
3	OUT	0			0.26	
4	OUT	0	Resistive	10kΩ	0.26	$3.3V / 10k\Omega = 0.33mA$
5	IN	50			0.68	
6	IN	200			2.29	
Total: 6.94mA						

Typical Application Circuits

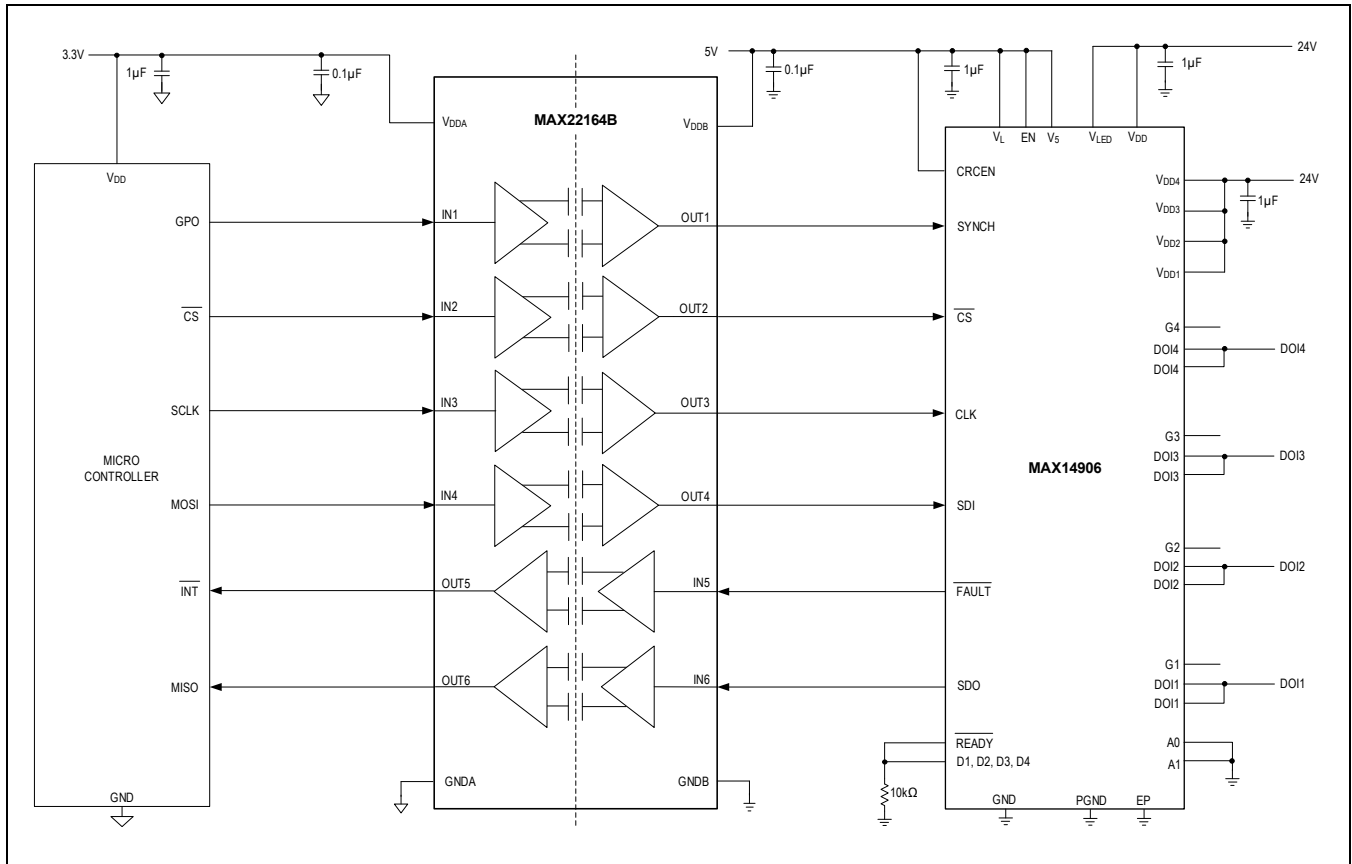

Product Selector Guide

MAX22163 6 C A E E /V +

CHANNEL CONFIGURATION
6: 6/0
5: 5/1
4: 4/2
3: 3/3

DEVICE CONFIGURATION	MAXIMUM DATA RATE	
	25Mbps	200Mbps
DEFAULT-HIGH OUTPUT	B	C
DEFAULT-LOW OUTPUT	E	F

LEAD-FREE/ROHS COMPLIANT

/V: AUTOMOTIVE GRADE PART
BLANK: GENERAL PURPOSE PART

PINS
E: 16

PACKAGE TYPE
E: QSOP

TEMP RANGE
-40°C TO +125°C

Ordering Information

PART NUMBER	CHANNEL CONFIGURATION	DATA RATE (Mbps)	DEFAULT OUTPUT	ISOLATION VOLTAGE (kV _{RMS})	TEMPERATURE RANGE (°C)	PIN-PACKAGE
GENERAL PURPOSE DEVICES						
MAX22163BAEE+*	3/3	25	High	3	-40 to +125	16-QSOP
MAX22163CAEE+	3/3	200	High	3	-40 to +125	16-QSOP
MAX22163EAEE+*	3/3	25	Low	3	-40 to +125	16-QSOP
MAX22163FAEE+	3/3	200	Low	3	-40 to +125	16-QSOP
MAX22164BAEE+*	4/2	25	High	3	-40 to +125	16-QSOP
MAX22164CAEE+	4/2	200	High	3	-40 to +125	16-QSOP
MAX22164EAEE+	4/2	25	Low	3	-40 to +125	16-QSOP
MAX22164FAEE+	4/2	200	Low	3	-40 to +125	16-QSOP
MAX22165BAEE+*	5/1	25	High	3	-40 to +125	16-QSOP
MAX22165CAEE+	5/1	200	High	3	-40 to +125	16-QSOP
MAX22165EAEE+*	5/1	25	Low	3	-40 to +125	16-QSOP
MAX22165FAEE+	5/1	200	Low	3	-40 to +125	16-QSOP
MAX22166BAEE+*	6/0	25	High	3	-40 to +125	16-QSOP
MAX22166CAEE+	6/0	200	High	3	-40 to +125	16-QSOP
MAX22166EAEE+*	6/0	25	Low	3	-40 to +125	16-QSOP
MAX22166FAEE+	6/0	200	Low	3	-40 to +125	16-QSOP
AUTOMOTIVE DEVICES						
MAX22163BAEE/V+*	3/3	25	High	3	-40 to +125	16-QSOP
MAX22163CAEE/V+*	3/3	200	High	3	-40 to +125	16-QSOP
MAX22163EAEE/V+*	3/3	25	Low	3	-40 to +125	16-QSOP
MAX22163FAEE/V+	3/3	200	Low	3	-40 to +125	16-QSOP

MAX22164BAEE/V+*	4/2	25	High	3	-40 to +125	16-QSOP
MAX22164CAEE/V+*	4/2	200	High	3	-40 to +125	16-QSOP
MAX22164EAEE/V+*	4/2	25	Low	3	-40 to +125	16-QSOP
MAX22164FAEE/V+*	4/2	200	Low	3	-40 to +125	16-QSOP
MAX22165BAEE/V+*	5/1	25	High	3	-40 to +125	16-QSOP
MAX22165CAEE/V+*	5/1	200	High	3	-40 to +125	16-QSOP
MAX22165EAEE/V+*	5/1	25	Low	3	-40 to +125	16-QSOP
MAX22165FAEE/V+*	5/1	200	Low	3	-40 to +125	16-QSOP
MAX22166BAEE/V+*	6/0	25	High	3	-40 to +125	16-QSOP
MAX22166CAEE/V+*	6/0	200	High	3	-40 to +125	16-QSOP
MAX22166EAEE/V+*	6/0	25	Low	3	-40 to +125	16-QSOP
MAX22166FAEE/V+*	6/0	200	Low	3	-40 to +125	16-QSOP

*Future product – contact Analog Devices for availability.

+Denotes a lead (Pb)–free/RoHS-compliant package.

/V Denotes an automotive qualified part.

Chip Information

PROCESS: BiCMOS

Revision History

REVISION NUMBER	REVISION DATE	DESCRIPTION	PAGES CHANGED
0	10/21	Initial Release	—
1	8/22	Removed future product designation from MAX22164EAE+ in the <i>Ordering Information</i> section	26
2	10/22	Removed future product designation from MAX22163FAEE+ in the <i>Ordering Information</i> section	26
3	11/22	Removed future product designation from MAX22164CAEE+ in the <i>Ordering Information</i> section	26
4	01/23	Removed future product designation from MAX22164FAEE+ and MAX22165FAEE+ in the <i>Ordering Information</i> section	26
5	06/23	Removed future product designation from MAX22163FAEE/V+ in the <i>Ordering Information</i> section	26
6	11/23	Removed future product designation from MAX22163CAEE+, MAX22165CAEE+, MAX22166FAEE+ in the <i>Ordering Information</i> section	26



Mouser Electronics

Authorized Distributor

Click to View Pricing, Inventory, Delivery & Lifecycle Information:

[Analog Devices Inc.:](#)

[MAX22166CAEE+](#) [MAX22166CAEE+T](#) [MAX22164FAEE+](#) [MAX22165FAEE+](#) [MAX22165FAEE+T](#)
[MAX22164FAEE+T](#) [MAX22164CAEE+](#) [MAX22164CAEE+T](#) [MAX22164EAE+](#) [MAX22164EAE+T](#)
[MAX22163FAEE+](#) [MAX22163FAEE+T](#) [MAX22163FAEE/V+](#) [MAX22163FAEE/V+T](#) [MAX22166FAEE+](#)
[MAX22163CAEE+](#) [MAX22163CAEE+T](#) [MAX22166FAEE+T](#) [MAX22165CAEE+](#) [MAX22165CAEE+T](#)