

16-Bit, 2 MSPS/1 MSPS/500 kSPS, Precision, Pseudo Differential, SAR ADCs

FEATURES

- ▶ Easy Drive expands signal chain flexibility
 - ▶ High-Z mode significantly reduces signal chain settling requirements
 - ▶ Fast conversion phase extends the ADC acquisition time
 - ▶ Input overvoltage protection clamp sinks up to 50 mA
- ▶ High performance
 - ▶ First conversion accurate, no latency or pipeline delay
 - ▶ Guaranteed 16-bit, no missing codes
 - ▶ Throughput: 2 MSPS/1 MSPS/500 kSPS options
 - ▶ INL: ± 1.0 LSB maximum
 - ▶ SNR: 93 dB at $f_{IN} = 1$ kHz, $V_{REF} = 5$ V
 - ▶ THD: -115 dB at $f_{IN} = 1$ kHz; -95 dB at $f_{IN} = 100$ kHz
 - ▶ Pseudo differential input range
 - ▶ Flexible external reference voltage range (2.4 V to 5.1 V)
- ▶ Low power
 - ▶ Single 1.8 V supply operation with 1.71 V to 5.5 V logic interface
 - ▶ 2.5 mW at 500 kSPS (VDD only)
 - ▶ 70 μ W at 10 kSPS, 14 mW typical at 2 MSPS (total power)
- ▶ SPI-/QSPI-/MICROWIRE-/DSP-compatible serial interface
- ▶ 10-lead packages: 3 mm \times 3 mm LFCSP, 3 mm \times 4.90 mm MSOP
- ▶ Guaranteed operation: -40°C to $+125^{\circ}\text{C}$

APPLICATIONS

- ▶ Automated test equipment
- ▶ Machine automation
- ▶ Medical equipment
- ▶ Battery-powered equipment
- ▶ Precision data acquisition systems
- ▶ Instrumentation and control systems

FUNCTIONAL BLOCK DIAGRAM

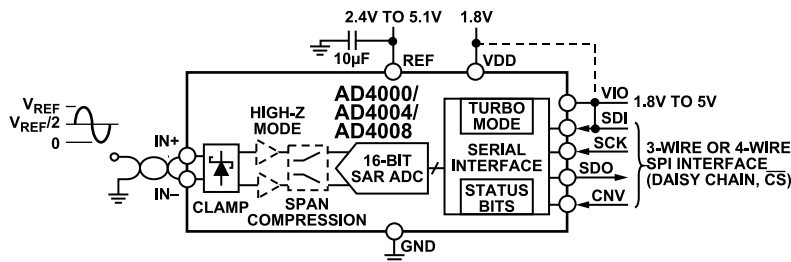

Figure 1.

GENERAL DESCRIPTION

The AD4000/AD4004/AD4008 are high accuracy, high speed, low power, 16-bit, precision successive approximation register (SAR) analog-to-digital converters (ADCs). These ADCs incorporate Easy Drive features, such as high-Z mode and an extended acquisition phase, which provide signal chain architectural flexibility by expanding the range of companion circuitry that can be paired with these ADCs.

Operating from a single power supply, VDD, these ADCs allow the reference voltage, V_{REF} , to be applied externally and set independently of the supply voltage. With fast device throughput up to 2 MSPS, the AD4000/AD4004/AD4008 can accurately capture high-frequency signals and implement oversampling techniques to alleviate the challenges associated with antialias filter designs. Additionally, the power consumption of these ADCs scales linearly with throughput.

The AD4000/AD4004/AD4008 eliminate the need for a negative supply to the ADC driver amplifier by employing input span compression, while preserving access to the full ADC code range. Furthermore, the input overvoltage clamp protects the ADC inputs against overvoltage events, minimizing disturbances on the reference pin and eliminating the need for external protection diodes.

By reducing the serial peripheral interface (SPI) clock rate requirements, the AD4000/AD4004/AD4008 reduce digital input and output power consumption, broaden digital host options, and simplify the task of sending data across digital isolation. The SPI-compatible serial user interface supports 1.8 V, 2.5 V, 3.3 V, and 5 V logic by using the separate VIO logic supply.

TABLE OF CONTENTS

Features.....	1	Ease of Drive Features.....	22
Applications.....	1	Voltage Reference Input.....	23
General Description.....	1	Power Supply.....	23
Functional Block Diagram.....	1	Digital Interface.....	23
Specifications.....	3	Register Read/Write Functionality.....	26
Timing Specifications.....	6	Status Bits.....	28
Absolute Maximum Ratings.....	8	$\overline{\text{CS}}$ Mode, 3-Wire Turbo Mode.....	29
Thermal Resistance.....	8	$\overline{\text{CS}}$ Mode, 3-Wire Without Busy Indicator.....	30
ESD Caution.....	8	$\overline{\text{CS}}$ Mode, 3-Wire With Busy Indicator.....	31
Pin Configurations and Function Descriptions.....	9	$\overline{\text{CS}}$ Mode, 4-Wire Turbo Mode.....	32
Typical Performance Characteristics.....	10	$\overline{\text{CS}}$ Mode, 4-Wire Without Busy Indicator.....	33
Terminology.....	16	$\overline{\text{CS}}$ Mode, 4-Wire With Busy Indicator.....	34
Theory of Operation.....	17	Daisy-Chain Mode.....	35
Circuit Information.....	17	Layout Guidelines.....	36
Converter Operation.....	18	Evaluating the AD4000/AD4004/AD4008	
Transfer Functions.....	18	Performance.....	36
Applications Information.....	19	Outline Dimensions.....	37
Typical Application Diagrams.....	19	Ordering Guide.....	38
Analog Inputs.....	20	Evaluation Boards.....	38
Driver Amplifier Choice.....	21		

REVISION HISTORY**5/2023—Rev. E to Rev. F**

Changes to Features Section.....	1
Changes to General Description Section.....	1
Deleted Figure 2; Renumbered Sequentially.....	1
Change to Figure 2.....	9
Changes to Table 10.....	21

SPECIFICATIONS

VDD = 1.71 V to 1.89 V, VIO = 1.71 V to 5.5 V, REF = V_{REF} = 5 V, all specifications T_{MIN} to T_{MAX}, high-Z mode disabled, span compression disabled, turbo mode enabled, and sampling frequency (f_S) = 2 MSPS for the AD4000, f_S = 1 MSPS for the AD4004, and f_S = 500 kSPS for the AD4008, unless otherwise noted.

Table 1.

Parameter	Test Conditions/Comments	Min	Typ	Max	Unit
RESOLUTION		16			Bits
ANALOG INPUT					
Voltage Range	IN+ voltage (V _{IN+}) - IN- voltage (V _{IN-})	0		V _{REF}	V
Operating Input Voltage	V _{IN+} to GND	-0.1		V _{REF} + 0.1	V
	V _{IN-} to GND	-0.1		+0.1	V
	Span compression enabled	0.1 × V _{REF}		0.9 × V _{REF}	V
Analog Input Current	Acquisition phase, T = 25°C		0.3		nA
	High-Z mode enabled, converting dc input at 2 MSPS		1		μA
THROUGHPUT					
Complete Cycle					
AD4000		500			ns
AD4004		1000			ns
AD4008		2000			ns
Conversion Time		270	290	320	ns
Acquisition Phase ¹					
AD4000		290			ns
AD4004		790			ns
AD4008		1790			ns
Throughput Rate ²					
AD4000		0		2	MSPS
AD4004		0		1	MSPS
AD4008		0		500	kSPS
Transient Response ³			150		ns
DC ACCURACY					
No Missing Codes		16			Bits
Integral Nonlinearity Error (INL)	T = 0°C to 85°C	-1.0	±0.2	+1.0	LSB
Differential Nonlinearity Error (DNL)		-0.8	±0.2	+0.8	LSB
Transition Noise		-0.5	±0.15	+0.5	LSB
Zero Error		-4.5		+4.5	LSB
Zero Error Drift ⁴		-0.55		+0.55	ppm/°C
Gain Error		-20	±3	+20	LSB
Gain Error Drift ⁴		-0.92		+0.92	ppm/°C
Power Supply Sensitivity	VDD = 1.8 V ± 5%		0.5		LSB
1/f Noise ⁵	Bandwidth = 0.1 Hz to 10 Hz		6		μV p-p
AC ACCURACY					
Dynamic Range			93.5		dB
Oversampled Dynamic Range	Oversampling ratio (OSR) = 2		96		dB
	OSR = 256		117		dB
	OSR = 1024		123		dB
Total RMS Noise			37		μV rms
f _{IN} = 1 kHz, -0.5 dBFS, V _{REF} = 5 V					
Signal-to-Noise Ratio (SNR)		91	93		dB
Spurious-Free Dynamic Range (SFDR)			112		dB

SPECIFICATIONS

Table 1. (Continued)

Parameter	Test Conditions/Comments	Min	Typ	Max	Unit
Total Harmonic Distortion (THD)			-115		dB
Signal-to-Noise-and-Distortion Ratio (SINAD)		91	92.5		dB
$f_{IN} = 1 \text{ kHz}$, -0.5 dBFS , $V_{REF} = 2.5 \text{ V}$					
SNR		85.5	87.5		dB
SFDR			115		dB
THD			-113		dB
SINAD		85.5	87		dB
$f_{IN} = 100 \text{ kHz}$, -0.5 dBFS , $V_{REF} = 5 \text{ V}$					
SNR			90		dB
THD			-95		dB
SINAD			89		dB
$f_{IN} = 400 \text{ kHz}$, -0.5 dBFS , $V_{REF} = 5 \text{ V}$					
SNR			85		dB
THD			-91		dB
SINAD			84		dB
-3 dB Input Bandwidth			10		MHz
Aperture Delay			1		ns
Aperture Jitter			1		ps rms
REFERENCE					
V_{REF} Voltage Range	REF - GND	2.4		5.1	V
Current	$V_{REF} = 5 \text{ V}$				
AD4000	2 MSPS		0.75		mA
AD4004	1 MSPS		0.325		mA
AD4008	500 KSPS		0.185		mA
INPUT OVERVOLTAGE CLAMP					
I_{IN+}/I_{IN-} Current (I_{IN+}/I_{IN-})	$V_{REF} = 5 \text{ V}$			50	mA
	$V_{REF} = 2.5 \text{ V}$			50	mA
V_{IN+}/V_{IN-} at Maximum I_{IN+}/I_{IN-}	$V_{REF} = 5 \text{ V}$		5.4		V
	$V_{REF} = 2.5 \text{ V}$		3.1		V
V_{IN+}/V_{IN-} Clamp On/Off Threshold	$V_{REF} = 5 \text{ V}$	5.25	5.4		V
	$V_{REF} = 2.5 \text{ V}$	2.68	2.8		V
Deactivation Time			360		ns
REF Current at Maximum I_{IN+}	$V_{IN+} > V_{REF}$		100		μA
DIGITAL INPUTS					
Logic Levels					
Input Voltage Low (V_{IL})	$V_{IO} > 2.7 \text{ V}$	-0.3		$+0.3 \times V_{IO}$	V
	$V_{IO} \leq 2.7 \text{ V}$	-0.3		$+0.2 \times V_{IO}$	V
Input Voltage High (V_{IH})	$V_{IO} > 2.7 \text{ V}$	$0.7 \times V_{IO}$		$V_{IO} + 0.3$	V
	$V_{IO} \leq 2.7 \text{ V}$	$0.8 \times V_{IO}$		$V_{IO} + 0.3$	V
Input Current Low (I_{IL})		-1		+1	μA
Input Current High (I_{IH})		-1		+1	μA
Input Pin Capacitance			6		pF
DIGITAL OUTPUTS					
Data Format		Serial 16 bits, straight binary			
Pipeline Delay		Conversion results available immediately after completed conversion			
Output Voltage, Low (V_{OL})	Output current = $500 \mu\text{A}$			0.4	V
Output Voltage, High (V_{OH})	Output current = $-500 \mu\text{A}$	$V_{IO} - 0.3$			V

SPECIFICATIONS

Table 1. (Continued)

Parameter	Test Conditions/Comments	Min	Typ	Max	Unit
POWER SUPPLIES					
VDD		1.71	1.8	1.89	V
VIO		1.71		5.5	V
Standby Current	VDD and VIO = 1.8 V, T = 25°C		1.6		μA
Power Dissipation	VDD = 1.8 V, VIO = 1.8 V, V _{REF} = 5 V				
	10 kSPS, high-Z mode disabled		70		μW
	500 kSPS, high-Z mode disabled		3.5	4.2	mW
	1 MSPS, high-Z mode disabled		7	8.2	mW
	2 MSPS, high-Z mode disabled		14	16	mW
	500 kSPS, high-Z mode enabled		4	5	mW
	1 MSPS, high-Z mode enabled		8	9.9	mW
	2 MSPS, high-Z mode enabled		16	19	mW
VDD Only	500 kSPS, high-Z mode disabled		2.5		mW
	1 MSPS, high-Z mode disabled		4.9		mW
	2 MSPS, high-Z mode disabled		9.75		mW
REF Only	500 kSPS, high-Z mode disabled		0.9		mW
	1 MSPS, high-Z mode disabled		1.9		mW
	2 MSPS, high-Z mode disabled		3.75		mW
VIO Only	500 kSPS, high-Z mode disabled		0.1		mW
	1 MSPS, high-Z mode disabled		0.2		mW
	2 MSPS, high-Z mode disabled		0.5		mW
Energy per Conversion			7		nJ/sample
TEMPERATURE RANGE					
Specified Performance	T _{MIN} to T _{MAX}	-40		+125	°C

¹ The acquisition phase is the time available for the input sampling capacitors to acquire a new input with the ADC running at a throughput rate of 2 MSPS for the AD4000, 1 MSPS for the AD4004, and 500 kSPS for the AD4008.

² A throughput rate of 2 MSPS can only be achieved with turbo mode enabled and a minimum SCK rate of 70 MHz. Refer to Table 4 for the maximum achievable throughput for different modes of operation.

³ Transient response is the time required for the ADC to acquire a full-scale input step to ±0.5 LSB accuracy.

⁴ The minimum and maximum values are guaranteed by characterization, but not production tested.

⁵ See the 1/f noise plot in Figure 24.

SPECIFICATIONS

TIMING SPECIFICATIONS

VDD = 1.71 V to 1.89 V, VIO = 1.71 V to 5.5 V, VREF = 5 V, all specifications T_{MIN} to T_{MAX}, high-Z mode disabled, span compression disabled, turbo mode enabled, and f_S = 2 MSPS for the AD4000, f_S = 1 MSPS for the AD4004, and f_S = 500 kSPS for the AD4008, unless otherwise noted. See Figure 45 to Figure 48, Figure 50, Figure 52, Figure 54, Figure 56, Figure 58, Figure 60, and Figure 62 for timing diagrams.

Table 2. Digital Interface Timing

Parameter ¹	Symbol	Min	Typ	Max	Unit
CONVERSION TIME—CNV RISING EDGE TO DATA AVAILABLE	t _{CONV}	270	290	320	ns
ACQUISITION PHASE ²	t _{ACQ}				
AD4000		290			ns
AD4004		790			ns
AD4008		1790			ns
TIME BETWEEN CONVERSIONS	t _{CYC}				
AD4000		500			ns
AD4004		1000			ns
AD4008		2000			ns
CNV PULSE WIDTH ($\overline{\text{CS}}$ MODE) ³	t _{CNVH}	10			ns
SCK PERIOD ($\overline{\text{CS}}$ MODE) ⁴	t _{SCK}				
VIO > 2.7 V		9.8			ns
VIO > 1.7 V		12.3			ns
SCK PERIOD (DAISY-CHAIN MODE) ⁵	t _{SCK}				
VIO > 2.7 V		20			ns
VIO > 1.7 V		25			ns
SCK LOW TIME	t _{SCKL}	3			ns
SCK HIGH TIME	t _{SCKH}	3			ns
SCK FALLING EDGE TO DATA REMAINS VALID DELAY	t _{HSDO}	1.5			ns
SCK FALLING EDGE TO DATA VALID DELAY	t _{DSDO}				
VIO > 2.7 V				7.5	ns
VIO > 1.7 V				10.5	ns
CNV OR SDI LOW TO SDO D15 MOST SIGNIFICANT BIT (MSB) VALID DELAY ($\overline{\text{CS}}$ MODE)	t _{EN}				
VIO > 2.7 V				10	ns
VIO > 1.7 V				13	ns
CNV RISING EDGE TO FIRST SCK RISING EDGE DELAY	t _{QUIET1}	190			ns
LAST SCK FALLING EDGE TO CNV RISING EDGE DELAY ⁶	t _{QUIET2}	60			ns
CNV OR SDI HIGH OR LAST SCK FALLING EDGE TO SDO HIGH IMPEDANCE ($\overline{\text{CS}}$ MODE)	t _{DIS}			20	ns
SDI VALID SETUP TIME FROM CNV RISING EDGE	t _{SSDICNV}	2			ns
SDI VALID HOLD TIME FROM CNV RISING EDGE ($\overline{\text{CS}}$ MODE)	t _{HSDICNV}	2			ns
SCK VALID HOLD TIME FROM CNV RISING EDGE (DAISY-CHAIN MODE)	t _{HSCKCNV}	12			ns
SDI VALID SETUP TIME FROM SCK RISING EDGE (DAISY-CHAIN MODE)	t _{SSDISCK}	2			ns
SDI VALID HOLD TIME FROM SCK RISING EDGE (DAISY-CHAIN MODE)	t _{HSDISCK}	2			ns

¹ Timing parameters measured with respect to a falling edge are defined as triggered at x% VIO. Timing parameters measured with respect to a rising edge are defined as triggered at y% VIO. For VIO ≤ 2.7 V, x = 80 and y = 20. For VIO > 2.7 V, x = 70 and y = 30. The minimum VIH and maximum VIL are used. See the digital inputs specifications in Table 1.

² The acquisition phase is the time available for the input sampling capacitors to acquire a new input with the ADC running at a throughput rate of 2 MSPS for the AD4000, 1 MSPS for the AD4004, and 500 kSPS for the AD4008.

³ For turbo mode, t_{CNVH} must match the t_{QUIET1} minimum.

SPECIFICATIONS

- ⁴ A throughput rate of 2 MSPS can only be achieved with turbo mode enabled and a minimum SCK frequency of 70 MHz. Refer to [Table 4](#) for the maximum achievable throughput for different modes of operation. See the [Serial Clock Frequency Requirements](#) section for guidelines on determining the minimum SCK rate required for a given throughput.
- ⁵ A 50% duty cycle is assumed for SCK.
- ⁶ See [Figure 23](#) for SINAD, SNR, and ENOB vs. $t_{\text{QUIET}2}$.

Table 3. Register Read/Write Timing

Parameter	Symbol ¹	Min	Typ	Max	Unit
READ/WRITE OPERATION					
CNV Pulse Width ²	t_{CNVH}	10			ns
SCK Period	t_{SCK}				
VIO > 2.7 V		9.8			ns
VIO > 1.7 V		12.3			ns
SCK Low Time	t_{SCKL}	3			ns
SCK High Time	t_{SCKH}	3			ns
READ OPERATION					
CNV Low to SDO D15 MSB Valid Delay	t_{EN}				
VIO > 2.7 V				10	ns
VIO > 1.7 V				13	ns
SCK Falling Edge to Data Remains Valid	t_{HSDO}	1.5			ns
SCK Falling Edge to Data Valid Delay	t_{DSDO}				
VIO > 2.7 V				7.5	ns
VIO > 1.7 V				10.5	ns
CNV Rising Edge to SDO High Impedance	t_{DIS}			20	ns
WRITE OPERATION					
SDI Valid Setup Time from SCK Rising Edge	t_{SSDISCK}	2			ns
SDI Valid Hold Time from SCK Rising Edge	t_{HSDISCK}	2			ns
CNV Rising Edge to SCK Edge Hold Time	t_{HCNVSCK}	0			ns
CNV Falling Edge to SCK Active Edge Setup Time	t_{SCNVSCK}	6			ns

¹ See [Figure 45](#) to [Figure 48](#), [Figure 50](#), [Figure 52](#), [Figure 54](#), [Figure 56](#), [Figure 58](#), [Figure 60](#), and [Figure 62](#).

² For turbo mode, t_{CNVH} must match the $t_{\text{QUIET}1}$ minimum.

Table 4. Achievable Throughput for Different Modes of Operation

Parameter	Test Conditions/Comments	Min	Typ	Max	Unit
THROUGHPUT, $\overline{\text{CS}}$ MODE					
3-Wire and 4-Wire Turbo Mode	$f_{\text{SCK}} = 100 \text{ MHz}$, VIO $\geq 2.7 \text{ V}$			2	MSPS
	$f_{\text{SCK}} = 80 \text{ MHz}$, VIO < 2.7 V			2	MSPS
3-Wire and 4-Wire Turbo Mode and Six Status Bits	$f_{\text{SCK}} = 100 \text{ MHz}$, VIO $\geq 2.7 \text{ V}$			2	MSPS
	$f_{\text{SCK}} = 80 \text{ MHz}$, VIO < 2.7 V			1.86	MSPS
3-Wire and 4-Wire Mode	$f_{\text{SCK}} = 100 \text{ MHz}$, VIO $\geq 2.7 \text{ V}$			1.82	MSPS
	$f_{\text{SCK}} = 80 \text{ MHz}$, VIO < 2.7 V			1.69	MSPS
3-Wire and 4-Wire Mode and Six Status Bits	$f_{\text{SCK}} = 100 \text{ MHz}$, VIO $\geq 2.7 \text{ V}$			1.64	MSPS
	$f_{\text{SCK}} = 80 \text{ MHz}$, VIO < 2.7 V			1.5	MSPS

ABSOLUTE MAXIMUM RATINGS

Note that the input overvoltage clamp cannot sustain the overvoltage condition for an indefinite amount of time.

Table 5.

Parameter	Rating
Analog Inputs	
IN+, IN- to GND ¹	-0.3 V to $V_{REF} + 0.4$ V or ± 130 mA ²
Supply Voltage	
REF, VIO to GND	-0.3 V to +6.0 V
VDD to GND	-0.3 V to +2.1 V
VDD to VIO	-6 V to +2.4 V
Digital Inputs to GND	-0.3 V to VIO + 0.3 V
Digital Outputs to GND	-0.3 V to VIO + 0.3 V
Storage Temperature Range	-65°C to +150°C
Junction Temperature	150°C
Lead Temperature Soldering	260°C reflow as per JEDEC J-STD-020
ESD Ratings	
Human Body Model	4 kV
Machine Model	200 V
Field Induced Charged Device Model	1.25 kV

¹ See the [Analog Inputs](#) section for an explanation of IN+ and IN-.

² Current condition tested over a 10 ms time interval.

Stresses at or above those listed under Absolute Maximum Ratings may cause permanent damage to the product. This is a stress rating only; functional operation of the product at these or any other conditions above those indicated in the operational section of this specification is not implied. Operation beyond the maximum operating conditions for extended periods may affect product reliability.

THERMAL RESISTANCE

Thermal performance is directly linked to printed circuit board (PCB) design and operating environment. Careful attention to PCB thermal design is required.

θ_{JA} is the natural convection junction-to-ambient thermal resistance measured in a one cubic foot sealed enclosure.

θ_{JC} is the junction-to-case thermal resistance.

Table 6. Thermal Resistance

Package Type ¹	θ_{JA}	θ_{JC}	Unit
RM-10	147	38	°C/W
CP-10-9	114	33	°C/W

¹ Test Condition 1: thermal impedance simulated values are based upon use of 2S2P JEDEC PCB. See the [Ordering Guide](#).

ESD CAUTION



ESD (electrostatic discharge) sensitive device. Charged devices and circuit boards can discharge without detection. Although this product features patented or proprietary protection circuitry, damage may occur on devices subjected to high energy ESD. Therefore, proper ESD precautions should be taken to avoid performance degradation or loss of functionality.

PIN CONFIGURATIONS AND FUNCTION DESCRIPTIONS

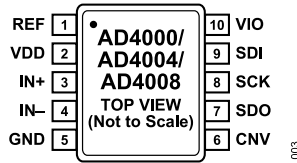
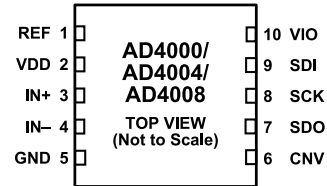

Figure 2. 10-Lead MSOP Pin Configuration



NOTES
1. CONNECT THE EXPOSED PAD TO GND. THIS CONNECTION IS NOT REQUIRED TO MEET THE SPECIFIED PERFORMANCE.

Figure 3. 10-Lead LFCSP Pin Configuration

Table 7. Pin Function Descriptions

Pin No.	Mnemonic	Type ¹	Description
1	REF	AI	Reference Input Voltage. The V_{REF} range is 2.4 V to 5.1 V. This pin is referred to the GND pin and must be decoupled closely to the GND pin with a 10 μ F, X7R ceramic capacitor.
2	VDD	P	1.8 V Power Supply. The VDD range is 1.71 V to 1.89 V. Bypass VDD to GND with a 0.1 μ F ceramic capacitor.
3	IN+	AI	Analog Input. This input is referred to analog ground sense pin (IN-). The device samples the voltage differential between IN+ and IN- on the leading edge on CNV. The operating input range of IN+ - IN- is 0 V to V_{REF} .
4	IN-	AI	Analog Input Ground Sense. Connect this pin to the analog ground plane or to a remote sense ground.
5	GND	P	Power Supply Ground. Connect to the ground plane of the board.
6	CNV	DI	Convert Input. This input has multiple functions. On the leading edge, the input initiates the conversions and selects the interface mode of the device, which is either daisy-chain mode or \overline{CS} mode. In \overline{CS} mode, the SDO pin is enabled when CNV is low. In daisy-chain mode, the data is read when CNV is high.
7	SDO	DO	Serial Data Output. The conversion result is output on this pin. The SDO pin is synchronized to the SCK signal on the SCK pin.
8	SCK	DI	Serial Data Clock Input. When the device is selected, the conversion result is shifted out by this clock.
9	SDI	DI	Serial Data Input. This input provides multiple features and selects the interface mode of the ADC as follows: Daisy-chain mode is selected if SDI is low during the CNV rising edge. In this mode, SDI is used as a data input to daisy-chain the conversion results of two or more ADCs onto a single SDO line. The digital data level on SDI is output on SDO with a delay of 16 SCK cycles. \overline{CS} mode is selected if SDI is high during the CNV rising edge. In this mode, either SDI or CNV can enable the serial output signals when low. If SDI or CNV is low when the conversion is complete, the busy indicator feature is enabled. With CNV low, program the device by clocking in a 16-bit word on SDI on the rising edge of SCK.
10	VIO	P	Input/Output Interface Digital Power. Nominally, this pin is at the same supply as the host interface (1.8 V, 2.5 V, 3 V, or 5 V). Bypass VIO to GND with a 0.1 μ F ceramic capacitor.
N/A ²	EPAD	P	Exposed Pad. Connect the exposed pad to GND. This connection is not required to meet the specified performance. Note that the exposed pad only applies to the LFCSP.

¹ AI is analog input, P is power, DI is digital input, and DO is digital output.

² N/A means not applicable.

TYPICAL PERFORMANCE CHARACTERISTICS

VDD = 1.71 V to 1.89 V, VIO = 1.71 V to 5.5 V, VREF = 5 V, all specifications TMIN to TMAX, high-Z mode disabled, span compression disabled, turbo mode enabled, and fS = 2 MSPS for the AD4000, fS = 1 MSPS for the AD4004, and fS = 500 kSPS for the AD4008, unless otherwise noted.

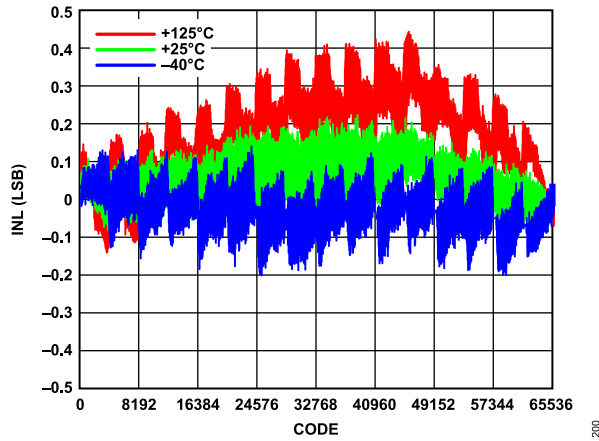

Figure 4. INL vs. Code for Various Temperatures, VREF = 5 V

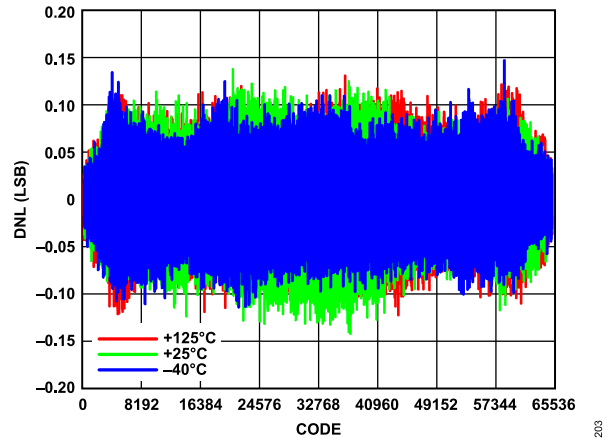

Figure 7. DNL vs. Code for Various Temperatures, VREF = 5 V

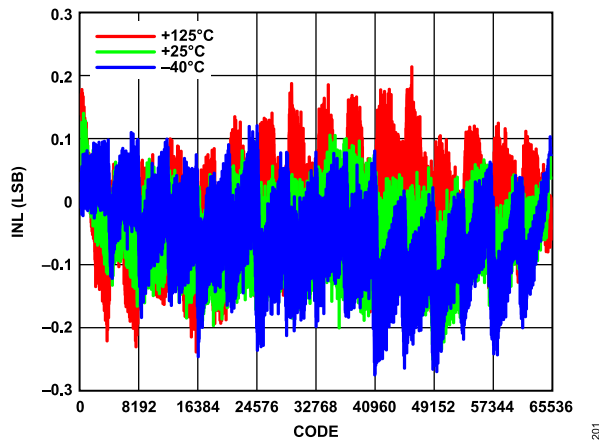

Figure 5. INL vs. Code for Various Temperatures, VREF = 2.5 V

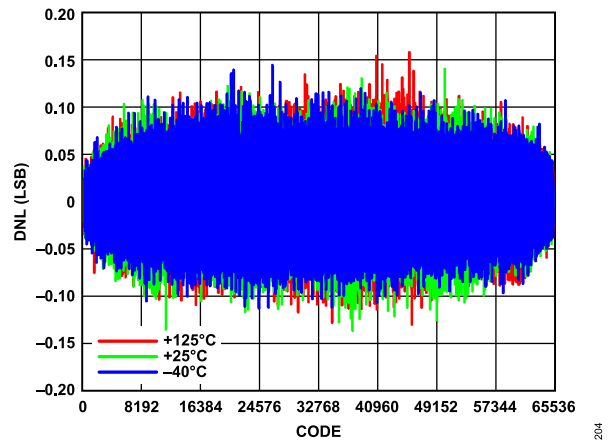

Figure 8. DNL vs. Code for Various Temperatures, VREF = 2.5 V

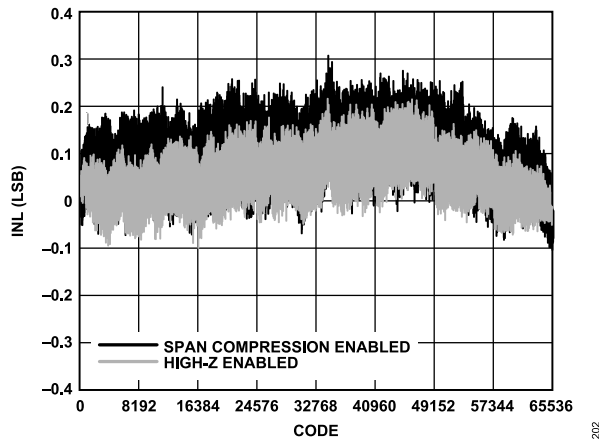

Figure 6. INL vs. Code for High-Z and Span Compression Modes Enabled, VREF = 5 V

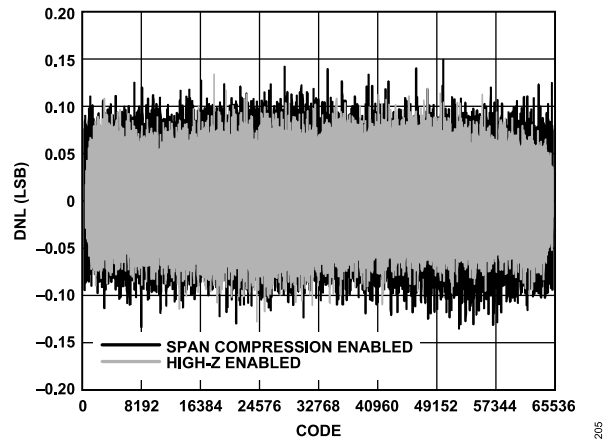

Figure 9. DNL vs. Code for High-Z and Span Compression Modes Enabled, VREF = 5 V

TYPICAL PERFORMANCE CHARACTERISTICS

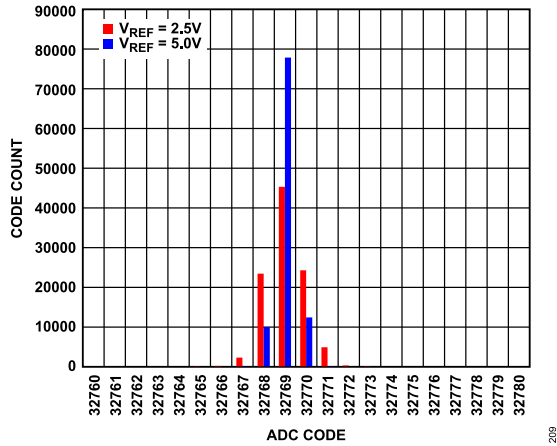

Figure 10. Histogram of a DC Input at Code Center, $V_{REF} = 2.5\text{ V}$ and $V_{REF} = 5\text{ V}$

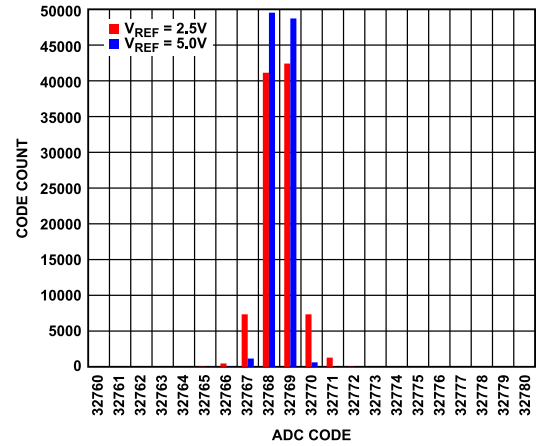

Figure 13. Histogram of a DC Input at Code Transition, $V_{REF} = 2.5\text{ V}$ and $V_{REF} = 5\text{ V}$

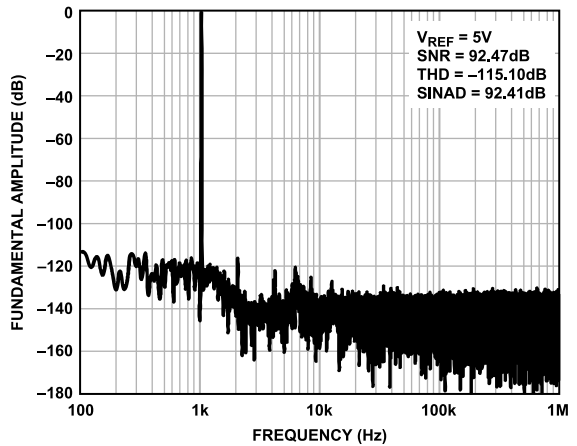

Figure 11. 1 kHz, -0.5 dBFS Input Tone Fast Fourier Transform (FFT), $V_{REF} = 5\text{ V}$

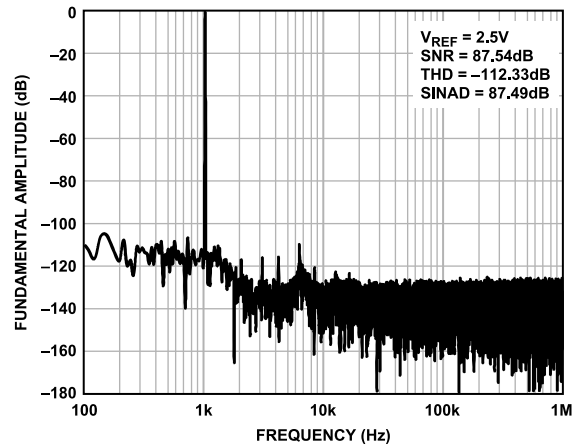

Figure 14. 1 kHz, -0.5 dBFS Input Tone FFT, $V_{REF} = 2.5\text{ V}$

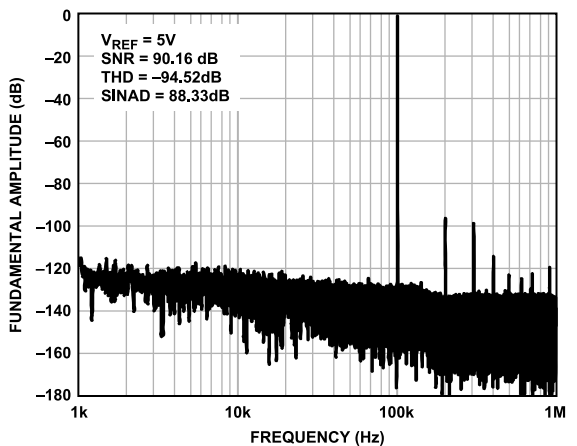

Figure 12. 100 kHz, -0.5 dBFS Input Tone FFT

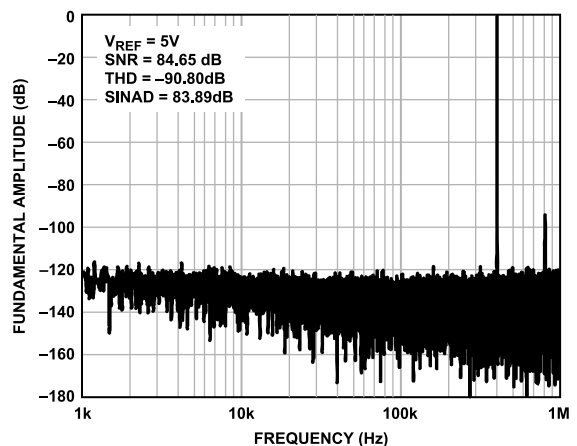

Figure 15. 400 kHz, -0.5 dBFS Input Tone FFT

TYPICAL PERFORMANCE CHARACTERISTICS

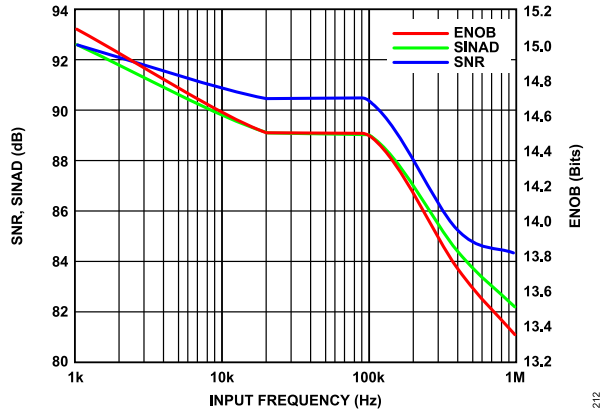

Figure 16. SNR, SINAD, and Effective Number of Bits (ENOB) vs. Input Frequency

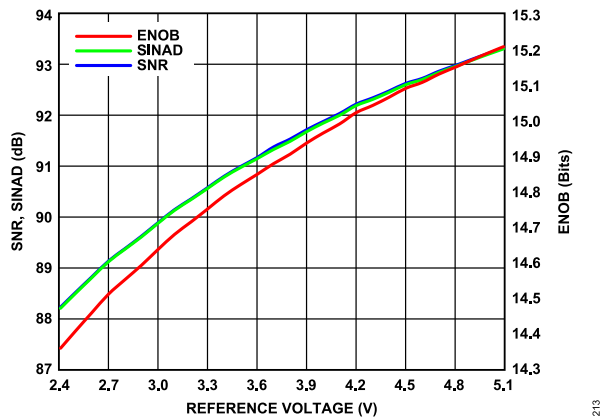

Figure 17. SNR, SINAD, and ENOB vs. Reference Voltage, $f_{IN} = 1$ kHz

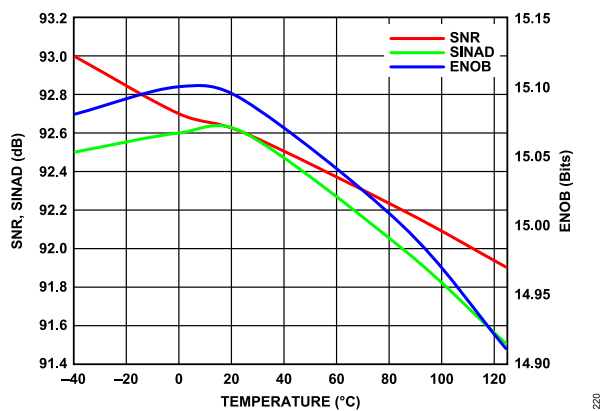

Figure 18. SNR, SINAD, and ENOB vs. Temperature, $f_{IN} = 1$ kHz

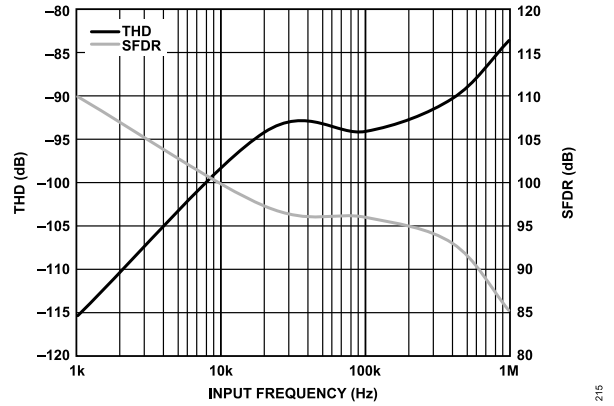

Figure 19. THD and SFDR vs. Input Frequency

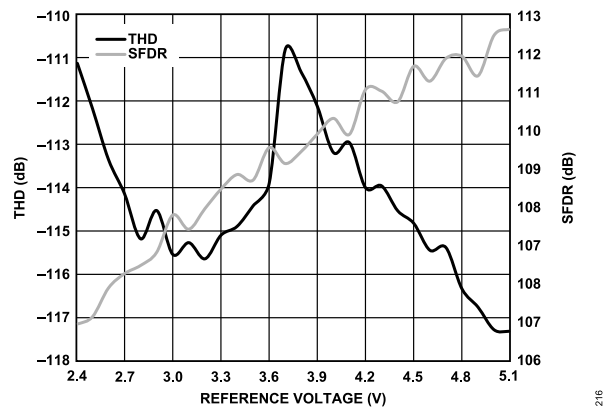

Figure 20. THD and SFDR vs. Reference Voltage, $f_{IN} = 1$ kHz

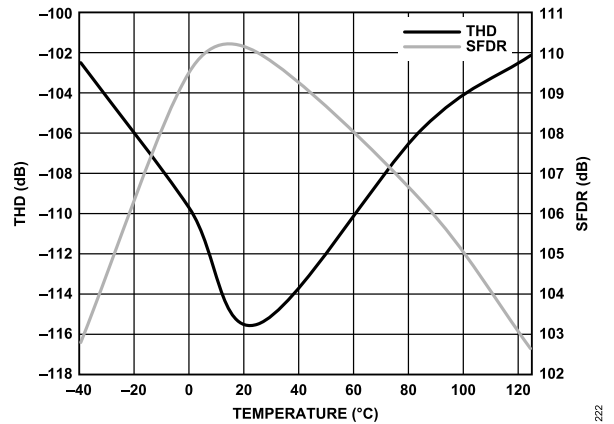

Figure 21. THD and SFDR vs. Temperature, $f_{IN} = 1$ kHz

TYPICAL PERFORMANCE CHARACTERISTICS

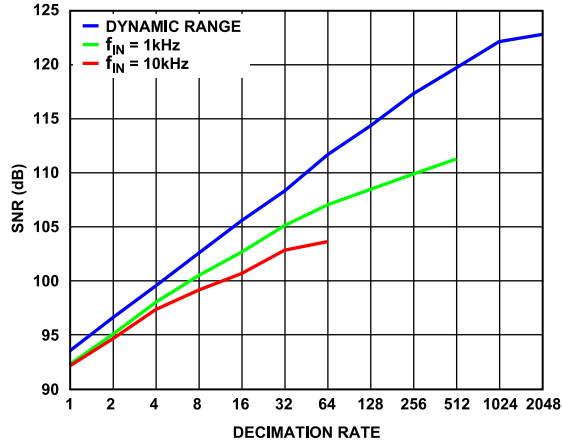

Figure 22. SNR vs. Decimation Rate for Various Input Frequencies, 2 MSPS

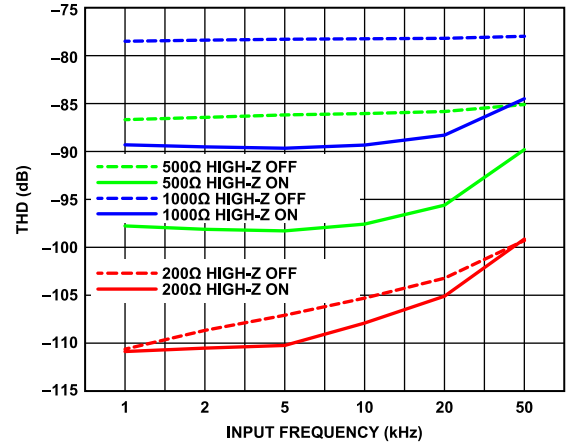

Figure 25. THD vs. Input Frequency for Various Source Impedances

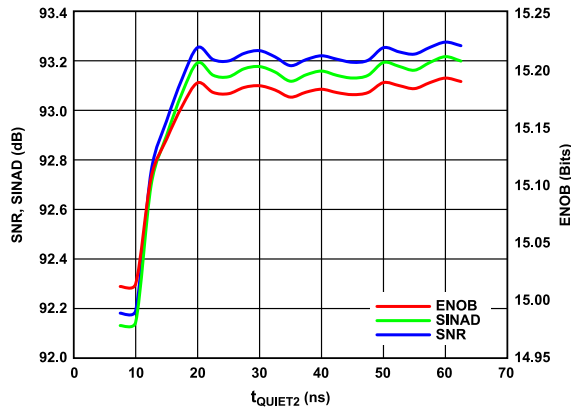

Figure 23. SNR, SINAD, and ENOB vs. t_{QUIET2}

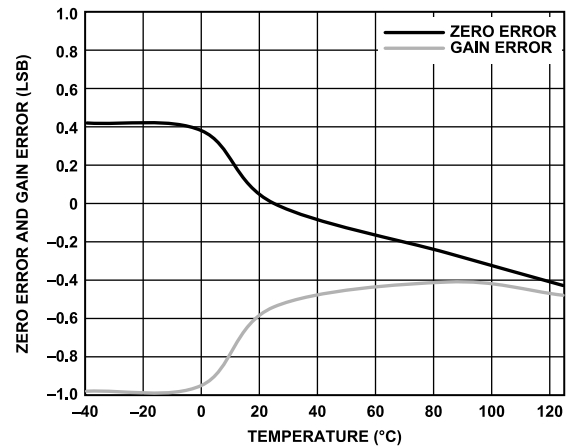

Figure 26. Zero Error and Gain Error vs. Temperature

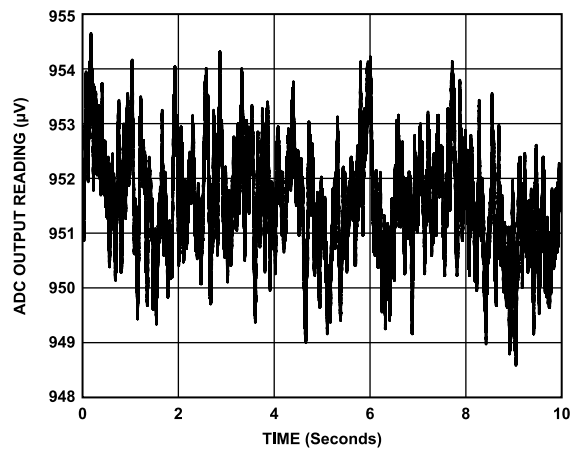

Figure 24. 1/f Noise for 0.1 Hz to 10 Hz Bandwidth, 50 kSPS, 2500 Samples Averaged per Reading

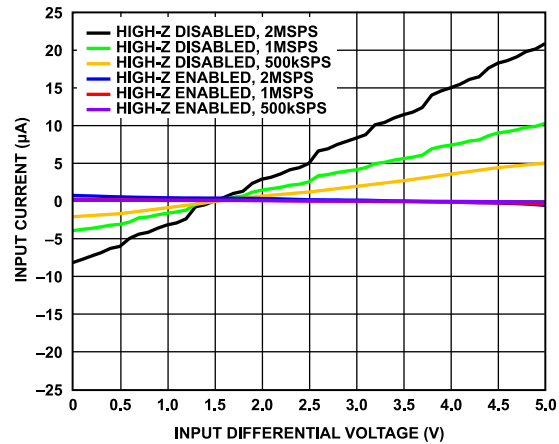

Figure 27. Analog Input Current vs. Input Differential Voltage

TYPICAL PERFORMANCE CHARACTERISTICS

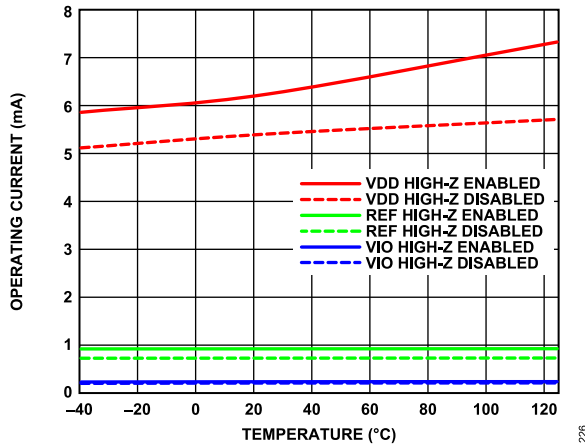

Figure 28. Operating Current vs. Temperature, AD4000, 2 MSPS

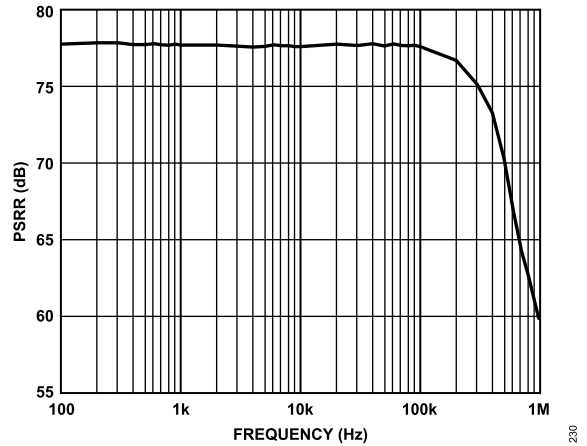

Figure 31. PSRR vs. Frequency

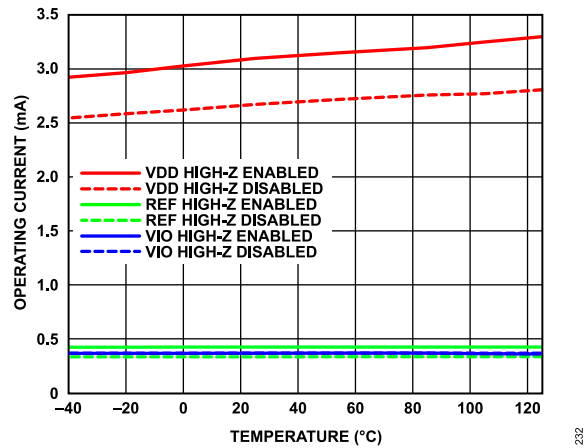

Figure 29. Operating Current vs. Temperature, AD4004, 1 MSPS

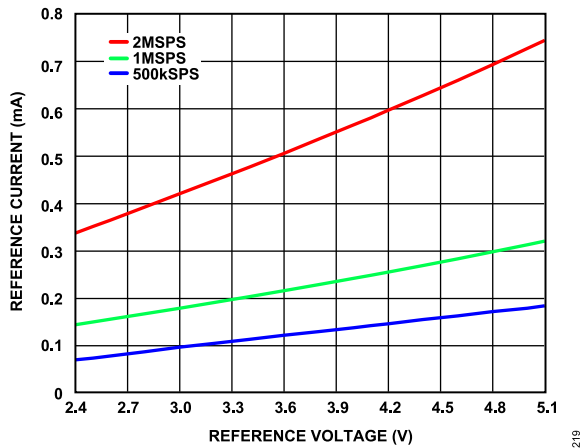

Figure 32. Reference Current vs. Reference Voltage

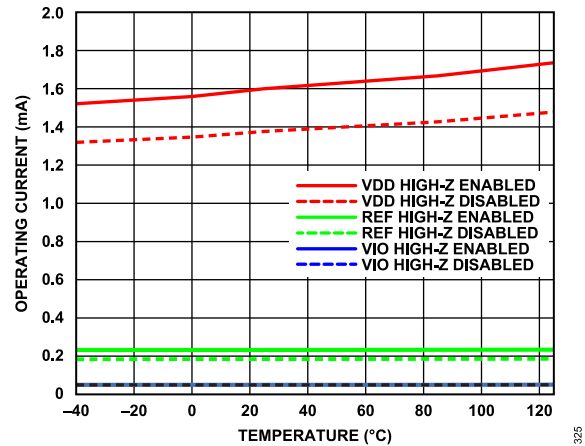

Figure 30. Operating Current vs. Temperature, AD4008, 500 kSPS

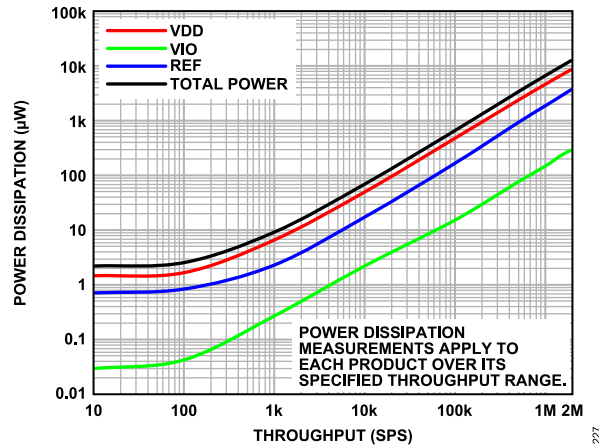

Figure 33. Power Dissipation vs. Throughput

TYPICAL PERFORMANCE CHARACTERISTICS

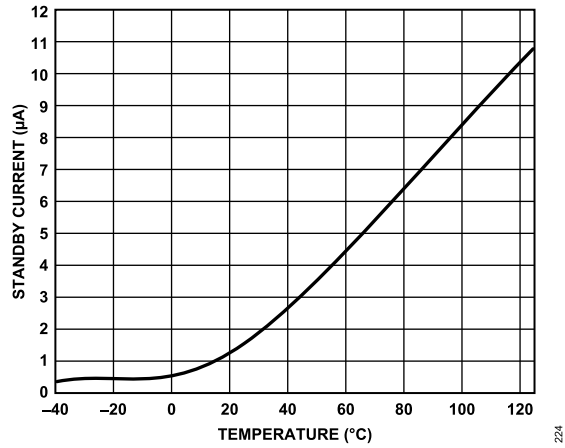

Figure 34. Standby Current vs. Temperature

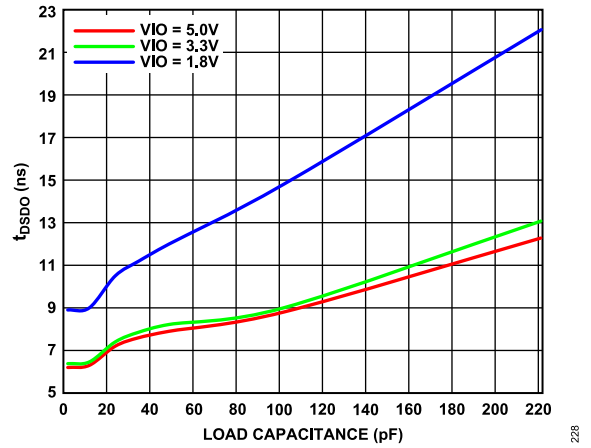

Figure 35. t_{DS(0)} vs. Load Capacitance

TERMINOLOGY

Integral Nonlinearity Error (INL)

INL is the deviation of each individual code from a line drawn from negative full scale through positive full scale. The point used as negative full scale occurs $\frac{1}{2}$ LSB before the first code transition. Positive full scale is defined as a level $1\frac{1}{2}$ LSB beyond the last code transition. The deviation is measured from the middle of each code to the true straight line (see [Figure 37](#)).

Differential Nonlinearity Error (DNL)

In an ideal ADC, code transitions are 1 LSB apart. DNL is the maximum deviation from this ideal value. It is often specified in terms of resolution for which no missing codes are guaranteed.

Zero Error

Zero error is the difference between the ideal voltage that results in the first code transition ($\frac{1}{2}$ LSB above analog ground) and the actual voltage producing that code.

Gain Error

The first transition (from 100 ... 00 to 100 ... 01) occurs at a level $\frac{1}{2}$ LSB above nominal negative full scale (-4.999981 V for the ± 5 V range). The last transition (from 011 ... 10 to 011 ... 11) occurs for an analog voltage $1\frac{1}{2}$ LSB below the nominal full scale ($+4.999943$ V for the ± 5 V range). The gain error is the deviation of the difference between the actual level of the last transition and the actual level of the first transition from the difference between the ideal levels.

Spurious-Free Dynamic Range (SFDR)

SFDR is the difference, in decibels (dB), between the rms amplitude of the input signal and the peak spurious signal.

Effective Number of Bits (ENOB)

ENOB is a measurement of the resolution with a sine wave input. It is related to SINAD as follows:

$$ENOB = (SINAD - 1.76)/6.02 \quad (1)$$

ENOB is expressed in bits and SINAD is expressed in dB.

Total Harmonic Distortion (THD)

THD is the ratio of the rms sum of the first five harmonic components to the rms value of a full-scale input signal and is expressed in decibels.

Dynamic Range

Dynamic range is the ratio of the rms value of the full scale to the total rms noise measured. The value for dynamic range is expressed in decibels. It is measured with a signal at -60 dBFS so that it includes all noise sources and DNL artifacts.

Signal-to-Noise Ratio (SNR)

SNR is the ratio of the rms value of the actual input signal to the rms sum of all other spectral components below the Nyquist frequency, excluding harmonics and dc. The value for SNR is expressed in decibels.

Signal-to-Noise-and-Distortion Ratio (SINAD)

SINAD is the ratio of the rms value of the actual input signal to the rms sum of all other spectral components that are less than the Nyquist frequency, including harmonics but excluding dc. The value of SINAD is expressed in decibels.

Aperture Delay

Aperture delay is the measure of the acquisition performance and is the time between the rising edge of the CNV input and when the input signal is held for a conversion.

Transient Response

Transient response is the time required for the ADC to acquire a full-scale input step to ± 0.5 LSB accuracy.

Power Supply Rejection Ratio (PSRR)

PSRR is the ratio of the power in the ADC output at the frequency, f , to the power of a 200 mV p-p sine wave applied to the ADC VDD supply of frequency, f .

$$PSRR \text{ (dB)} = 10 \log(P_{VDD_IN}/P_{ADC_OUT}) \quad (2)$$

where:

P_{VDD_IN} is the power at the frequency, f , at the VDD pin.

P_{ADC_OUT} is the power at the frequency, f , in the ADC output.

THEORY OF OPERATION

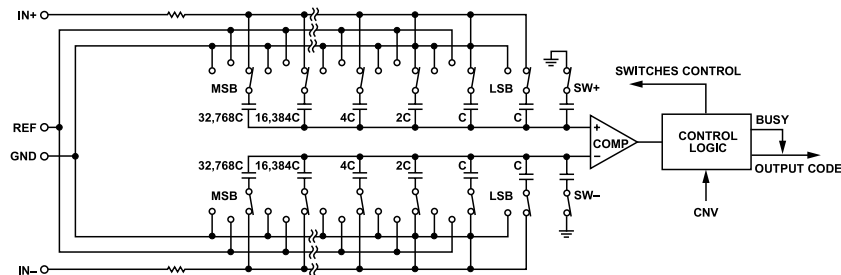

Figure 36. ADC Simplified Schematic

CIRCUIT INFORMATION

The AD4000/AD4004/AD4008 are high speed, low power, single-supply, precise, 16-bit pseudo differential ADCs based on a SAR architecture.

The AD4000 is capable of converting 2,000,000 samples per second (2 MSPS), the AD4004 is capable of converting 1,000,000 samples per second (1 MSPS), and the AD4008 is capable of converting 500,000 samples per second (500 kSPS). The power consumption of the AD4000/AD4004/AD4008 scales with throughput because they power down in between conversions. For example, when operating at 10 kSPS, the devices typically consume 70 μ W, making them ideal for battery-powered applications. The AD4000/AD4004/AD4008 also have a valid first conversion after being powered down for long periods, which can further reduce power consumed in applications in which the ADC does not need to be constantly converting.

The AD4000/AD4004/AD4008 provide the user with an on-chip track-and-hold and do not exhibit any pipeline delay or latency, making them ideal for multiplexed applications.

The AD4000/AD4004/AD4008 incorporate a multitude of unique easy to use features that result in a lower system power and smaller footprint.

The AD4000/AD4004/AD4008 each have an internal voltage clamp that protects the device from overvoltage damage on the analog inputs.

The analog input incorporates circuitry that reduces the nonlinear charge kickback seen from a typical switched capacitor SAR input. This reduction in kickback, combined with a longer acquisition phase allows the use of lower bandwidth and lower power amplifiers as drivers. This combination has the additional benefit of allowing a larger resistor value in the input RC filter and a corresponding smaller capacitor, which results in a smaller RC load for the amplifier, improving stability and power dissipation.

High-Z mode can be enabled via the SPI interface by programming a register bit (see Table 12). When high-Z mode is enabled, the ADC input has a low input charging current at low input signal frequencies as well as improved distortion over a wide frequency range up to 100 kHz. For frequencies greater than 100 kHz and multiplexing functionality, disable high-Z mode.

For single-supply applications, a span compression feature creates additional headroom and footroom for the driving amplifier to access the full range of the ADC.

The fast conversion time of the AD4000/AD4004/AD4008, along with turbo mode, allows low clock rates to read back conversions, even when running at their respective maximum throughput rates. Note that, for the AD4000, the full throughput rate of 2 MSPS can be achieved only with turbo mode enabled.

The AD4000/AD4004/AD4008 can interface with any 1.8 V to 5 V digital logic family. These devices are available in a 10-lead MSOP or a tiny 10-lead LFCSP that allows space savings and flexible configurations.

The AD4000/AD4004/AD4008 are pin for pin compatible with some of the 14-/16-/18-/20-bit precision SAR ADCs listed in Table 8.

Table 8. MSOP and LFCSP 14-/16-/18-/20-Bit Precision SAR ADCs

Bits	400 kSPS to			
	100 kSPS	250 kSPS	500 kSPS	≥ 1000 kSPS
20 ¹	Not applicable	Not applicable	AD4022 ²	AD4020 ² , AD4021 ²
18 ¹	AD7989-1 ²	AD7691 ²	AD4011 ² , AD7690 ² , AD7989-5 ²	AD4003 ² , AD4007 ² , AD7982 ² , AD7984 ²
18 ³			AD4010 ²	AD4002 ² , AD4006 ²
16 ¹	AD7684	AD7687 ²	AD7688 ² , AD7693 ² , AD7916 ²	AD4001 ² , AD4005 ² , AD7915 ²
16 ³	AD7680, AD7683, AD7988-1 ²	AD7685 ² , AD7694	AD4008 ² , AD7686 ² , AD7988-5 ²	AD4000 ² , AD4004 ² , AD7980 ² , AD7983 ²
14 ³	AD7940	AD7942 ²	AD7946 ²	Not applicable

¹ True differential.

² Pin for pin compatible.

³ Pseudo differential.

THEORY OF OPERATION

CONVERTER OPERATION

The AD4000/AD4004/AD4008 are SAR-based ADCs using a charge redistribution sampling digital-to-analog converter (DAC). Figure 36 shows the simplified schematic of the ADC. The capacitive DAC consists of two identical arrays of 16 binary weighted capacitors, that are connected to the comparator inputs.

During the acquisition phase, terminals of the array tied to the input of the comparator are connected to ground via the SW+ and SW- switches (see Figure 36). All independent switches connect the other terminal of each capacitor to the analog inputs. The capacitor arrays are used as sampling capacitors and acquire the analog signal on the IN+ and IN- inputs.

When the acquisition phase is complete and the CNV input goes high, a conversion phase initiates. When the conversion phase begins, SW+ and SW- are opened first. The two capacitor arrays are then disconnected from the inputs and connected to the GND input. The differential voltage between the IN+ and IN- inputs captured at the end of the acquisition phase is applied to the comparator inputs, causing the comparator to become unbalanced. By switching each element of the capacitor array between GND and V_{REF} , the comparator input varies by binary weighted voltage steps ($V_{REF}/2, V_{REF}/4, \dots, V_{REF}/65,536$). The control logic toggles these switches, starting with the MSB, to bring the comparator back into a balanced condition. After the process completes, the control logic generates the ADC output code and a busy signal indicator.

Table 9. Output Codes and Ideal Input Voltages

Description	Analog Input, $V_{REF} = 5\text{ V}$	$V_{REF} = 5\text{ V}$ with Span Compression Enabled (V)	Digital Output Code
FSR - 1 LSB	4.999924 V	4.499939	0xFFFF ¹
Midscale + 1 LSB	2.500076 V	2.500061	0x8001
Midscale	2.5 V	2.5	0x8000
Midscale - 1 LSB	2.499924 V	2.499939	0x7FFF
-FSR + 1 LSB	76.3 μV	0.50006103	0x0001
-FSR	0 V	0.5	0x0000 ²

¹ This output code is also the code for an overranged analog input ($V_{IN+} - V_{IN-}$ above V_{REF} with span compression disabled and above $0.9 \times V_{REF}$ with span compression enabled).

² This output code is also the code for an underranged analog input ($V_{IN+} - V_{IN-}$ below 0 V with span compression disabled and below $0.1 \times V_{REF}$ with span compression enabled).

Because the AD4000, the AD4004, and the AD4008 have on-board conversion clocks, the serial clock, SCK, is not required for the conversion process.

TRANSFER FUNCTIONS

The ideal transfer characteristics for the AD4000/AD4004/AD4008 are shown in Figure 37 and Table 9.

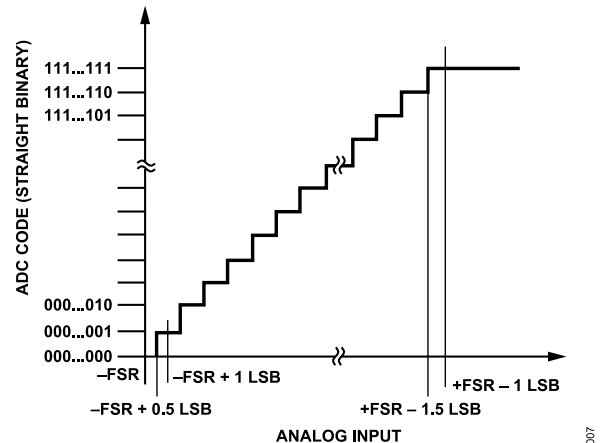

Figure 37. ADC Ideal Transfer Function (FSR Is Full-Scale Range)

APPLICATIONS INFORMATION

TYPICAL APPLICATION DIAGRAMS

Figure 38 shows an example of the recommended connection diagram for the AD4000/AD4004/AD4008 when multiple supplies, V+ and V-, are available. This configuration is used for optimal performance because the amplifier supplies can be selected to allow the maximum signal range (see Figure 38 for the range).

Figure 39 shows a recommended connection diagram when using a single-supply system. This setup is preferable when only a limited number of rails are available in the system and power dissipation is of critical importance.

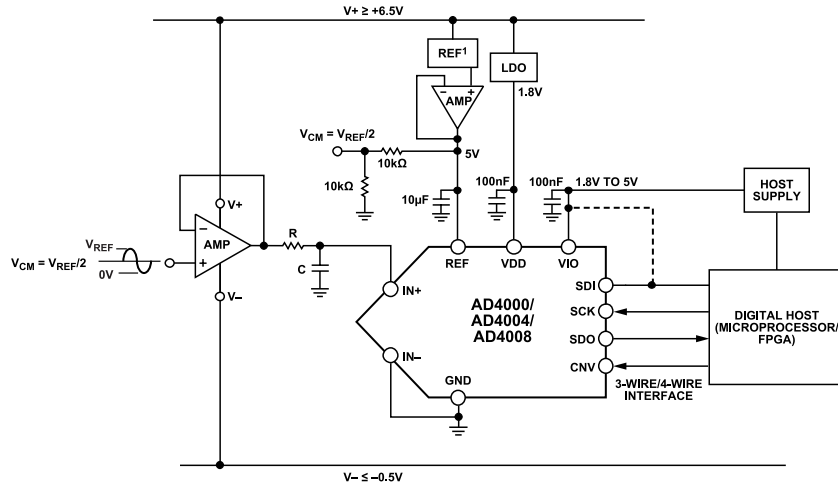
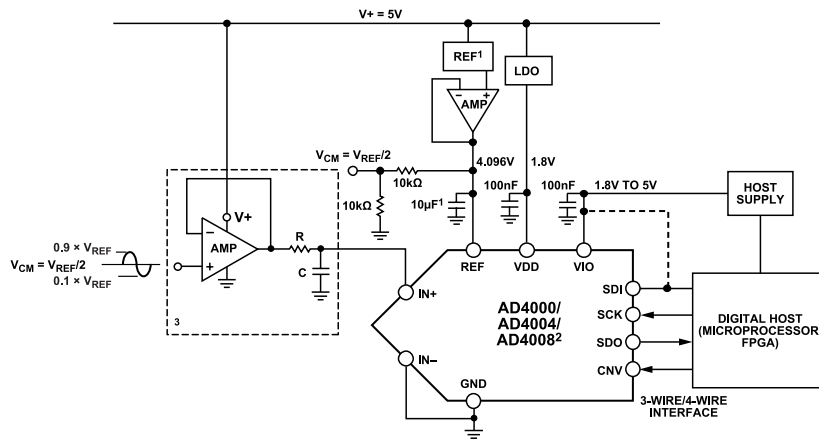

Figure 38. Typical Application Diagram with Multiple Supplies



¹SEE THE VOLTAGE REFERENCE INPUT SECTION FOR REFERENCE SELECTION. C_{REF} IS USUALLY A 10μF CERAMIC CAPACITOR (X7R).
²SPAN COMPRESSION MODE ENABLED.
³SEE TABLE 10 FOR RC FILTER AND AMPLIFIER SELECTION.

Figure 39. Typical Application Diagram with a Single Supply

APPLICATIONS INFORMATION

ANALOG INPUTS

Figure 40 shows an equivalent circuit of the analog input structure, including the overvoltage clamp of the AD4000/AD4004/AD4008.

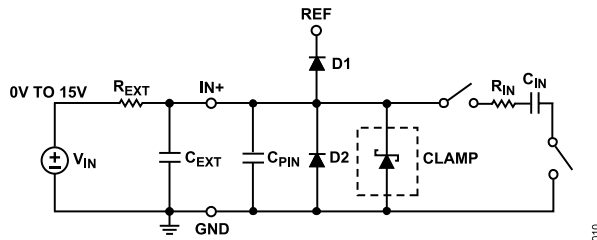

Figure 40. Equivalent Analog Input Circuit

Input Overvoltage Clamp Circuit

Most ADC analog inputs, IN+ and IN-, have no overvoltage protection circuitry apart from ESD protection diodes. During an overvoltage event, an ESD protection diode from an analog input pin (IN+ or IN-) to REF forward biases and shorts the input pin to REF, potentially overloading the reference or damaging the device. The AD4000/AD4004/AD4008 internal overvoltage clamp circuit, with a larger external resistor ($R_{EXT} = 200 \Omega$), eliminates the need for external protection diodes and protects the ADC inputs against dc overvoltages.

In applications where the amplifier rails are greater than V_{REF} and less than ground, it is possible for the output to exceed the input voltage range (specified in Table 1) of the device. In this case, the AD4000/AD4004/AD4008 internal overvoltage clamp circuit ensures that the voltage on the input pin does not exceed $V_{REF} + 0.4$ V and prevents damage to the device by clamping the input voltage in a safe operating range and avoiding disturbance of the reference, which is particularly important for systems that share the reference among multiple ADCs.

If the analog input exceeds the reference voltage by 0.4 V, the internal clamp circuit turns on and the current flows through the clamp into ground, preventing the input from rising further and potentially causing damage to the device. The clamp turns on before D1 (see Figure 40) and can sink up to 50 mA of current.

When the clamp is active, it sets the overvoltage (\overline{OV}) clamp flag bit in the configuration register that is accessed with a 16-bit SPI read command or via the \overline{OV} in the status bits. The \overline{OV} clamp flag gives an indication of overvoltage condition when it is set to 0. The \overline{OV} clamp flag is a read only sticky bit, and is cleared only if the register is read while the overvoltage condition is no longer present.

The clamp circuit does not dissipate static power in the off state. Note that the clamp cannot sustain the overvoltage condition for an indefinite amount of time.

The external RC filter, formed by the R_{EXT} resistor and the C_{EXT} capacitor (see Figure 40), is usually present at the ADC input to band limit the input signal. During an overvoltage event, excessive voltage is dropped across R_{EXT} , and R_{EXT} becomes part of a protection circuit. The R_{EXT} value can vary from 200 Ω to 20 k Ω for 15 V protection. The C_{EXT} value can be as low as 100 pF for correct operation of the clamp. See Table 1 for input overvoltage clamp specifications.

The analog input structure allows the sampling of the true differential signal between IN+ and IN-. Signals common to both inputs are rejected when using these differential inputs. Ground potential differences between the sensor and the local ADC ground are eliminated when using IN- to sense a remote signal ground.

Switched Capacitor Input

During the acquisition phase, the impedance of the analog inputs (IN+ or IN-) can be modeled as a parallel combination of Capacitor C_{PIN} and the network formed by the series connection of R_{IN} and C_{IN} . C_{PIN} is primarily the pin capacitance. R_{IN} is typically 400 Ω and is a lumped component composed of serial resistors and the on resistance of the switches. C_{IN} is typically 40 pF and is mainly the ADC sampling capacitor.

During the conversion phase, where the switches are open, the input impedance is limited to C_{PIN} . R_{IN} and C_{IN} make a single-pole, low-pass filter that reduces undesirable aliasing effects and limits noise.

RC Filter Values

The RC filter value (represented by R and C in Figure 38 and Figure 39) and driving amplifier can be selected depending on the input signal bandwidth of interest at the full throughput. Lower input signal bandwidth means that the RC cutoff can be lower, thereby reducing noise into the converter. For optimum performance at various throughputs, use the recommended RC values (200 Ω , 180 pF) and the ADA4805-1.

The RC values shown in Table 10 are chosen for ease of drive considerations and greater ADC input protection. The combination of a large R value (200 Ω) and small C value results in a reduced dynamic load for the amplifier to drive. The smaller value of C means fewer stability and phase margin concerns with the amplifier. The large value of R limits the current into the ADC input when the amplifier output exceeds the ADC input range.

APPLICATIONS INFORMATION

Table 10. RC Filter and Amplifier Selection for Various Input Bandwidths

Input Signal Bandwidth (kHz)	ADC	R (Ω)	C (pF)	Recommended Amplifier	Precision ADC Driver Tool
<10	AD4000 (2 MSPS)	200	180	ADA4805-1	ADC Driver Tool Example
	AD4004 (1 MSPS)	680	180	ADA4805-1	ADC Driver Tool Example
	AD4008 (500 kSPS)	680	180	ADA4805-1	ADC Driver Tool Example
	AD4000 (2 MSPS)	390	180	ADA4077-1 ¹	ADC Driver Tool Example
	AD4004 (1 MSPS)	680	180	ADA4077-1 ¹	ADC Driver Tool Example
	AD4008 (500 kSPS)	680	470	ADA4077-1 ¹	ADC Driver Tool Example
	AD4000 (2 MSPS)	390	180	ADA4610-1 ¹	ADC Driver Tool Example
	AD4004 (1 MSPS)	680	180	ADA4610-1 ¹	ADC Driver Tool Example
<100	AD4000 (2 MSPS)	200	180	ADA4805-1	ADC Driver Tool Example
	AD4004 (1 MSPS)	200	360	ADA4805-1	ADC Driver Tool Example
	AD4008 (500 kSPS)	200	360	ADA4805-1	ADC Driver Tool Example
≥100	AD4000 (2 MSPS)	120	180	ADA4897-1	ADC Driver Tool Example
	AD4004 (1 MSPS)	200	180	ADA4897-1	ADC Driver Tool Example
	AD4008 (500 kSPS)	120	180	ADA4897-1	ADC Driver Tool Example
Multiplexed	AD4000 (2 MSPS)	100	180	ADA4897-1	ADC Driver Tool Example
	AD4004 (1 MSPS)	200	180	ADA4897-1	ADC Driver Tool Example
	AD4008 (500 kSPS)	200	180	ADA4897-1	ADC Driver Tool Example

¹ See the [High-Z Mode](#) section.

DRIVER AMPLIFIER CHOICE

Although the AD4000/AD4004/AD4008 are easy to drive, the driver amplifier must meet the following requirements:

- ▶ The noise generated by the driver amplifier must be kept low enough to preserve the SNR and transition noise performance of the AD4000/AD4004/AD4008. The noise from the driver is filtered by the single-pole, low-pass filter of the analog input circuit made by R_{IN} and C_{IN} , or by the external filter, if one is used. Because the typical noise of the AD4000/AD4004/AD4008 is 37 μ V rms, the SNR degradation due to the amplifier is the following:

$$SNR_{LOSS} = 20 \log \left(\frac{37 \mu V}{\sqrt{(37 \mu V)^2 + \frac{\pi}{2} f - 3 db (NeN)^2}} \right) \quad (3)$$

where:

$f_{-3 dB}$ is the input bandwidth, in megahertz, of the AD4000/AD4004/AD4008 (10 MHz) or the cutoff frequency of the input filter, if one is used.

N is the noise gain of the amplifier (for example, 1 in buffer configuration).

e_N is the equivalent input noise voltage of the operational amplifier, in nV/ \sqrt{Hz} .

- ▶ For ac applications, the driver must have a THD performance commensurate with the AD4000/AD4004/AD4008.
- ▶ For multichannel multiplexed applications, the driver amplifier and the analog input circuit of the AD4000/AD4004/AD4008 must

settle for a full-scale step onto the capacitor array at a 16-bit level (0.0001525%, 15.25 ppm). In amplifier data sheets, settling at 0.1% to 0.01% is more commonly specified. Settling at 0.1% to 0.01% may differ significantly from the settling time at a 16-bit level and must be verified prior to driver selection.

The Precision ADC Driver Tool can be used to model the settling behavior and estimate the ac performance of the AD4000/AD4004/AD4008 with a selected driver amplifier and RC filter. Once the Precision ADC Driver Tool has modelled a specific circuit, the circuit can be exported for simulation in [LTspice](#).

High Frequency Input Signals

The AD4000/AD4004/AD4008 ac performance over a wide input frequency range is shown in [Figure 16](#) and [Figure 19](#). Unlike other traditional SAR ADCs, the AD4000/AD4004/AD4008 maintain exceptional ac performance for input frequencies up to the Nyquist frequency with minimal performance degradation. Note that the input frequency is limited to the Nyquist frequency of the sample rate in use.

Multiplexed Applications

The AD4000/AD4004/AD4008 significantly reduce system complexity for multiplexed applications that require superior performance in terms of noise, power, and throughput. [Figure 41](#) shows a simplified block diagram of a multiplexed data acquisition system including a multiplexer, an ADC driver, and the precision SAR ADC.

APPLICATIONS INFORMATION

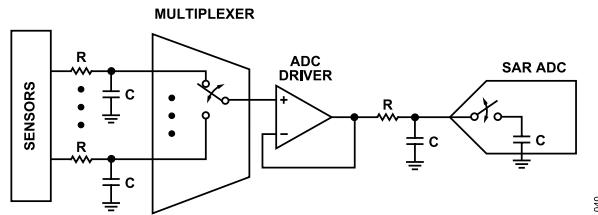

Figure 41. Multiplexed Data Acquisition Signal Chain Using the AD4000/AD4004/AD4008

Switching multiplexer channels typically results in large voltage steps at the ADC inputs. To ensure an accurate conversion result, the step must be given adequate time to settle before the ADC samples its inputs (on the rising edge of CNV). The settling time error is dependent on the drive circuitry (multiplexer and ADC driver), RC filter values, and the time when the multiplexer channels are switched. Switch the multiplexer channels immediately after t_{QUIET1} has elapsed from the start of the conversion to maximize settling time and to prevent corruption of the conversion result. To avoid conversion corruption, do not switch the channels during the t_{QUIET1} time. If the analog inputs are multiplexed during the quiet conversion time (t_{QUIET1}), the current conversion is possibly corrupted.

EASE OF DRIVE FEATURES

Input Span Compression

In single-supply applications, it is recommended to use the full range of the ADC. However, the amplifier can have some headroom and footroom requirements, which can be a problem, even if it is a rail-to-rail input and output amplifier. The AD4000/AD4004/AD4008 include a span compression feature, which increases the headroom and footroom available to the amplifier by reducing the input range by 10% from the top and bottom of the range while still accessing all available ADC codes (see Figure 42). The SNR decreases by approximately 1.9 dB ($20 \times \log(8/10)$) for the reduced input range when span compression is enabled. Span compression is disabled by default but is enabled by writing to the relevant register bit (see the Digital Interface section).

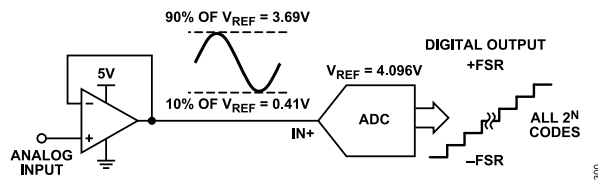

Figure 42. Span Compression

High-Z Mode

The AD4000/AD4004/AD4008 incorporate high-Z mode, which reduces the nonlinear charge kickback when the capacitor DAC switches back to the input at the start of acquisition. Figure 27 shows the analog input current of the AD4000/AD4004/AD4008 with high-Z mode enabled and disabled. The low input current

makes the ADC easier to drive than the traditional SAR ADCs, even with high-Z mode disabled. The input current reduces further to submicroampere range when high-Z mode is enabled. High-Z mode is disabled by default but can be enabled by writing to the configuration register (see Table 12). Disable high-Z mode for input frequencies above 100 kHz or when multiplexing.

To achieve the optimal data sheet performance from traditional high resolution precision SAR ADCs, system designers must often use a dedicated, high power, high speed amplifier to drive the switched capacitor SAR ADC inputs. High-Z mode allows a choice of lower power and lower bandwidth precision amplifiers with a lower RC filter cutoff to drive the ADC, removing the need for dedicated high speed ADC drivers, which saves system power, size, and cost in precision, low bandwidth applications. High-Z mode allows the amplifier and RC filter in front of the ADC to be chosen based on the signal bandwidth of interest, rather than the settling requirements of the switched capacitor SAR ADC inputs. High-Z mode also improves THD performance and reduces analog input current for input signals up to 100 kHz.

Additionally, the AD4000/AD4004/AD4008 can be driven with a much higher source impedance than traditional SARs, which means the resistor in the RC filter can have a value 10 times larger than previous SAR designs and with high-Z mode enabled, can tolerate even greater impedance. Figure 25 shows the THD performance for various source impedances with high-Z mode disabled and enabled.

Figure 43 and Figure 44 show the AD4000 SNR and THD performance using the ADA4077-1 (supply current per amplifier (I_{SY}) = 400 μA) and ADA4610-1 (I_{SY} = 1.50 mA) precision amplifiers when driving the AD4000 at full throughput for high-Z mode both enabled and disabled with various RC filter values. These amplifiers achieve 91 dB to 92 dB typical SNR and close to -100 dB typical THD with high-Z enabled for a 2.27 MHz RC bandwidth. The THD is improved by approximately 5 dB with high-Z mode enabled, even for large R values greater than 200 Ω . SNR maintains close to 85 dB, even with a low RC filter cutoff. The ADA4077-1 and ADA4610-1 data sheets of the selected precision amplifiers (see Figure 43 and Figure 44) show that their own noise and distortion performance dominates the SNR and THD specification at a certain input frequency.

When high-Z mode is enabled, the ADC consumes approximately 1 mW per MSPS of extra power. However, this additional power is still significantly lower than using dedicated ADC drivers like the ADA4807-1.

APPLICATIONS INFORMATION

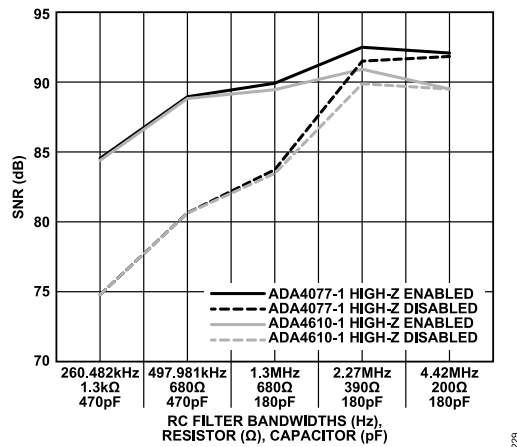

Figure 43. SNR vs. RC Filter Bandwidths for Various Precision ADC Drivers for the AD4000, $f_{IN} = 1$ kHz (See the [Typical Performance Characteristics Section for Operating Conditions](#))

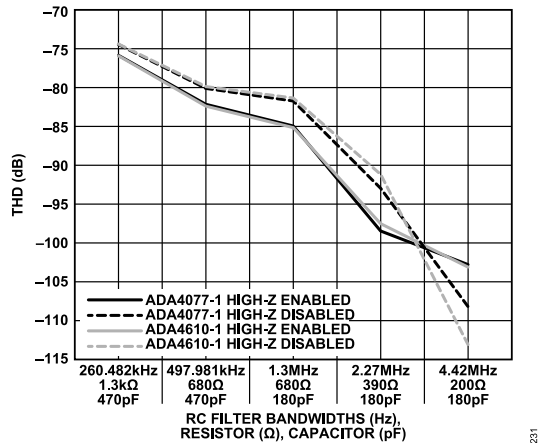

Figure 44. THD vs. RC Filter Bandwidths for Various Precision ADC Drivers for the AD4000, $f_{IN} = 1$ kHz (See the [Typical Performance Characteristics Section for Operating Conditions](#))

Long Acquisition Phase

The AD4000/AD4004/AD4008 also feature a fast conversion time of 290 ns, which results in a long acquisition phase. The acquisition is further extended by a key feature of the AD4000/AD4004/AD4008: the ADC returns to the acquisition phase typically 100 ns before the end of the conversion. This feature provides an even longer time for the ADC to acquire the new input voltage. A longer acquisition phase reduces the settling requirement on the driving amplifier, and a lower power and lower bandwidth amplifier can be chosen. The longer acquisition phase means that a lower RC filter (represented by R and C in [Figure 38](#) and [Figure 39](#)) cutoff can be used, which means a noisier amplifier can also be tolerated. A larger value of R can be used in the RC filter with a corresponding smaller value of C, reducing amplifier stability concerns without affecting distortion performance significantly. A larger value of R also results in reduced dynamic power dissipation in the amplifier.

See [Table 10](#) for details on setting the RC filter bandwidth and choosing a suitable amplifier.

VOLTAGE REFERENCE INPUT

A 10 μF (X7R, 0805 size) ceramic chip capacitor is appropriate for the optimum performance of the reference input.

For higher performance and lower drift, use a reference such as the [ADR4550](#). Using a low power reference such as the [ADR3450](#) can result in a slight decrease in the noise performance. It is recommended to use a reference buffer, such as the [ADA4807-1](#), between the reference and the ADC reference input. It is important to consider the optimum capacitance necessary to keep the reference buffer stable as well as to meet the minimum ADC requirement stated previously in this section (that is, a 10 μF ceramic chip capacitor, C_{REF}).

POWER SUPPLY

The AD4000/AD4004/AD4008 use two power supply pins: a core supply (VDD) and a digital input/output interface supply (VIO). VIO allows direct interface with any logic between 1.8 V and 5.5 V. To reduce the number of supplies needed, VIO and VDD can be tied together for 1.8 V operation. The [ADP7118](#) low noise, CMOS, low dropout (LDO) linear regulator is recommended to power the VDD and VIO pins. The AD4000/AD4004/AD4008 are independent of power supply sequencing between VIO and VDD. Additionally, the AD4000/AD4004/AD4008 are insensitive to power supply variations over a wide frequency range, as shown in [Figure 31](#).

The AD4000/AD4004/AD4008 power down automatically at the end of each conversion phase. Therefore, the power scales linearly with the sampling rate. This feature makes the device ideal for low sampling rates (even a few samples per second) and battery-powered applications. [Figure 33](#) shows the AD4000/AD4004/AD4008 total power dissipation and individual power dissipation for each rail.

DIGITAL INTERFACE

The AD4000/AD4004/AD4008 digital interface is used to perform analog to digital conversions and to enable and disable various features. The AD4000/AD4004/AD4008 are compatible with SPI, QSPI™, and MICROWIRE® digital hosts and DSPs. SCK must be set with clock polarity (CPOL) = clock phase (CPHA) = 0. A 3-wire interface using the CNV, SCK, and SDO signals minimizes wiring connections, which is useful in applications with digital isolation. A 4-wire interface using the SDI, CNV, SCK, and SDO signals allows CNV, which initiates the conversions, to be independent of the readback timing (SDI). This interface is useful in low jitter sampling or simultaneous sampling applications. In either 3-wire or 4-wire $\overline{\text{CS}}$ mode, a busy signal can be enabled to indicate when the conversion result is ready. The busy signal acts as an interrupt to the digital host to initiate data readback.

The AD4000/AD4004/AD4008 digital interface also supports daisy-chaining multiple devices to read back results from multiple ADCs over a single SPI bus.

APPLICATIONS INFORMATION

Timing diagrams and explanations for each digital interface mode are given in the [CS Mode, 3-Wire Turbo Mode](#) section through the [Daisy-Chain Mode](#) section.

Turbo mode allows the use of slower SPI clock rates by extending the amount of time available to clock out conversion results. Turbo mode is enabled by setting the Turbo Mode Enable field to 1 in the configuration register (see [Table 12](#)) and replaces the busy indicator feature when enabled. The maximum throughput of 2 MSPS for the AD4000 can be achieved only with turbo mode enabled and a minimum SCK frequency of 70 MHz (see the [CS Mode, 3-Wire Turbo Mode](#) section). See the [CS Mode, 4-Wire Turbo Mode](#) for descriptions of turbo mode operation.

Status bits can also be clocked out at the end of the conversion data if the status bits are enabled in the configuration register (see the [Status Bits](#) section).

For isolated systems, the [ADuM141D](#) is recommended, which can support the 70 MHz SCK frequency required to run the AD4000 at its full throughput of 2 MSPS.

Table 12. AD4000/AD4004/AD4008 Configuration Register

Bits	Bit Name	Description	Reset	Access ¹
[7:5]	Reserved	Reserved memory.	0x0	R
4	Status bits enable	Enables status bits (see the Status Bits section). 0: disables status bits. 1: enables status bits.	0x0	R/W
3	Span compression enable	Enables span compression (see the Input Span Compression section). 0: disables span compression. 1: enables span compression.	0x0	R/W
2	High-Z mode enable	Enables high-Z mode (see the High-Z Mode section). 0: disables high-Z mode. 1: enables high-Z mode.	0x0	R/W
1	Turbo mode enable	Enables turbo mode. 0: disables turbo mode. 1: enables turbo mode.	0x0	R/W
0	\overline{OV} clamp flag	Indicates an overvoltage event triggered the input overvoltage clamp circuit (see the Input Overvoltage Clamp Circuit section). This bit is sticky, and clears only when read after the overvoltage event has ended. 0: indicates an overvoltage event has occurred. 1: indicates no overvoltage event has occurred.	0x1	R

¹ R stands for read-only and R/W stands for read/write. Read-only bits cannot be updated with a register write operation. Read/write bits can be updated with a register write operation.

The state of SDO on power-up is either low or high-Z, depending on the states of CNV and SDI, as shown in [Table 11](#).

Table 11. State of SDO on Power-Up

CNV	SDI	SDO
0	0	Low
0	1	Low
1	0	Low
1	1	High-Z

Configuration Register Details

The AD4000/AD4004/AD4008 features are controlled via the configuration register. The configuration register is eight bits wide, and contains enable bits for the status bits, span compression, high-Z mode, and turbo mode, as well as an overvoltage detection flag. 16-bit SPI instructions are used to read from and write to the contents in the configuration register. [Table 12](#) shows the locations and descriptions of each field in the configuration register.

APPLICATIONS INFORMATION

Serial Clock Frequency Requirements

The AD4000/AD4004/AD4008 digital interface minimizes the SCK frequency required for reading back conversion results, even when operating at a high throughput. The minimum SCK frequency required for a given application depends on the number of bits being read on SDO, whether turbo mode is enabled or disabled, and the throughput in use.

See [Table 13](#) for several examples of SCK frequency requirements for different throughputs.

Note that the SCK frequency must obey the minimum SCK period specification for the given VIO level and interface mode (see t_{SCK} in [Table 2](#)).

The minimum SCK frequency (f_{SCK}) required to access the conversion result plus status bits when turbo mode is enabled is calculated with the following equation:

$$f_{SCK} > \frac{N_D + N_S}{t_{CYC} - t_{QUIET1} - t_{EN} - t_{QUIET2}} \quad (4)$$

where:

N_D is the ADC resolution (16 bits).

N_S is the number of status bits being accessed.

t_{CYC} , t_{QUIET1} , t_{EN} , and t_{QUIET2} correspond to timing specifications described in [Table 2](#).

The minimum SCK frequency required to access the conversion result plus status bits when turbo mode is not enabled is calculated with the following equation:

$$f_{SCK} > \frac{N_D + N_S}{t_{CYC} - t_{CONV} - t_{EN} - t_{QUIET2}} \quad (5)$$

Where t_{CONV} corresponds to the conversion time, and is described in [Table 2](#).

Table 13. SCK Frequency Requirements for Various Throughputs

CS MODE	Throughput	Minimum SCK Frequency (MHz)
3-Wire and 4-Wire Turbo Modes	2 MSPS (AD4000)	70
	1 MSPS (AD4000/AD4004)	22
	500 kSPS (AD4000/AD4004/AD4008)	10
	100 kSPS (AD4000/AD4004/AD4008)	2
3-Wire and 4-Wire Turbo Modes with Six Status Bits ¹	2 MSPS (AD4000)	93
	1 MSPS (AD4000/AD4004)	30
	500 kSPS (AD4000/AD4004/AD4008)	13
	100 kSPS (AD4000/AD4004/AD4008)	2.5
3-Wire and 4-Wire Modes	1.8 MSPS (AD4000)	100
	1 MSPS (AD4000/AD4004)	27
	500 kSPS (AD4000/AD4004/AD4008)	10
	100 kSPS (AD4000/AD4004/AD4008)	2
3-Wire and 4-Wire Modes with Six Status Bits ¹	1.6 MSPS (AD4000)	95
	1 MSPS (AD4000/AD4004)	37
	500 kSPS (AD4000/AD4004/AD4008)	14
	100 kSPS (AD4000/AD4004/AD4008)	2.5

¹ It is not necessary to clock out all six status bits. The minimum required SCK frequency is reduced when clocking out fewer than six status bits. See the [Serial Clock Frequency Requirements](#) and [Status Bits](#) sections.

APPLICATIONS INFORMATION

REGISTER READ/WRITE FUNCTIONALITY

The AD4000/AD4004/AD4008 configuration register is read from and written to with a 16-bit SPI instruction. The state of the fields in the configuration register determines which of the device features are enabled or disabled (see the [Configuration Register Details](#) section).

The 16-bit SPI instructions consist of the 8-bit register access command (see [Table 14](#)) followed by the register data. When performing register read and write operations, CNV is analogous to a chip select signal, and CNV must be brought low to access the configuration register contents. Data on SDI is latched in on each SCK rising edge. Data is shifted out on SDO on each SCK falling edge. SDO returns to a high impedance state when CNV is brought high.

The first bit read on SDI after a CNV falling edge (represented by \overline{WEN} in [Table 14](#)) must be a 0 to initiate the register access command. The next bit (R/\overline{W}) determines whether the instruction is a write or a read. The following six bits must match the values for Bit 5 through Bit 0 shown in [Table 14](#) to perform the SPI read/write.

When performing a write operation, the new register contents are written over SDI, MSB-first, and the writeable bits in the configuration register are updated after the device receives the full byte. When performing a read operation, the current register contents are shifted out on SDO MSB-first. [Figure 45](#) and [Figure 46](#) show

timing diagrams for register read and write operations when using any of the \overline{CS} modes. [Figure 47](#) shows the timing diagram for performing a register write operation to multiple devices connected in daisy-chain mode.

Register reads are not supported when daisy-chaining multiple devices (see the [Daisy-Chain Mode](#) section). To verify the contents of the configuration register, enable and read the status bits.

The LSB of the configuration register (Bit 0) is a read only bit that allows digital hosts to ensure the desired digital interface mode is selected in the frame immediately following a register write operation. For digital hosts that are limited to 16-bit SPI frames (such as some microcontrollers), set this bit accordingly to ensure SDI is at the desired level on the rising edge of CNV. For example, set this bit to 1 and/or set the idle state of SDI to 1 when using any of the \overline{CS} modes.

SPI write instructions can be performed in the same frame as reading a conversion result. To ensure the conversion is executed correctly, the CNV signal must obey the timing requirements for the selected interface mode.

Table 14. Register Access Command

Bit 7	Bit 6	Bit 5	Bit 4	Bit 3	Bit 2	Bit 1	Bit 0
\overline{WEN}	R/\overline{W}	0	1	0	1	0	0

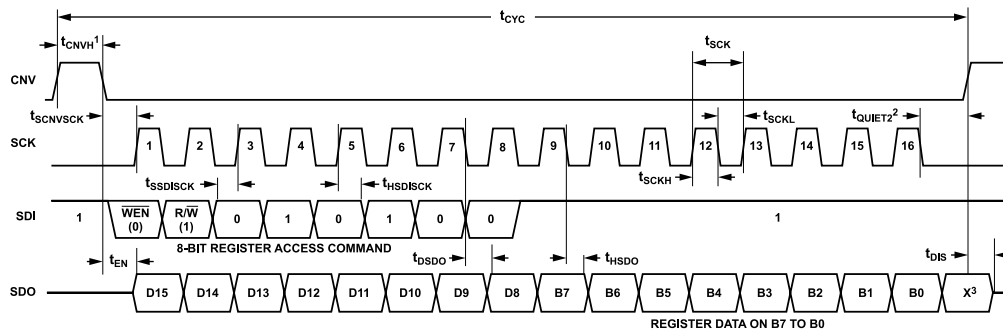

¹THE CNV HIGH TIME MUST FOLLOW THE t_{conv} SPECIFICATION TO GENERATE A VALID CONVERSION RESULT.
²THE SCK FALLING EDGE TO CNV RISING EDGE DELAY MUST FOLLOW THE t_{quiet2} SPECIFICATION TO ENSURE SPECIFIED PERFORMANCE
³X MEANS DON'T CARE

Figure 45. Register Read Timing Diagram

APPLICATIONS INFORMATION

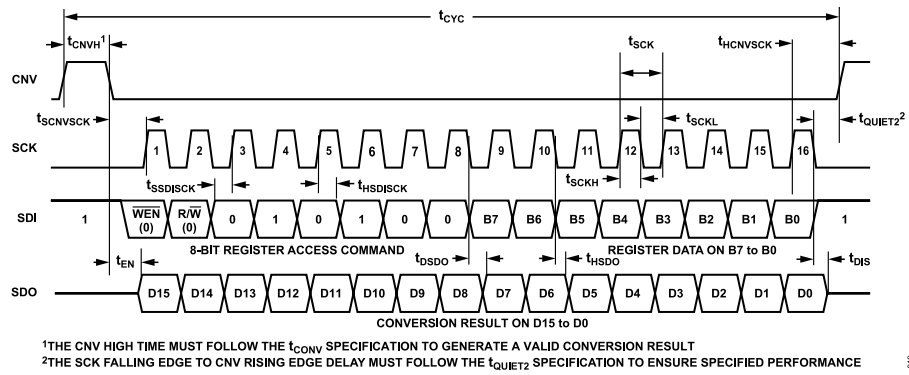

Figure 46. Register Write Timing Diagram

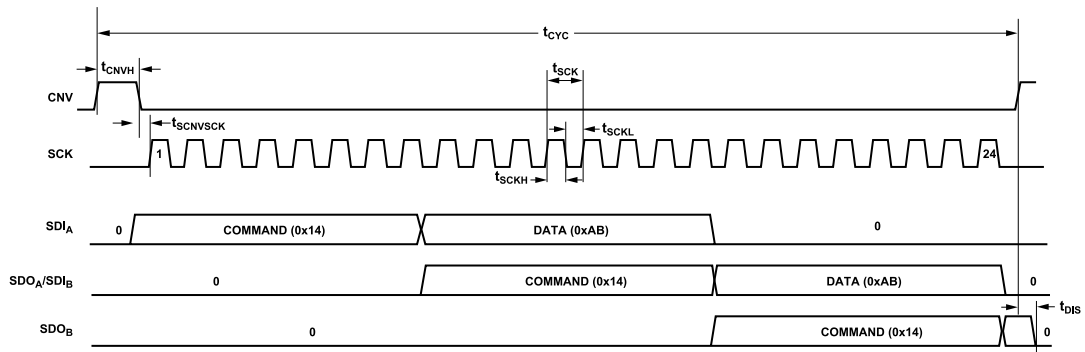

Figure 47. Register Write Timing Diagram, Daisy-Chain Mode

APPLICATIONS INFORMATION

STATUS BITS

A set of six optional status bits can be appended to the end of each conversion result. The status bits allow the digital host to check the state of the input overvoltage protection circuit and verify that the ADC features are configured correctly without interrupting conversions. The status bits are enabled when the Status Bits Enable field in the configuration register is set to 1 (see the [Configuration Register Details](#) section). Table 15 shows a description of each of the status bits.

When enabled, the status bits are clocked out MSB first starting on the SCK falling edge immediately following the LSB of the conversion result. The SDO line returns to high impedance after the sixth status bit is clocked out (except in daisy-chain mode). The user is not required to clock out all status bits to start the next conversion. For example, if the digital host needs to monitor the \overline{OV} clamp flag but also needs to minimize the SCK frequency, the remaining status bits can be ignored to limit the number of SCK pulses required per conversion period. When using multiple

AD4000/AD4004/AD4008 devices in daisy-chain mode, however, all six status bits must be clocked out for each connected device.

Figure 48 shows the serial interface timing for \overline{CS} mode, 3-wire without busy indicator with all six status bits clocked out.

Table 15. Status Bit Descriptions

Bit	Bit Name	Description
5	\overline{OV} clamp flag	Indicates the state of the \overline{OV} clamp flag in the configuration register.
4	Span compression	Indicates the state of the span compression enable field in the configuration register.
3	High-Z mode	Indicates the state of the High-Z mode enable field in the configuration register.
2	Turbo mode	Indicates the state of the turbo mode enable field in the configuration register.
[1:0]	Reserved	Reserved.

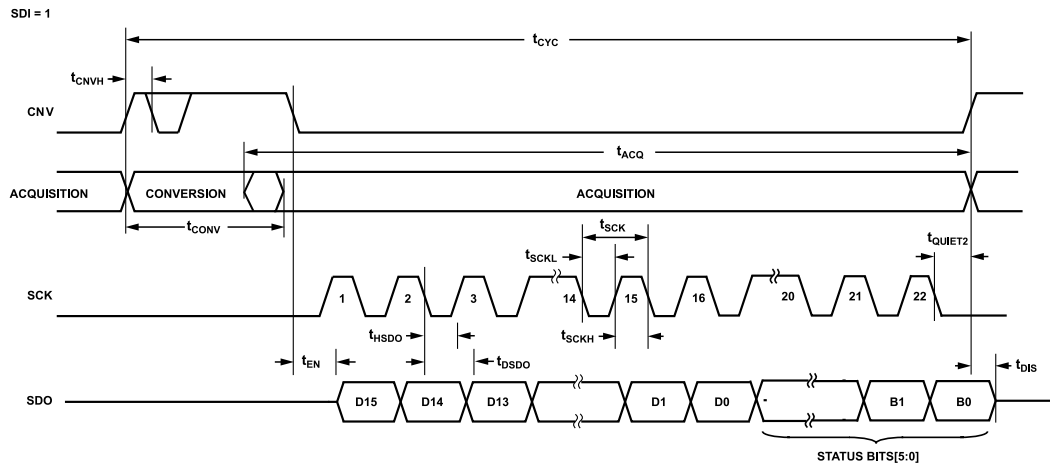

Figure 48. \overline{CS} Mode, 3-Wire Without Busy Indicator Serial Interface Timing Diagram, Including Status Bits

APPLICATIONS INFORMATION

\overline{CS} MODE, 3-WIRE TURBO MODE

This mode is typically used when a single AD4000/AD4004/AD4008 device is connected to an SPI-compatible digital host. Turbo mode allows lower SCK frequencies by increasing the time that the ADC conversion result can be clocked out. The AD4000 can achieve a throughput rate of 2 MSPS only when turbo mode is enabled and using a minimum SCK frequency of 70 MHz (see the [Serial Clock Frequency Requirements](#) section). The connection diagram is shown in [Figure 49](#), and the corresponding timing diagram is shown in [Figure 50](#).

To enable turbo mode, set the Turbo Mode Enable field in the configuration register to 1 (see [Table 12](#)). This mode replaces the 3-wire with busy indicator mode when turbo mode is enabled. Writing to the user configuration register requires SDI to be connected to the digital host (see the [Register Read/Write Functionality](#) section). When turbo mode is enabled, the conversion result read on SDO corresponds to the result of the previous conversion.

When performing conversions in this mode, SDI must be held high. A CNV rising edge initiates a conversion and forces SDO to high

impedance. The user must wait t_{QUIET1} time after the CNV rising edge before bringing CNV low to clock out the previous conversion result. When the conversion is complete (after t_{CONV}), the AD4000/AD4004/AD4008 enter the acquisition phase and power-down.

When CNV goes low, the MSB is output to SDO. The remaining data bits are clocked by subsequent SCK falling edges. The data is valid on both SCK edges. Although the rising edge can capture the data, a digital host using the SCK falling edge allows a faster reading rate, provided it has an acceptable hold time, as dictated by t_{HSDO} (see [Table 2](#)). If the status bits are not enabled, SDO returns to high impedance after the 16th SCK falling edge. If the status bits are enabled, they are shifted out on SDO on the 17th through the 22nd SCK falling edges (see the [Status Bits](#) section). SDO returns to high impedance after the final SCK falling edge, or when CNV goes high (whichever occurs first). The user must also provide a delay of t_{QUIET2} between the final SCK falling edge and the next CNV rising edge to ensure specified performance.

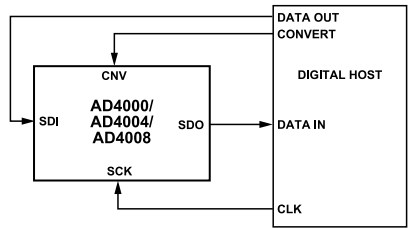

Figure 49. \overline{CS} Mode, 3-Wire Turbo Mode Connection Diagram

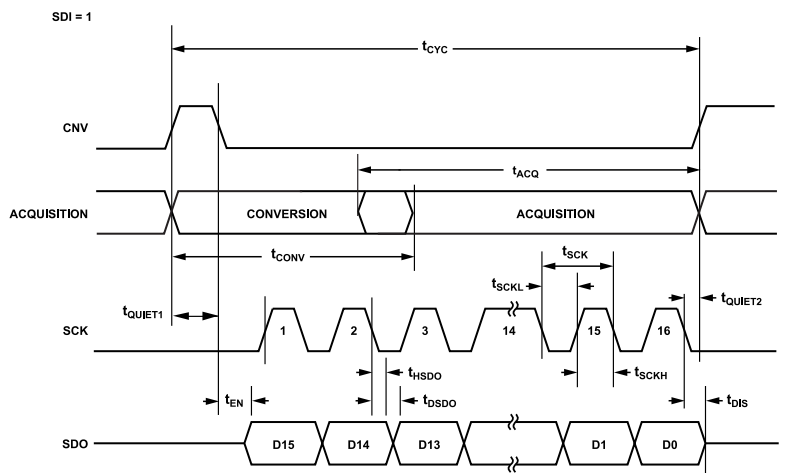

Figure 50. \overline{CS} Mode, 3-Wire Turbo Mode Serial Interface Timing Diagram (Status Bits Not Shown)

APPLICATIONS INFORMATION

\overline{CS} MODE, 3-WIRE WITHOUT BUSY INDICATOR

This mode is typically used when a single AD4000/AD4004/AD4008 device is connected to an SPI-compatible digital host. The connection diagram is shown in Figure 51, and the corresponding timing diagram is shown in Figure 52.

Turbo mode must be disabled to use this mode. To disable turbo mode, set the Turbo Mode Enable field in the configuration register to 0 (see Table 12). Turbo mode is disabled by default.

When performing conversions in this mode, SDI must be held high. SDI can be connected to VIO if register reading and writing is not required. A rising edge on CNV initiates a conversion and forces SDO to high impedance. After a conversion is initiated, it continues until completion irrespective of the state of CNV. This feature can be useful when bringing CNV low to select other SPI devices, such as analog multiplexers. However, CNV must be returned high before the minimum conversion time (t_{CONV}) elapses and then

held high for the maximum possible conversion time to avoid the generation of the busy signal indicator. When the conversion is complete, the AD4000/AD4004/AD4008 enter the acquisition phase and power-down. There must not be any digital activity on SCK during the conversion.

When CNV goes low, the MSB is output onto SDO. The remaining data bits are clocked out on SDO by subsequent SCK falling edges. The data is valid on both SCK edges. Although the rising edge can capture the data, a digital host using the SCK falling edge allows a faster reading rate, provided it has an acceptable hold time, as dictated by t_{HSDO} (see Table 2). If the status bits are not enabled, SDO returns to high impedance after the 16th SCK falling edge. If the status bits are enabled, they are shifted out on SDO on the 17th through the 22nd SCK falling edges (see the Status Bits section). SDO returns to high impedance after the final SCK falling edge, or when CNV goes high (whichever occurs first).

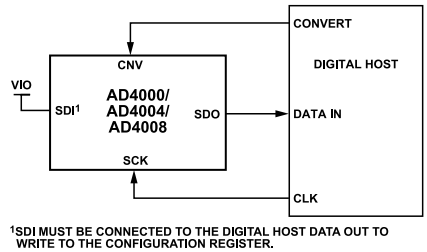

Figure 51. \overline{CS} Mode, 3-Wire Without Busy Indicator Connection Diagram

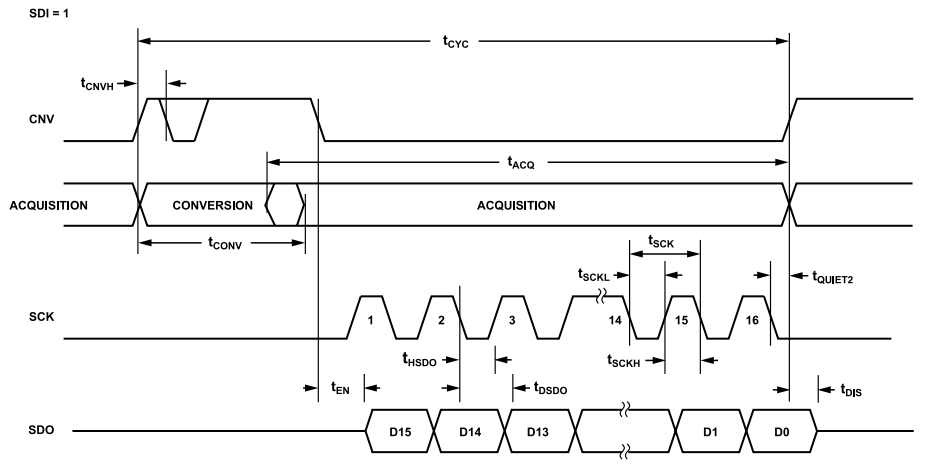

Figure 52. \overline{CS} Mode, 3-Wire Without Busy Indicator Serial Interface Timing Diagram (Status Bits Not Shown)

APPLICATIONS INFORMATION

\overline{CS} MODE, 3-WIRE WITH BUSY INDICATOR

This mode is typically used when a single AD4000/AD4004/AD4008 device is connected to an SPI-compatible digital host with an interrupt input (\overline{IRQ}). The connection diagram is shown in Figure 53, and the corresponding timing diagram is shown in Figure 54.

Turbo mode must be disabled to use this mode. To disable turbo mode, set the Turbo Mode Enable field in the configuration register to 0 (see Table 12). Turbo mode is disabled by default.

When performing conversions in this mode, SDI must be held high. SDI can be connected to VIO if register reading and writing is not required. A rising edge on CNV initiates a conversion and forces SDO to high impedance. SDO remains high impedance until the completion of the conversion, irrespective of the state of CNV. Prior to the minimum conversion time, CNV can select other SPI devices, such as analog multiplexers. However, CNV must be returned low before the minimum conversion time (t_{CONV}) elapses and then held low for the maximum possible conversion time to guarantee the generation of the busy signal indicator. When the conversion is complete, the AD4000/AD4004/AD4008 then enter the acquisition phase and power-down. There must not be any digital activity on the SCK during the conversion.

When the conversion is complete, SDO is driven low. With a pull-up resistor (for example, 1 k Ω) on the SDO line, this transition can be used as an interrupt signal to initiate the data reading controlled by the digital host. The data bits are then clocked out MSB first on SDO by subsequent SCK falling edges. The data is valid on both SCK edges. Although the rising edge can capture the data, a digital host using the SCK falling edge allows a faster reading rate, provided it has an acceptable hold time, as dictated by t_{HSDO} (see Table 2). The conversion result is clocked out on SDO on the first 16 SCK falling edges. If the status bits are enabled, they are clocked out on SDO on the 17th through the 22nd SCK falling edges (see the Status Bits section). SDO returns to high impedance after an optional additional SCK falling edge or the next CNV rising edge (whichever occurs first).

If multiple AD4000/AD4004/AD4008 devices are selected at the same time, the SDO output pin handles this contention without damage or induced latch-up. It is recommended to keep this contention as short as possible to limit extra power dissipation.

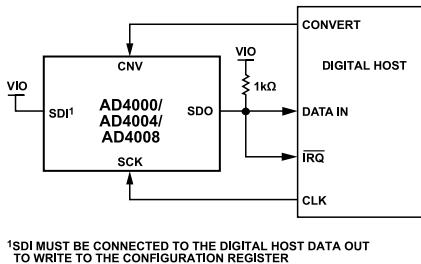

Figure 53. \overline{CS} Mode, 3-Wire with Busy Indicator Connection Diagram

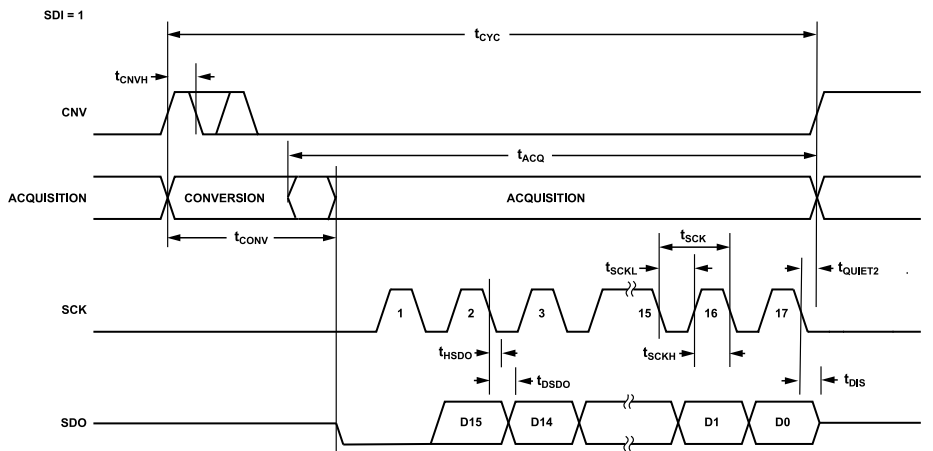

Figure 54. \overline{CS} Mode, 3-Wire with Busy Indicator Serial Interface Timing Diagram (Status Bits Not Shown)

APPLICATIONS INFORMATION

\overline{CS} MODE, 4-WIRE TURBO MODE

This mode is typically used when a single AD4000/AD4004/AD4008 device is connected to an SPI-compatible digital host. Turbo mode allows lower SCK frequencies by increasing the time that the ADC conversion result can be clocked out. The AD4000 can achieve a throughput rate of 2 MSPS only when turbo mode is enabled and using a minimum SCK frequency of 70 MHz (see the [Serial Clock Frequency Requirements](#) section). The connection diagram is shown in [Figure 55](#), and the corresponding timing diagram is shown in [Figure 56](#).

To enable turbo mode, set the Turbo Mode Enable field in the configuration register to 1 (see [Table 12](#)). This mode replaces the 4-wire with busy indicator mode when turbo mode is enabled. The digital host must be able to write data over SDI to perform register reads and writes (see the [Register Read/Write Functionality](#) section). When turbo mode is enabled, the conversion result read on SDO corresponds to the result of the previous conversion.

A rising edge on CNV initiates a conversion and forces SDO to high impedance. CNV must be held high throughout the conversion

and data readback phase. When performing conversions in this mode, SDI must be high during the CNV rising edge. The user must wait t_{QUIET1} time after the CNV rising edge before bringing SDI low to clock out the previous conversion result. When the conversion is complete (after t_{CONV}), the AD4000/AD4004/AD4008 enter the acquisition phase and power-down.

SDI is analogous to a chip select input, and bringing SDI low outputs the MSB of the conversion result on SDO. The remaining data bits are clocked out on SDO by subsequent SCK falling edges. The data is valid on both SCK edges. Although the rising edge can capture the data, a digital host using the SCK falling edge allows a faster reading rate, provided it has an acceptable hold time, as dictated by t_{HSDO} (see [Table 2](#)). The conversion result is clocked out on SDO on the first 16 SCK falling edges. If the status bits are enabled, they are shifted out on SDO on the 17th through the 22nd SCK falling edges (see the [Status Bits](#) section). SDO returns to high impedance after the final SCK falling edge, or when CNV goes high (whichever occurs first). The user must also provide a delay of t_{QUIET2} between the final SCK falling edge and the next CNV rising edge to ensure specified performance.

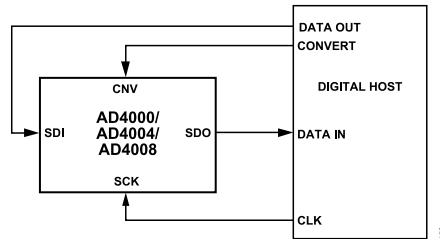

Figure 55. \overline{CS} Mode, 4-Wire Turbo Mode Connection Diagram

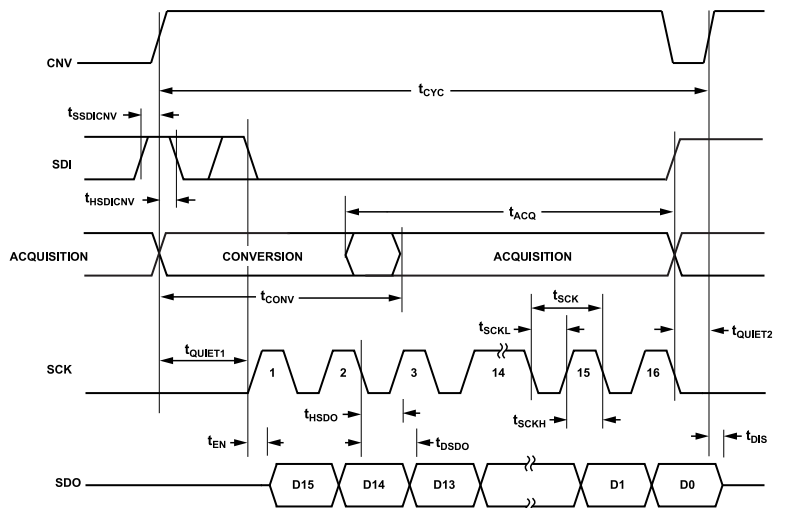

Figure 56. \overline{CS} Mode, 4-Wire Turbo Mode Timing Diagram (Status Bits Not Shown)

APPLICATIONS INFORMATION

\overline{CS} MODE, 4-WIRE WITHOUT BUSY INDICATOR

This mode is typically used when multiple AD4000/AD4004/AD4008 devices are connected to an SPI-compatible digital host. A connection diagram example using two AD4000/AD4004/AD4008 devices is shown in Figure 57, and the corresponding timing diagram is shown in Figure 58.

Turbo mode must be disabled to use this mode. To disable turbo mode, set the Turbo Mode Enable field in the configuration register to 0 (see Table 12). Turbo mode is disabled by default.

A rising edge on CNV initiates a conversion and forces SDO to high impedance. When performing conversions in this mode, SDI must be high during the CNV rising edge. CNV must be held high throughout the conversion and data readback phase. When performing conversions in this mode, SDI must be high during the CNV rising edge. Prior to the minimum conversion time (t_{CONV}), SDI can select other SPI devices, such as analog multiplexers. However, SDI must be returned high before the minimum conversion time elapses and then held high for the maximum possible conversion

time to avoid the generation of the busy signal indicator. When the conversion is complete, the AD4000/AD4004/AD4008 enter the acquisition phase and power-down. There must not be any digital activity on SCK during the conversion.

SDI is analogous to a chip select input, and each ADC result can be read by bringing the corresponding SDI input low. Bringing SDI low on each device outputs the MSB of the conversion result on the corresponding SDO pin. The remaining data bits are clocked out on SDO by subsequent SCK falling edges. The data is valid on both SCK edges. The conversion result is clocked out on SDO on the first 16 SCK falling edges. If the status bits are enabled, they are shifted out on SDO on the 17th through the 22nd SCK falling edges (see the Status Bits section). SDO returns to high impedance after the final SCK falling edge, or when SDI goes high (whichever occurs first). If the SDO of each device is tied together, ensure SDI is only low for one device at a time. The user must also provide a delay of t_{QUIET2} between the final SCK falling edge and the next CNV rising edge to ensure specified performance.

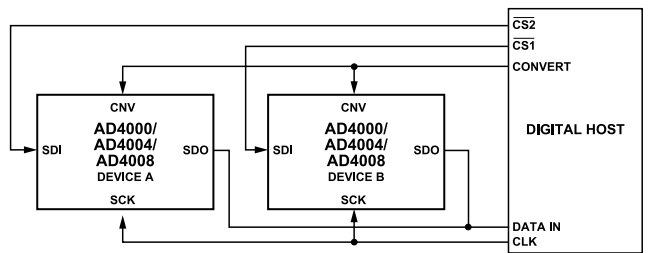

Figure 57. \overline{CS} Mode, 4-Wire Without Busy Indicator Connection Diagram

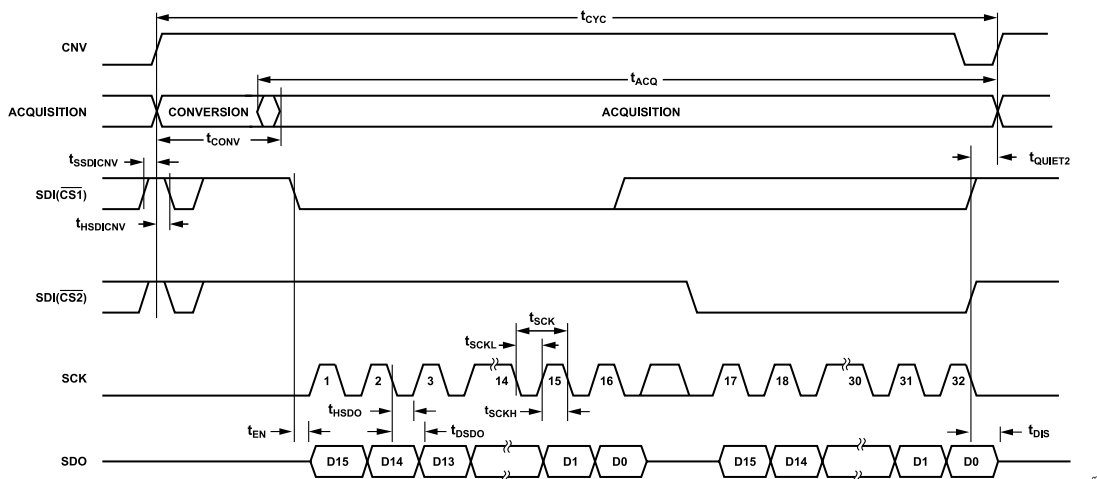

Figure 58. \overline{CS} Mode, 4-Wire Without Busy Indicator Serial Interface Timing Diagram (Status Bits Not Shown)

APPLICATIONS INFORMATION

\overline{CS} MODE, 4-WIRE WITH BUSY INDICATOR

This mode is typically used when a single AD4000/AD4004/AD4008 device is connected to an SPI-compatible digital host with an interrupt input (\overline{IRQ}), and when CNV, which samples the analog input, is required to be independent of the signal used to select the data reading. This independence is particularly important in applications where low jitter on CNV is desired. The connection diagram is shown in Figure 59, and the corresponding timing diagram is shown in Figure 60.

Turbo mode must be disabled to use this mode. To disable turbo mode, set the Turbo Mode Enable field in the configuration register to 0 (see Table 12). Turbo mode is disabled by default.

A rising edge on CNV initiates a conversion and forces SDO to high impedance. When performing conversions in this mode, SDI must be high during the CNV rising edge. CNV must be held high throughout the conversion and data readback phase. When performing conversions in this mode, SDI must be high during the CNV rising edge. Prior to the minimum conversion time (t_{CONV}), SDI can select other SPI devices, such as analog multiplexers. However,

er, SDI must be returned low before the minimum conversion time elapses and then held low for the maximum possible conversion time to guarantee the generation of the busy signal indicator. When the conversion is complete, the AD4000/AD4004/AD4008 enter the acquisition phase and power down. There must not be any digital activity on SCK during the conversion.

When the conversion is complete, SDO is driven low. With a pull-up resistor (for example, 1 k Ω) on the SDO line, this transition can be used as an interrupt signal to initiate the data reading controlled by the digital host. The data bits are then clocked out MSB first on SDO by subsequent SCK falling edges. The data is valid on both SCK edges. Although the rising edge can capture the data, a digital host using the SCK falling edge allows a faster reading rate, provided it has an acceptable hold time, as dictated by t_{HSDO} (see Table 2). The conversion result is clocked out on SDO on the first 16 SCK falling edges. If the status bits are enabled, they are clocked out on SDO on the 17th through the 22nd SCK falling edges (see the Status Bits section). SDO returns to high impedance after an optional additional SCK falling edge or the next CNV rising edge (whichever occurs first).

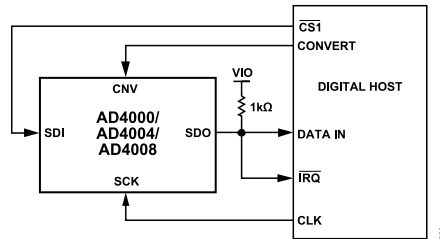

Figure 59. \overline{CS} Mode, 4-Wire with Busy Indicator Connection Diagram

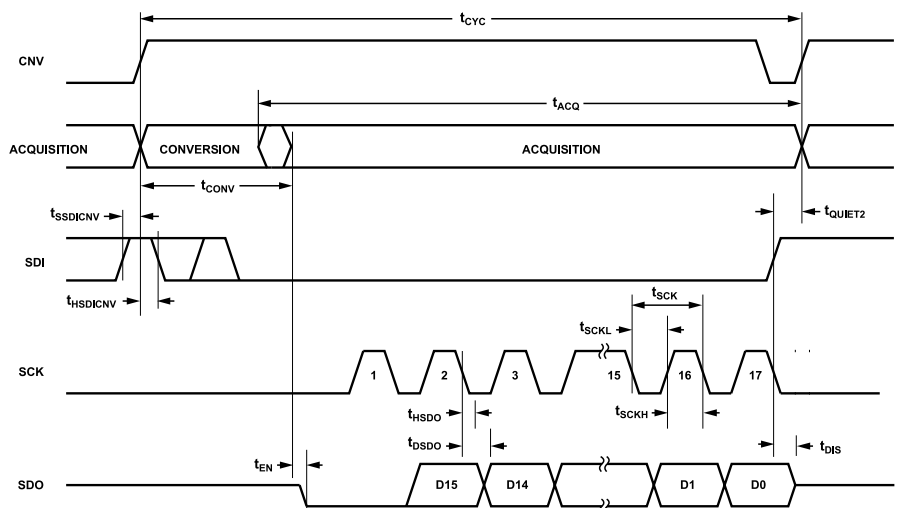

Figure 60. \overline{CS} Mode, 4-Wire with Busy Indicator Serial Interface Timing Diagram (Status Bits Not Shown)

APPLICATIONS INFORMATION

DAISY-CHAIN MODE

Use this mode to daisy-chain multiple AD4000/AD4004/AD4008 devices on a 3-wire or 4-wire serial interface. This feature is useful for reducing component count and wiring connections, such as cases with isolated multiconverter applications or for systems with a limited interfacing capacity. Data readback is analogous to clocking a shift register. A connection diagram example using two AD4000/AD4004/AD4008 devices is shown in Figure 61, and the corresponding timing diagram is shown in Figure 62.

Turbo mode must be disabled to use this mode. To disable turbo mode, set the Turbo Mode Enable field in the configuration register to 0 (see Table 12). Writing to the user configuration register requires SDI to be connected to the digital host (see the Register Read/Write Functionality section). Turbo mode is disabled by default.

When SDI and CNV are low, SDO is driven low. A rising edge on CNV initiates a conversion and SDO remains low. When performing conversions in this mode, SDI and SCK must be low during the CNV rising edge. CNV must be held high throughout the conversion and data readback phase.

When the conversion is complete, the MSB is output onto SDO of each device, and the AD4000/AD4004/AD4008 enter the acquisition phase and power down. The remaining data bits are clocked

out on SDO by subsequent SCK falling edges. For each ADC, SDI feeds the input of the internal shift register and is clocked in on each SCK rising edge. Results are therefore passed through each device until they are all received by the digital host. When the status bits are disabled, $16 \times N$ clocks are required to read back N ADCs. When the status bits are enabled, $22 \times N$ clocks are required to read back the conversion data and status bits for N ADCs. The data is valid on both SCK edges.

The maximum achievable conversion rate when using daisy-chain mode is typically less than when reading a single device because the number of bits to clock out is larger (see the Serial Clock Frequency Requirements section).

It is possible to write to each ADC register in daisy-chain mode. The timing diagram is shown in Figure 47. This mode requires 4-wire operation because data is clocked in on the SDI line with CNV held low. The same command byte and register data can be shifted through the entire chain to program all ADCs in the chain with the same register contents, which requires $8 \times (N + 1)$ clocks for N ADCs. It is possible to write different register contents to each ADC in the chain by writing to the furthest ADC in the chain first, using $8 \times (N + 1)$ clocks, and then the second furthest ADC with $8 \times N$ clocks, and so forth until reaching the nearest ADC in the chain, which requires 16 clocks for the command and register data. It is not possible to read register contents in daisy-chain mode.

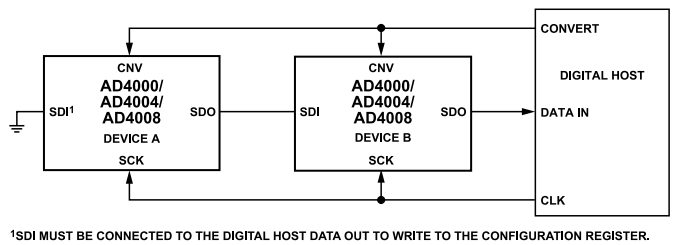

Figure 61. Daisy-Chain Mode, Connection Diagram

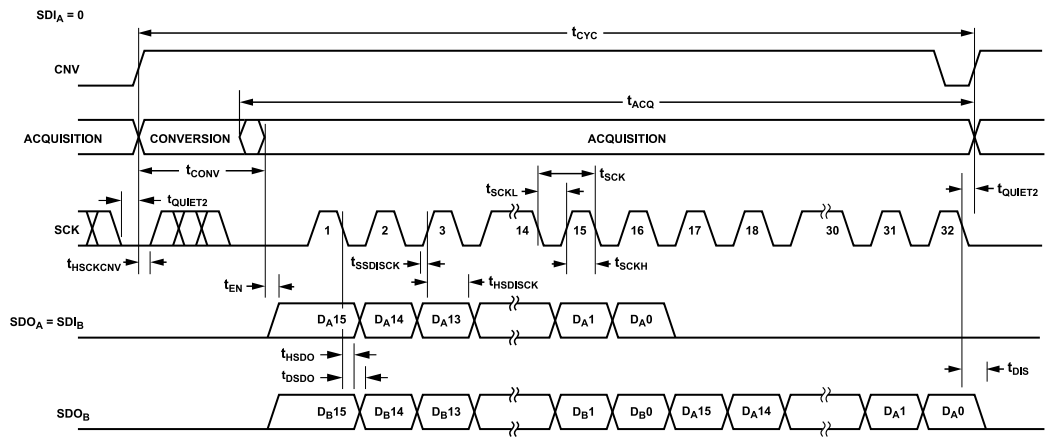

Figure 62. Daisy-Chain Mode, Serial Interface Timing Diagram (Status Bits Not Shown)

APPLICATIONS INFORMATION

LAYOUT GUIDELINES

The PCB that houses the AD4000/AD4004/AD4008 must be designed so that the analog and digital sections are physically separated, such as on opposite sides of the device, as shown in [Figure 63](#). The pinout of the AD4000/AD4004/AD4008, with the analog signals on the left side and the digital signals on the right side, helps to separate the analog and digital signals.

Avoid running digital lines under the device because they couple noise onto the die, unless a ground plane under the AD4000/AD4004/AD4008 is used as a shield. Fast switching signals, such as CNV or clocks, must not run near analog signal paths. Avoid crossover of digital and analog signals.

At least one ground plane must be used. The ground plane can be common or split between the digital and analog sections. In the latter case, join the planes underneath the AD4000/AD4004/AD4008 devices.

The AD4000/AD4004/AD4008 voltage reference input (REF) has a dynamic input impedance. Decouple the REF pin with minimal parasitic inductances by placing the reference decoupling ceramic capacitor close to (ideally right up against) the REF and GND pins and connect them with wide, low impedance traces.

Finally, decouple the VDD and VIO power supplies of the AD4000/AD4004/AD4008 with ceramic capacitors, typically 0.1 μF , placed close to the AD4000/AD4004/AD4008 and connected using short, wide traces to provide low impedance paths and to reduce the effect of glitches on the power supply lines.

An example of the AD4000 layout following these rules is shown in [Figure 63](#) and [Figure 64](#). Note that the AD4004/AD4008 layout is equivalent to the AD4000 layout.

EVALUATING THE AD4000/AD4004/AD4008 PERFORMANCE

Other recommended layouts for the AD4000/AD4004/AD4008 are outlined in the user guide of the evaluation board for the AD4000 ([EVAL-AD4000FMCZ](#)). The evaluation board package includes a fully assembled and tested evaluation board with the AD4000, the [UG-1042](#) user guide, and software for controlling the board from a PC via the [EVAL-SDP-CH1Z](#). The EVAL-AD4000FMCZ can also be used to evaluate the AD4004 and AD4008 by limiting the throughput to 1 MSPS and 500 kSPS, respectively, in its software (see the UG-1042 for more information).

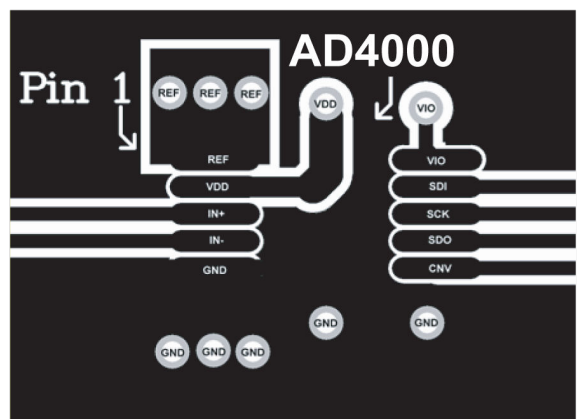

Figure 63. Example Layout of the AD4000 (Top Layer)

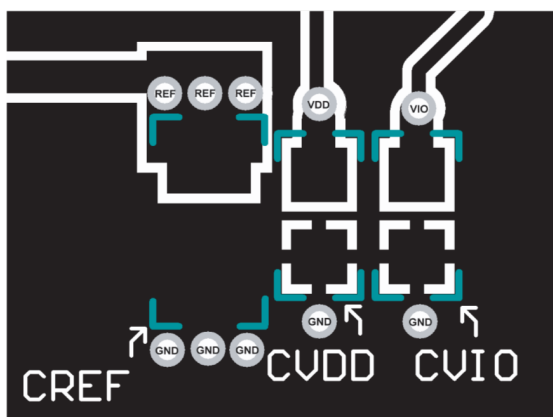

Figure 64. Example Layout of the AD4000 (Bottom Layer)

OUTLINE DIMENSIONS

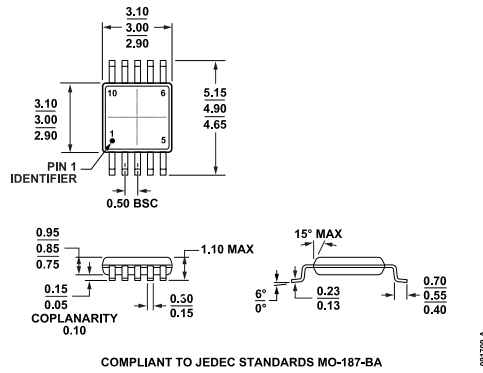

Figure 65. 10-Lead Mini Small Outline Package [MSOP] (RM-10)
 Dimensions shown in millimeters

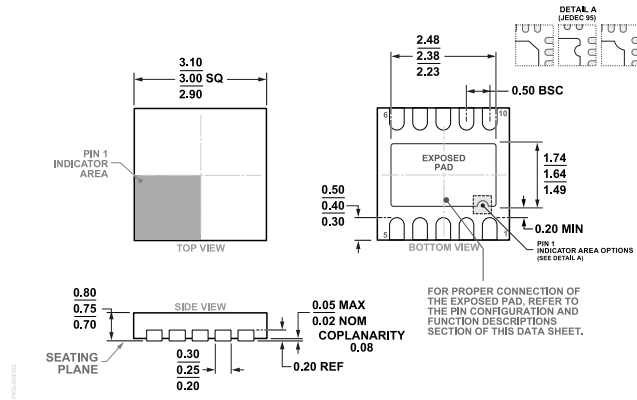

Figure 66. 10-Lead Lead Frame Chip Scale Package [LFCSP] 3 mm x 3 mm Body and 0.75 mm Package Height (CP-10-9)
 Dimensions shown in millimeters

OUTLINE DIMENSIONS

Updated: May 29, 2023

ORDERING GUIDE

Model ¹	Temperature Range	Package Description	Packing Quantity	Package Option	Marking Code
AD4000BCPZ-RL7	-40°C to +125°C	10-Lead LFCSP (3mm x 3mm)	Reel, 1500	CP-10-9	Y61
AD4000BRMZ	-40°C to +125°C	10-Lead MSOP		RM-10	Y61
AD4000BRMZ-RL7	-40°C to +125°C	10-Lead MSOP	Reel, 1000	RM-10	Y61
AD4004BCPZ-RL7	-40°C to +125°C	10-Lead LFCSP (3mm x 3mm)	Reel, 1500	CP-10-9	C8F
AD4004BRMZ	-40°C to +125°C	10-Lead MSOP		RM-10	C8F
AD4004BRMZ-RL7	-40°C to +125°C	10-Lead MSOP	Reel, 1000	RM-10	C8F
AD4008BCPZ-RL7	-40°C to +125°C	10-Lead LFCSP (3mm x 3mm)	Reel, 1500	CP-10-9	C8S
AD4008BRMZ	-40°C to +125°C	10-Lead MSOP		RM-10	C8S
AD4008BRMZ-RL7	-40°C to +125°C	10-Lead MSOP	Reel, 1000	RM-10	C8S

¹ Z = RoHS Compliant Part.

EVALUATION BOARDS

Model ^{1, 2}	Description
EVAL-AD4000FMCZ	AD4000 Evaluation Board Compatible with EVAL-SDP-CH1Z

¹ Z = RoHS Compliant Part.

² The EVAL-AD4000FMCZ can also be used to evaluate the AD4004 and AD4008 by setting the throughput to 1 MSPS and 500 kSPS in its software, respectively (see [UG-1042](#)).

Mouser Electronics

Authorized Distributor

Click to View Pricing, Inventory, Delivery & Lifecycle Information:

[Analog Devices Inc.:](#)

[EVAL-AD4000FMCZ](#) [AD4000BCPZ-RL7](#) [AD4000BRMZ](#) [AD4000BRMZ-RL7](#) [AD4004BRMZ](#) [AD4004BRMZ-RL7](#)
[AD4004BCPZ-RL7](#) [AD4008BCPZ-RL7](#)